



CATÁLOGO 2018

EXPERT-BY-FACOM.COM

EXPERT
by FACOM



EXPERT

by FACOM

EXPERT by FACOM propõe a todos os profissionais da indústria e dos automóveis, soluções com uma relação qualidade/preço justa, robustas e ergonómicas, dedicadas à sua produtividade. Ferramentas direcionadas ao que interessa: a satisfação do trabalho bem feito.

Precisão e segurança

As ferramentas EXPERT são criadas, desenvolvidas e produzidas pelas equipas de I&D e as fábricas FACOM. Correspondem ao máximo às necessidades dos profissionais da manutenção industrial e automóvel.

Resistência, qualidade e ergonomia

EXPERT by FACOM, estas são ferramentas elaboradas para resistir a uma utilização profissional. O design é simples e exclusivo, o conjunto da gama é coerente.

Valor justo, nem mais nem menos

Uma relação qualidade/preço única, para ajudar cada profissional a manter-se competitivo.

Uma gama em conformidade com as normas internacionais



Todas as ferramentas EXPERT by FACOM estão em conformidade com as normas internacionais DIN e ISO em vigor.



Uma marca estruturada com solidez graças aos meios do líder mundial das ferramentas manuais e à sua presença em todo o mundo.

NORTE DA AMÉRICA
Estados Unidos

EUROPA

Alemanha
Áustria
Bélgica
Espanha
França
Grécia
Itália
Países Baixos
Portugal
Reino Unido
Suíça

ESCANDINÁVIA

Dinamarca
Finlândia
Noruega
Suécia

NORTE DA ÁFRICA

Argélia
Marrocos
Tunísia

MEA

Médio Oriente
África

CENTRO LOGÍSTICO EUROPEU SITUADO EM DAMPARIS (JURA - FRANÇA)



2500 REFERÊNCIAS DE FERRAMENTAS PARA A INDÚSTRIA E AUTOMÓVEIS



SERVIÇOS ESSENCIAIS EM EXPERTBYFACOM.COM

- Todas as ferramentas acessíveis na base de dados de produtos
- Catálogo online, brochuras, manuais de utilização
- Cartografia dos pontos de venda para encontrar o ser revendedor mais próximo



ORIENTE DA EUROPA

Bulgária
Hungria
Polónia
República Checa
Rússia
Roménia
Sérvia
Eslovênia

UMA MARCA PROMOVIDA PELAS EQUIPAS COMERCIAIS DA FACOM



GARANTIA EXPERT

Aplica-se a todas as ferramentas da gama, exceto especificações contrárias, sem limite de duração, contra qualquer defeito de fabrico. Dará lugar a uma troca ou uma reparação das peças com defeito, sob condições. Não se aplica em caso de utilização não adequada, modificação das ferramentas, constatada uma manutenção incorreta. O distribuidor autorizado EXPERT ao qual será entregue o produto vai aceitar ou não a aplicação da garantia consoante estas condições e após validação pelo representante ou assistência técnica EXPERT.



ENCONTRE O SEU PRODUTO

ARRUMAÇÃO P.6



CHAVES P.20



ROQUETES - CHAVES DE CAIXA P.46



CHAVES DE FENDAS P.102



APERTO CONTROLADO P.136



FERRAMENTAS ENERGIZADAS P.140



ALICATES P.158



MEDIÇÃO - TRAÇAGEM P.170



MARTELOS P.176



CORTE P.184



ILUMINAÇÃO P.194



TUBAGEM - MANUTENÇÃO P.202



ELECTRICIDADE - ELECTRÓNICA P.212



FERRAMENTAS AUTOMÓVEL P.226



SOLUÇÕES PARA O DISTRIBUIDOR P.264



ARRUMAÇÃO





Carros

P.8



Modulos

P.11



Móveis oficina

P.13



Acessórios

P.14



Carrinhos de oficina

P.14



Baús

P.15



Caixas de ferramentas

P.16



Composição multi-ferramentas

P.18





CARROS DE FERRAMENTA

CARRO GRANDE DE 7 GAVETAS - 4 MÓDULOS POR GAVETA

- 7 gavetas: 4 de 60 mm altura e 3 de 130 mm altura.
- Cada gaveta pode receber 4 módulos.
- Abertura das gavetas a 100%.
- Carga por gaveta: 20 kg para as gavetas de 60 mm e 25 kg para as gavetas de 130 mm.
- Fecho centralizado.
- Plano de trabalho revestido com uma placa ABS de 2 mm amovível – Resistência a uma carga estática de 800 Kg.
- Pega em polipropileno.
- Quatro rodas com 125 mm de diâmetro; 2 fixas e 2 giratórias, das quais uma com travão.
- Dimensões totais (com pega): L.1005 x P.500 x A.987 mm.
- Dimensões (sem pega): L.920 x P.500 x A.987 mm.
- Dimensões úteis das gavetas: L.760 x P.420 mm.



LONGO

E010101	L mm	P mm	H mm	Peso kg		EAN
E010101	1005	500	987	95	1	3258950101019

CARRO GRANDE 8 GAVETAS - 4 MÓDULOS POR GAVETA

- 8 gavetas: 6 de 60 mm altura e 2 de 130 mm altura.
- Cada gaveta pode receber 4 módulos.
- Abertura das gavetas a 100%.
- Carga por gaveta: 20 kg para as gavetas de 60 mm e 25 kg para as gavetas de 130 mm.
- Fecho centralizado.
- Plano de trabalho revestido com uma placa ABS de 2 mm amovível – Resistência a uma carga estática de 800 Kg.
- Pega em polipropileno.
- Quatro rodas com 125 mm de diâmetro; 2 fixas e 2 giratórias, das quais uma com travão.
- Dimensões totais (com pega): L.1005 x P.500 x A.987 mm.
- Dimensões (sem pega): L.920 x P.500 x A.987 mm.
- Dimensões úteis das gavetas: L.760 x P.420 mm.



LONGO

E010131	L mm	P mm	H mm	Peso kg		EAN
E010131	1005	500	987	81,10	1	3258950101316



CARRO DE FERRAMENTAS

CARRO 6 GAVETAS - 3 MÓDULOS POR GAVETA

- Carro 6 gavetas: 3 gavetas com 60 mm de altura. 2 gavetas com 130 mm de altura. 1 gaveta com uma altura: 200 mm. As gavetas podem ser equipadas com todos os módulos termoformados ou espuma do programa EXPERT – 3 módulos por gaveta. Carga máxima por gaveta: 20/25/30 kg.
- Superfície de trabalho: Grande superfície de trabalho em polipropileno com fibra (resistência a uma carga estática de 700 kg), com pega integrada e rebordos integrados que evitam a queda de ferramentas durante a deslocação. Resistência aos impactos e aos hidrocarbonetos. Localização dedicada para 3 chaves e alvéolos para parafusos e peças pequenas.
- Segurança: Fachada de gavetas basculante em polipropileno com ganchos de segurança. Sem risco de abertura durante a deslocação. Fechadura posicionada na parte lateral. Fecho centralizado por fechadura com chave, entregue com 2 chaves das quais 1 articulada
- Manobrabilidade: 4 rodas diâm. 125 mm, 2 giratórias (das quais uma com travão) e 2 fixas. Carro entregue com as rodas montadas.
- Acessórios: Suporte frascos incluído (posicionável à direita ou à esquerda).
- Dimensões totais rodas e superfície de trabalho incluídas (C. x P. x A.): 748 x 515 x 970 mm.
- Dimensões úteis das gavetas (C. x P. x A.): 569 x 421 x 60/130/200 mm.

E010192	L mm	P mm	H mm	Peso g	☒	EAN
E010192	748	515	970	54	1	3258950101927



CARRO 7 GAVETAS - 3 MÓDULOS POR GAVETA

- Carro 7 gavetas: 4 gavetas com 60 mm de altura. 3 gavetas com 130 mm de altura. As gavetas podem ser equipadas com todos os módulos termoformados ou espuma do programa EXPERT - 3 módulos por gaveta. Carga máxima por gaveta: 20/25 kg.
- Superfície de trabalho: Grande superfície de trabalho em polipropileno com fibra (resistência a uma carga estática de 700kg), com pega integrada e rebordos integrados que evitam a queda de ferramentas durante a deslocação. Resistência aos impactos e aos hidrocarbonetos. Localização dedicada para 3 chaves e alvéolos para parafusos e pequenas peças.
- Segurança: Fachada de gavetas basculante em polipropileno com ganchos de segurança. - Sem risco de abertura durante a deslocação. Fechadura posicionada na parte lateral. Fecho centralizado por fechadura com chave, entregue com 2 chaves, das quais 1 é articulada.
- Manobrabilidade: 4 rodas diâm. 125 mm, 2 giratórias (das quais uma com travão) e 2 fixas. Carro entregue com as rodas montadas.
- Acessórios: Suporte frascos incluído (posicionável à direita ou à esquerda).
- Dimensões totais rodas e superfície de trabalho incluídas (C. x P. x A.): 748 x 515 x 970 mm.
- Dimensões úteis das gavetas (C. x P. x A.): 569 x 421 x 60/130/200 mm.

E010193	L mm	P mm	H mm	☒	EAN
E010193	748	515	970	1	3258950101934





SERVANTES ET COFFRE MOBILE

CARRO 7 GAVETAS, COM COMPARTIMENTO – 3 MÓDULOS POR GAVETA

- Carro 7 gavetas: 6 gavetas com 60 mm de altura. 1 gaveta com 270 mm de altura. As gavetas podem ser equipadas com todos os módulos termoformados ou espuma do programa EXPERT - 3 módulos por gaveta. Carga máxima por gaveta: 20/30 kg
- Superfície de trabalho: Grande superfície de trabalho em polipropileno com fibra (resistência a uma carga estática de 700kg), com pega integrada e rebordos integrados que evitam a queda de ferramentas durante a deslocação. Resistência aos impactos e aos hidrocarbonetos. Localização dedicada para 3 chaves e alvéolos para parafusos e peças pequenas
- Segurança: Fachada de gavetas basculante em polipropileno com ganchos de segurança. Sem risco de abertura durante a deslocação. Fechadura posicionada na parte lateral. Fecho centralizado por fechadura com chave, entregue com 2 chaves, das quais 1 é articulada
- Manobrabilidade: 4 rodas diâm. 125 mm, 2 giratórias (das quais uma com travão) e 2 fixas. Carro entregue com as rodas montadas.
- Acessórios: Suporte frascos incluído (posicionável à direita ou à esquerda).
- Dimensões totais rodas e superfície de trabalho incluídas (C. x P. x A.): 748 x 515 x 970 mm.
- Dimensões úteis das gavetas (C. x P. x A.): 569 x 421 x 60/130/200 mm.



	L mm	P mm	H mm		EAN
E010194	748	515	970	1	3258950101941



O SISTEMA MODULAR EXPERT

As caixas e módulos Expert foram desenvolvidos para oferecer uma arrumação fácil e otimizada para as vossas ferramentas dentro das gavetas dos carros.

Os carros Expert aceitam 3 ou 4 módulos, a fim de responder às vossas necessidades de capacidade de arrumação de ferramenta.

Dentro de uma mesma gaveta você pode arrumar desde caixas de ferramenta abertas ou fechadas, sem nenhuma perda de espaço.

Todas as suas ferramentas estão assim disponíveis e arrumadas numa gaveta, a fim de otimizar o vosso tempo de trabalho.

Para mais detalhes sobre as caixas EXPERT, páginas 48-49.



Dimensões de modules standards : 185 x 240 cm.



Módulo : E194937

Tabuleiro vazio : E113557
Page : 25



Módulo : E110302

Tabuleiro vazio : E010508
Page : 25



Módulo : E111100

Tabuleiro vazio : E010509
Page : 33



Módulo : E194938

Tabuleiro vazio : E195064
Page : 33

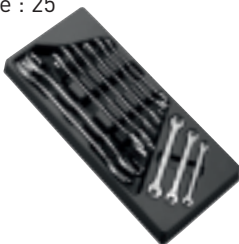

Módulo : E111220

Tabuleiro vazio : E111221
Page : 35



Módulo : E111710

Tabuleiro vazio : E111711
Page : 38



Módulo : E034853

Tabuleiro vazio : E034854
Page : 50

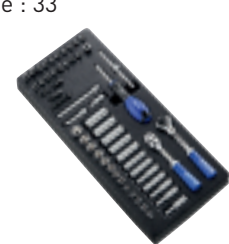

Módulo : E030715

Tabuleiro vazio : E030716
Page : 57



Módulo : E194680

Tabuleiro vazio : E030701
Page : 57



Módulo : E194678

Tabuleiro vazio : E031802
Page : 67



Módulo : E031821

Tabuleiro vazio : E031822
Page : 67



Módulo : E032922

Tabuleiro vazio : E032923
Page : 81





ARRUMAÇÃO



Módulo : E194677
Tabuleiro vazio : E032901
Page : 81



Módulo : E032201
Tabuleiro vazio : E010515
Page : 81



Módulo : E032924
Tabuleiro vazio : E032925
Page : 81



Módulo : E231101
Tabuleiro vazio : E231105
Page : 149



Módulo : E041604
Tabuleiro vazio : E041606
Page : 150



Módulo : E040601
Tabuleiro vazio : E040602
Page : 150



Módulo : E041644
Tabuleiro vazio : E041645
Page : 150



Tabuleiro vazio :
E010516



Módulo : E194940
Tabuleiro vazio : E160916
Page : 106



Módulo : E194941
Tabuleiro vazio : E160917
Page : 107



Módulo : E121609
Tabuleiro vazio : E121205
Page : 123

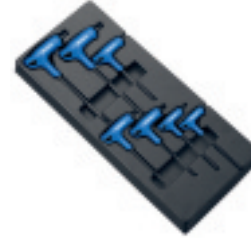

Módulo : E121706
Tabuleiro vazio : E121214
Page : 125



Módulo : E121105
Tabuleiro vazio : E121106
Page : 127



Tabuleiro vazio :
E131704



Módulo : E080821
Tabuleiro vazio : E010537
Page : 161



Módulo : E080801
Tabuleiro vazio : E010504
Page : 161



Módulo : E194944
Tabuleiro vazio : E010504
Page : 161



Módulo : E194943
Tabuleiro vazio : E010503
Page : 166



Módulo : E150801
Tabuleiro vazio : E010501
Page : 178



Módulo : E150802
Tabuleiro vazio : E010506
Page : 178



Módulo : E150803
Tabuleiro vazio : E010507
Page : 178



Módulo : E090302
Tabuleiro vazio : E010519
Page : 172



Módulo : E142401
Tabuleiro vazio : E142402
Page : 172



Módulo : E020611
Tabuleiro vazio : E010514
Page : 187



MÓVEIS OFICINA

BANCADA DE MADEIRA

- Comprimento da superfície de trabalho: 1,5 m ou 2 m.
- Superfície de trabalho em madeira (espessura 28 mm).
- Resistência estática: 800 kg.
- Altura: 850 mm.
- Possibilidade de adicionar uma gaveta para as bancadas de 1,5 m e duas gavetas para as bancadas de 2 m (E010405).



E010402	Peso kg		EAN
E010402	76	1	3258950104027

BANCADA DE METAL

- Comprimento da superfície de trabalho: 1,5 m ou 2 m.
- Superfície de trabalho em metal (espessura 2 mm).
- Resistência estática: 800 kg.
- Altura: 850 mm.
- Possibilidade de adicionar uma gaveta para as bancadas de 1,5 m e duas gavetas para as bancadas de 2 m (E010405).



E010404	Peso kg		EAN
E010404	77	1	3258950104041

GAVETA PARA BANCADAS

- Fecho por fechadura com chave.
- Gaveta para bancadas: E010401-E010402-E010403-E010404
- Dimensões: 570x420x175 mm.

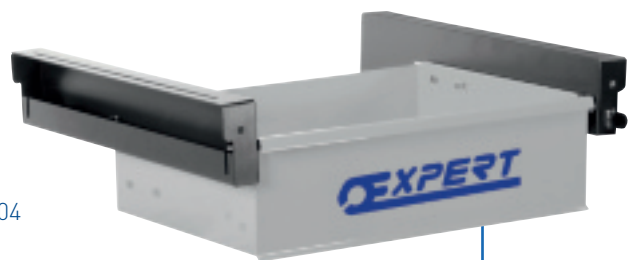

E010405	Peso kg		EAN
E010405	4	1	3258950104058





ACESSÓRIOS DE OFICINA

TABULEIROS MAGNÉTICOS EXTENSÍVEIS

- Fundo com ímã para uma fixação eficaz dos parafusos e outras pequenas peças metálicas.
- Pode ser utilizado na horizontal ou vertical.
- Capacidade extensível em função das necessidades.
- Retrátil, pode arrumar-se dentro de uma gaveta de carro.
- E010128 - altura: de 35 a 92 mm; diâmetro 135 mm.
- E010129 - altura: de 42 a 130 mm; diâmetro 225 mm.

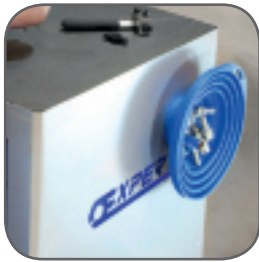

	Peso g	☒	EAN
E010128	132	1	3258950101286
E010129	510	1	3258950101293

CARRINHOS DE OFICINA

CARRINHO DE OFICINA EM ALUMÍNIO E PLÁSTICO

- Construção em plástico e alumínio.
- 4 rodas giratórias, das quais 2 com travão para uma deslocação e uma fixação facilitadas.
- Carga máxima: 150 kg.



	L mm	P mm	H mm	Peso kg	☒	EAN
E010136	752	470	965	11,5	1	3258950101361



CARRO DE OFICINA COM RODAS

- Pega de manobra confortável.
- Superfície de trabalho e prateleiras com rebordos que evitam a queda das ferramentas e equipados com tapete anti-derrapante em borracha.
- 2 rodas giratórias e 2 fixas Ø 80 mm para uma deslocação e uma fixação facilitadas.
- Carga máxima: 200 Kg.



	L mm	P mm	H mm	Peso kg		EAN
E010108	925	495	120	22,3	1	3258950101088

BAÚS

BAÚS DE ESTALEIRO

- Fabricado em chapa de aço espessa.
- Equipado com dobradiças de eixo articulado, a tampa abre-se a 95°.
- Equipado com 2 pegas laterais para o transporte.
- Entregue com um tabuleiro amovível em chapa.
- Bloqueável por cadeado (não fornecido).
- Piso fixo: 4 furos na parte inferior do tronco.



	L mm	P mm	H mm	Peso kg		EAN
E010209	520	290	294	7	1	3258950102092
E010202	650	366	353	11,50	1	3258954102029
E010203	850	360	353	12,10	1	3258953102037
E010204	1000	405	450	16,60	1	3258954102043





CAIXAS DE FERRAMENTAS

CAIXA METÁLICA 5 DIVISÕES 45 E 53,5 CM

- 2 pegas articuladas.
- 5 compartimentos em 3 níveis.
- Bloqueável por cadeado (não fornecido).
- Facilidade de abertura.
- Dimensões (com pega)
 - caixa 450 mm: L.490 x P.250 x A.230 mm -
 - caixa 535 mm: L.575 x P.250 x A.230 mm.
- Fundo dimensão interior da
 - caixa 450 mm: L.448 x P.200 x A.98 mm -
 - caixa 535 mm: L.518 x P.200 x A.98 mm.
- Compartimentos dimensão interior
 - da caixa 450 mm: L.448 x P.100 x A.55 mm -
 - caixa 535 mm: L.526 x P.100 x A.55 mm.



	L mm	P mm	H mm	Peso kg	☒	EAN
E194738	450	250	230	4	1	3258951947388
E010201	535	250	230	5,20	1	3258950102016

CAIXA PLÁSTICA 41 E 49 CM

- Tampa equipada com 3 compartimentos de arrumação transparentes, dos quais 2 são amovíveis.
- Tabuleiro amovível.
- 2 fechos metálicos.
- Bloqueável por cadeado (não fornecido).
- Pega escamoteável.
- Capacidade de carga da caixa 41 cm: 8 kg - caixa 49 cm: 10 kg.



	L mm	P mm	H mm	Peso g	☒	EAN
E010304	410	255	182	1250	1	3258950103044
E010305	490	285	240	1682	1	3258950103051



CAIXA DE FERRAMENTAS EM TECIDO

- Tecido resistente 600 x 600 denier.
- Bolsas plásticas no interior e no exterior.
- Arrumação ajustável para serrote.
- Fecho por capota flexível dobrável numa bolsa.
- Pega em aço com zona de conforto.
- Correia ajustável.
- Fundo rígido e estanque.
- Capacidade de carga 10 kg.



	L mm	P mm	H mm	Peso kg		EAN
E010601	465	215	310	2,57	1	3258950106014

MOCHILA COM RODAS

- Tecido resistente 600 x 600 denier.
- Ideal para a manutenção itinerante.
- Bolsas interiores e compartimentos.
- Bolsas na parte frontal e nos lados.
- Alças reguláveis forradas com pega de transporte na parte superior.
- Pega telescópica e rodas integradas.



	L mm	P mm	H mm	Peso kg		EAN
E010602	338	218	470	3,68	1	3258950106021





COMPOSIÇÃO MULTI-FERRAMENTAS

MALA DE MANUTENÇÃO 96 FERRAMENTAS

- Chaves mistas 8 - 10 - 11 - 12 - 13 - 14 - 16 - 17 - 18 - 19 mm.
- 1 chave crescente 250 mm.
- 1/4": Chaves de caixa 4 - 5 - 5,5 - 6 - 7 - 8 - 9 - 10 - 11 - 12 - 13 mm. 1 roquete - cardan. 1 pega corrediça. 2 extensões 55-100 mm. 1 chave de caixa porta-pontas 1/4". 1 pega com cabo.
- 1/2": Chaves de caixa 10 - 11 - 12 - 13 - 14 - 15 - 16 - 17 - 18 - 19 - 22 mm. 1 roquete - cardan. 2 extensões 75-250 mm.
- Chaves: Fenda 3,5 x 75 - 4 x 100 - 6,5 x 150 - 8 x 175. Phillips® PH 1-2 - Pozidriv® PZ 1-2.
- Caixa de aparafusamento 19 peças.
- Jogo de 9 chaves macho sextavadas.
- Jogo de 7 chaves macho Torx®.
- 1 alicate de pontas 1/2 redondos longos.
- 1 alicate de corte diagonal.
- 1 alicate ajustável.
- 1 martelo de pena 32 mm.
- 1 saca-troços 4 - 6 mm.
- 1 punção 4 mm.
- 1 armação de serrote.
- 1 fita métrica 5 m.



	Peso kg		EAN
E220104	8,6	1	3258952201045

MALA DE MANUTENÇÃO 142 FERRAMENTAS

- Chaves mistas 8 - 9 - 10 - 11 - 12 - 13 - 14 - 16 - 17 - 18 - 19 mm.
- 1 chaves mistas 250 mm.
- 1/4" : Chaves de caixa 4 - 5 - 5,5 - 6 - 7 - 8 - 9 - 10 - 11 - 12 - 13 mm. 1 roquete - cardan. 2 extensões 55 - 100 mm. 1 chave de caixa porta-pontas 1/4". 1 pega com cabo.
- 1/2" : Chaves de caixa 10 - 11 - 12 - 13 - 14 - 15 - 16 - 17 - 18 - 19 - 20 - 22 - 24 - 27 - 30 - 32 mm. 1 roquete - cardan. 2 extensões 75-250 mm.
- Chaves: Fenda 2,5 x 50 - 3,5 x 75 - 4 x 100 - 5,5 x 125 - 6,5 x 150 - 8 x 175 - Phillips® PH 1-2 - Pozidriv® PZ 1-2.
- 1 chave busca polos.
- 1 caixa de aparafusamento 49 peças..
- Jogo de 9 chaves macho sextavadas.
- Jogo de 7 chaves macho Torx®.
- 1 alicate de pontas 1/2 redondos longos.
- 1 alicate universais.
- 1 alicate de corte diagonal.
- 1 alicate ajustaveis
- 1 alicate para descarnar.
- 1 alicate para.
- 1 turquesas russas 250 mm.
- 1 martelo de penair 32 mm.
- 1 saca-troços 4-5-6 mm.
- 1 serrote de arco.
- 1 cutter 18 mm
- 1 ponteiros de traçar.
- 1 punção 4 mm.
- 1 fita métrica 5 m.
- 1 paquímetro 1/20e.



	Peso kg		EAN
E220107	13,6	1	3258952201076

**COMPOSIÇÃO MULTI-FERRAMENTAS - 124 PEÇAS**

- Chaves de caixa sextavadas 1/4": 4-4,5-5-5,5-6-7-8-9-10-11-12-13-14 mm.
- 2 roquetes parquímetro de bloqueio 1/4" e 1/2".
- 2 extensões 1/4": 55-100 mm e 2 extensões 1/2": 130-250 mm.
- 2 cardans 1/4" e 1/2".
- 1 adaptador 1/4" para pontas 1/4".
- 1 pega com cabo 1/4".
- 1 alicate ajustável entrecassado 250 mm.
- 1 alicate de corte diagonal mecânico 160 mm.
- 1 alicate de pontas 1/2" redondas - curvas 40°.
- Chaves de caixa sextavadas 1/2": 10-11-12-13-14-15-16-17-18-19-21-22-24-27-30-32 mm.
- Chaves mistas: 8-10-11-12-13-14-15-16-17-18-19 mm.
- Jogo de 9 chaves macho curtas num estojo: 1,5-2-2,5-3-4-5-6-8-10 mm.
- Jogo de 7 chaves macho Torx® num estojo: T10-T15-T20-T25-T27-T30-T40 mm.
- Chaves: - fenda: 4x100-6,5x125 - Phillips®: PH1x100-PH2x125 - Pozidriv®: PZ1x100-PZ2x125.
- Caixa de 48 pontas e 1 acessório: - fenda: 4-4,5-5-5,5-6,5x2-8 mm - Phillips®: PH1x2-PH2x3-PH3 - Pozidriv®: PZ1x2-PZ2x3-PZ3x2 - Torx®: T10x2-T15x2-T20x2-T25x2-T30x2 - ResisTorx®: TT10-TT15x2-TT20x2-TT25x2-TT30x2-TT40 - sextavadas: 2-3x2-4x2-5x2-6x2 mm.
- 1 porta-pontas magnético com anel de fixação.



	Dimensões mm	Peso kg		EAN
E034806	L.565 x P.415 x H.92	8,30	1	3258950348063

COMPOSIÇÃO MULTI-FERRAMENTAS - 126 PEÇAS

- Chaves de caixa sextavadas 1/4" métricas: 4-4,5-5-5,5-6-7-8-9-10-11-12-13-14 mm.
- Chaves de caixa sextavadas 1/4" métricas: 4-5-5,5-6-7-8-9-10-11-12-13-14 mm.
- Chaves de caixa sextavadas 1/4" em polegadas: 3/16"-7/32"-1/4"-9/32"-5/16"-11/32"-3/8"-7/16"-1/2"-9/16".
- Chaves de caixa longas sextavadas 1/4" em polegadas: 3/16"-7/32"-1/4"-9/32"-5/16"-11/32"-3/8"-7/16"-1/2"-9/16".
- Chaves de caixa sextavadas 3/8" métricas: 10-11-12-13-14-15-16-17-18-19 mm.
- Chaves de caixa sextavadas 3/8" métricas: 10-11-12-13-14-15-16-17-18-19 mm.
- Chaves de caixa sextavadas 3/8" em polegadas: 1/4"-5/16"-11/32"-3/8"-7/16"-1/2"-9/16"-5/8"-11/16"-3/4"-13/16"-7/8"-15/16"-1".
- Chaves de caixa longas sextavadas 3/8" em polegadas: 1/4"-5/16"-3/8"-7/16"-1/2"-9/16"-5/8"-11/16"-3/4"-13/16"-7/8"-15/16"-1".
- Chaves mistas métricas: 10-11-12-13-14-15-16-17-18-19 mm.
- Chaves mistas em polegadas: 5/16"-11/32"-3/8"-7/16"-1/2"-9/16"-5/8"-11/16"-3/4".
- 2 roquetes parquímetro de bloqueio 1/4" e 3/8".
- 2 extensões 1/4": 55-150 mm e 1 extensão 3/8": 125 mm.
- 2 cardans 1/4" e 3/8".
- Aumentador 1/4" - 3/8".
- Redutor 3/8" - 1/4".
- Chaves: - fendas: 3x50 - 4x100 - 5,5x125. - Phillips®: PH0x75 - PH1x100 - PH2x125.



	Dimensões mm	Peso kg		EAN
E034835	L.565 x P.415 x H.92	9,7	1	3258950348353



CHAVES





Chaves mistas

P.22



Chaves mistas de roquete

P.28



Chaves de Luneta com roquete

P.32



Chaves de roquete 4 em 1

P.32



Módulos de chaves de roquete

P.33



Chaves de bocas DIN

P.36



Chaves de bocas

P.34



Chaves de bocas DIN

P.36



Chaves de luneta

P.37



Chaves tipo cachimbo

P.39



Chaves de tubos dobrada

P.40



Chaves luneta aberta

P.42



Chaves francesas

P.43



Chaves de pinos

P.45



Chaves para andaimes

P.45





CHAVES MISTAS

CHAVES MISTAS - MM

→ ISO 691 - ISO 1711-1 - ISO 3318 - ISO 7738 - DIN 3113

→ Cabeça poligonal 12 faces inclinada a 15°.

→ Concebidas para serem inseridas nas gavetas de um carro.

→ Perfil da luneta que maximiza a superfície de contacto com a porca para uma longevidade acrescida.

→ Forjadas a partir de aço de cromo-vanádio.

→ Acabamento: cromado, póliido.

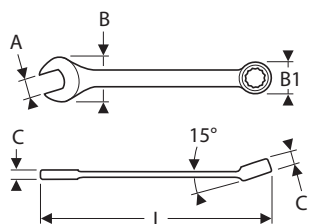

	A mm	B mm	B1 mm	C mm	C1 mm	L mm	Peso g	☒	EAN
E113228	5	14.7	9	3.4	4	93	15	1	3258951132289
E113229	5.5	14.7	9	3.4	4	93	15	1	3258951132296
E113202	6	16.2	10.4	3.7	4.5	100	20	1	3258951132029
E113200	7	18.2	11.7	3.7	5	110	20	1	3258951132005
E113201	8	20.2	13.2	4	5	120	25	1	3258951132012
E113204	9	22.2	14.6	4	6	130	35	1	3258951132043
E113205	10	23.7	16	4	6.5	140	37	1	3258951132050
E113206	11	25.7	17	4.7	6.5	150	45	1	3258951132067
E113207	12	27.5	19	4.8	7	160	60	1	3258951132074
E113208	13	28.7	20.6	5.5	7.5	170	67	1	3258951132081
E113209	14	31.7	22	5.6	8	180	80	1	3258951132098
E113210	15	34	23.4	5.7	8.5	190	95	1	3258951132104
E113211	16	36	24.8	5.8	9	200	110	1	3258951132111
E113212	17	38.5	26.2	6.3	9.5	210	123	1	3258951132128
E113213	18	39	27.6	6.8	10	220	150	1	3258951132135
E113214	19	42.2	29	7.1	10.4	230	165	1	3258951132142
E113215	20	42.7	30.2	7.2	10.9	240	180	1	3258951132159
E113216	21	45.5	31.7	7.5	11.4	250	185	1	3258951132166
E113217	22	48.7	33	8	11.9	260	242	1	3258951132173
E113218	23	48.7	33	8	11.9	260	235	1	3258951132180
E113219	24	50.7	35	8	12.9	280	280	1	3258951132197
E113220	25	52.7	38	8	13.4	295	325	1	3258951132203
E113221	26	52.7	38	8	13.4	295	325	1	3258951132210
E113222	27	56.2	40	8.9	14.4	310	370	1	3258951132227
E113223	28	60.2	44.6	9	15.9	340	495	1	3258951132234
E113224	29	60.2	44.6	9	15.9	340	495	1	3258951132241
E113225	30	60.2	44.6	9	15.9	340	485	1	3258951132258
E113226	32	64.7	47.3	10.6	16	360	600	1	3258951132265
E110101	34	68.7	49.3	11.5	17.2	380	639	1	3258951101018
E110102	36	73	53.4	13	18.2	410	809	1	3258951101025
E110103	38	76	56.5	14.5	19	430	965	1	3258951101032



CHAVES MISTAS - POLEGADAS

→ ASME B 107-100

- Cabeça poligonal 12 faces inclinada a 15°.
- Concebidas para serem inseridas nas gavetas de um carro.
- Perfil do olhal que maximiza a superfície de contacto com a porca para umalongevidade acrescida.
- Forjadas a partir de aço de cromo-vanádio.
- Acabamento: cromado, póliido.

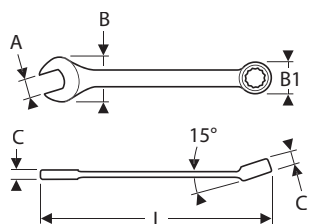
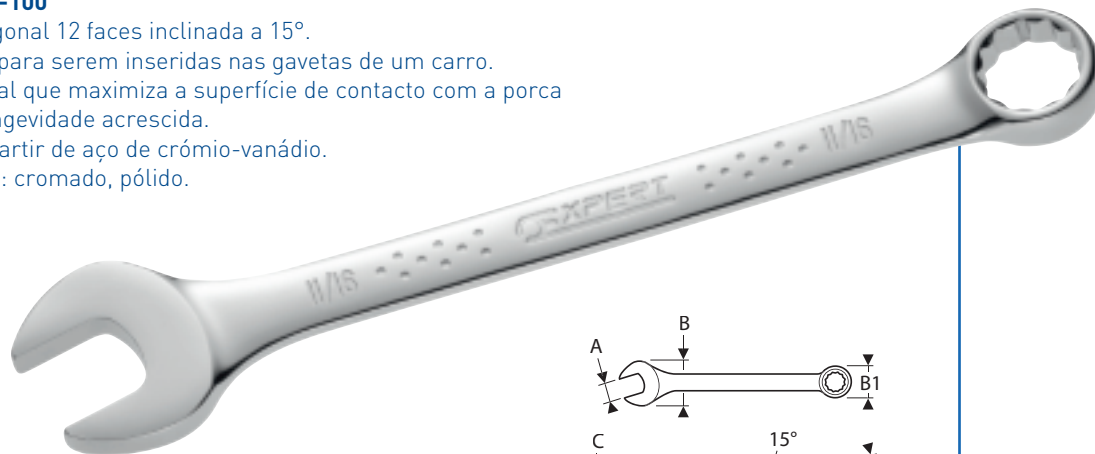

	A"	B mm	B1 mm	C mm	C1 mm	L mm	Peso g	☒	EAN
E113312	1/4"	16.2	10.4	3.7	4.5	100	15	1	3258951133125
E113230	5/16"	20.2	13.2	4	5	120	26	1	3258951132302
E113313	11/32"	22.2	14.6	4	6	130	30	1	3258951133132
E113314	3/8"	23.7	16	4	6.5	140	38	1	3258951133149
E113315	7/16"	25.7	17	4.7	6.5	150	46	1	3258951133156
E113316	1/2"	28.7	20.6	5.5	7.5	170	68	1	3258951133163
E113317	9/16"	31.7	22	5.6	8	180	79	1	3258951133170
E113318	5/8"	36	24.8	5.8	9	200	110	1	3258951133187
E113358	3/4"	42.2	29	7.1	10.4	230	150	1	3258951133583
E113359	13/16"	45.5	31.7	7.5	11.4	250	194	1	3258951133590
E113360	7/8"	48.7	33	8	11.9	260	225	1	3258951133606
E113235	15/16"	50.7	35	8	12.9	280	293	1	3258951132357
E113236	1"	52.7	38	8	13.4	295	328	1	3258951132364
E113319	11/16"	38.5	26.2	6.3	9.5	210	141	1	3258951133194
E113361	1"1/16	56.2	40	8.9	14.4	310	386	1	3258951133613
E113362	1"1/8	60.2	44.6	9	15.9	340	503	1	3258951133620
E113363	1"1/4	64.7	47.3	10.6	16	360	602	1	3258951133637
E110201	1"5/16	68.7	49.3	11.5	17.2	380	632	1	3258951102015
E110202	1"3/8	73	53.4	13	18.2	410	806	1	3258951102022
E110203	1"7/16	73	53.4	13	18.2	410	804	1	3258951102039
E110204	1"1/2	76	56.5	14.5	19	430	992	1	3258951102046
E110205	1"5/8	83.5	61.5	15.5	20	480	1264	1	3258951102053
E110206	1"7/8	101.5	73.5	17.2	22.6	540	2110	1	3258951102060





CHAVES MISTAS

JOGOS DE CHAVES MISTAS



	Conteúdo	Recipiente	Qtd	Peso g		EAN
E110300	8-10-11-13-17-19-22-24 mm.	Caixa papelão	8	1122	1	3258951103005
E113241	1/4"-5/16"-3/8"-7/16"-1/2"-9/16"-5/8"-11/16"-3/4"	Caixa papelão	9	851	1	3258951132418
E110310	10-11-12-13-14-15-16-17-18-19 mm.	Suporte plástico	10	1080	1	3258951103104
E110309	7-8-10-11-12-13-16-17-18-19-22-24 mm.	Suporte plástico	12	1495	1	3258951103098
E110327	7-8-10-11-12-13-16-17-18-19-22-24 mm.	Estojo	12	1495	1	3258951103272
E113242	1/4"-5/16"-3/8"-7/16"-1/2"-9/16"-5/8"-11/16"-3/4"-13/16"-7/8"-15/16"	Caixa papelão	12	1580	1	3258951132425
E113238	8-9-10-11-12-13-14-15-16-17-18-19-20-21-22-24 mm.	Suporte plástico	16	1894	1	3258951132388
E113239	6-7-8-9-10-11-12-13-14-15-16-17-18-19-20-21-22-24 mm.	Caixa papelão	16	1646	1	3258951132395
E110313	6-7-8-9-10-11-12-13-14-15-16-17-18-19-20-21-22-24 mm.	Estojo	18	2035	1	3258951103135
E113240	6-7-8-9-10-11-12-13-14-15-16-17-18-19-20-21-22-24 mm.	Caixa papelão	18	2022	1	3258951132401
E110306	6-7-8-9-10-11-12-13-14-15-16-17-18-19-20-21-22-24-27-30-32 mm.	Caixa papelão	21	3450	1	3258951103067
E110326	6-7-8-9-10-11-12-13-14-15-16-17-18-19-20-21-22-24-26-27-30-32 mm.	Estojo	22	3998	1	3258951103265
E110323	6-7-8-9-10-11-12-13-14-15-16-17-18-19-20-21-22-23-24-25-26-27-28-29-30-32 mm.	Caixa papelão	26	4600	1	3258951103234



MÓDULOS DE CHAVES MISTAS

- Tabuleiro termoformado.
- Concebidas para serem inseridas nas gavetas de um carro.
- Tabuleiro vazio para módulo E194937: E113557.
- Tabuleiro vazio para módulo E110302: E010508.



	Conteúdo	Qty	Peso g	☐	EAN
E110302	27-29-30-32 mm.	4	2230	1	3258951103029
E194937	6-7-8-9-10-11-12-13-14-15-16-17-18-19-22-24 mm.	16	1850	1	3258951949375

JOGO DE 7 CHAVES MISTAS CURTAS - MM

- Fornecido em expositor plástico.



	Conteúdo	Qty	Peso g	☐	EAN
E110304	10-12-13-14-15-17-19 mm.	7	640	1	3258951103043





CHAVES MISTAS

CHAVES MISTAS LONGAS - MM

- ISO 691 - ISO 1711-1
- Ângulo de retoma de 5°.
- Cabeça poligonal 12 faces inclinada a 15°.
- Chave de boca com ângulo de 15° em relação ao eixo do cabo (ângulo de inclinação de 30°).
- Perfil da luneta que maximiza a superfície de contacto com a porca para uma longevidade acrescida.
- Forjadas a partir de aço de cromo-vanádio.
- Chaves alongadas para uma potência de aperto acrescida.
- Acabamento: cromado, pólido.

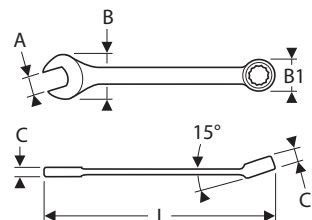
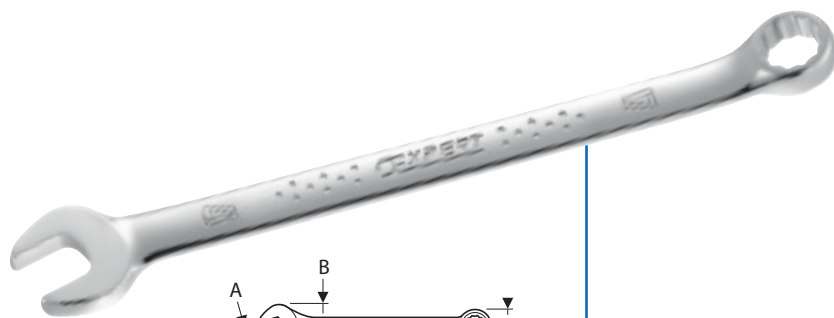

	A mm	B mm	B1 mm	C mm	C1 mm	L mm	Peso g	☒	EAN
E110701	8	17.7	13.3	4.2	6.4	148	35	1	3258951107010
E110702	9	20.5	14.8	5	7.1	167	45	1	3258951107027
E110703	10	21.8	16	5.4	7.4	172	50	1	3258951107034
E110704	11	24.2	17.3	5.5	8	186	60	1	3258951107041
E110705	12	26.5	18.5	5.7	8.4	197	75	1	3258951107058
E110706	13	27.4	19.7	6.1	8	207	85	1	3258951107065
E110707	14	30.7	22.1	6.7	9	223	100	1	3258951107072
E110708	15	32	23.1	7	9.9	233	120	1	3258951107089
E110709	16	34.5	24.1	7.3	10.6	243	140	1	3258951107096
E110710	17	37	26.4	8.1	11.2	261	155	1	3258951107102
E110711	18	39.1	27.5	8.4	11.4	270	190	1	3258951107119
E117701	21	44.8	32.4	9	13.1	301	312	1	3258951177013
E117702	22	47.3	33.4	9.5	13.7	318	347	1	3258951177020
E117703	23	47.3	33.4	9.5	13.7	318	349	1	3258951177037
E117704	24	51.6	35.4	10.1	14.9	338	436	1	3258951177044
E117705	26	54.5	37	10.4	15.7	355	527	1	3258951177051
E117706	27	55.6	40.4	11.4	17	375	576	1	3258951177068
E117707	28	55.6	40.4	11.4	17	375	591	1	3258951177075
E117708	29	58.6	42.3	12.4	18.2	414	727	1	3258951177082
E117709	30	58.6	42.3	12.4	18.2	414	720	1	3258951177099
E117710	32	65.5	46.8	13.4	19	435	869	1	3258951177105
E117711	33	70.2	49.7	13.4	17.5	470	1092	1	3258951177112
E117712	34	70.2	49.7	13.4	17.5	470	1079	1	3258951177129
E117713	35	70.2	49.7	13.4	17	470	1150	1	3258951177136
E117714	36	75.2	55.5	14.3	18.2	510	1303	1	3258951177143
E117715	38	75.2	55.5	14.3	18.2	510	1255	1	3258951177150
E117716	41	82	59.6	15	18	550	1567	1	3258951177167
E117717	42	82	59.6	15	18	550	1662	1	3258951177174
E117718	46	85	63.6	17.2	19	612	1763	1	3258951177181
E117719	50	95	72	19.3	22.2	650	2600	1	3258951177198

JOGO DE 12 CHAVES MISTAS LONGAS - MM

- Apresentadas em suporte de arrumação plástico.

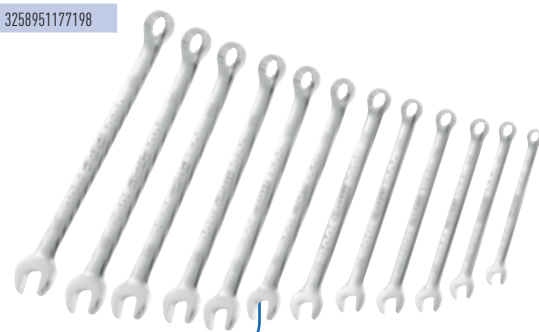

	Conteúdo	Qtd	Peso g	☒	EAN
E110303	8-9-10-11-12-13-14-15-16-17-18-19 mm.	12	1690	1	3258951103036



CHAVES MISTAS LUNETAS DESVIADA - MM

- ISO 691 - ISO 1711-1 - ISO 3318 - ISO 7738 - DIN 3113
- Cabeça poligonal 12 faces inclinação prolongada a 10°.
- Chave de boca com ângulo de 15° em relação ao eixo do cabo (ângulo de inclinação de 30°).
- Perfil do olhal que maximiza a superfície de contacto com a porca para uma longevidade acrescida.
- Forjadas a partir de aço de cromo-vanádio.
- Acabamento: cromado, pólido.

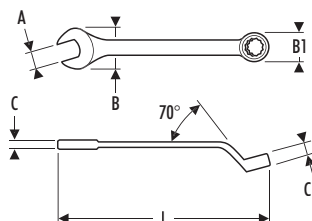
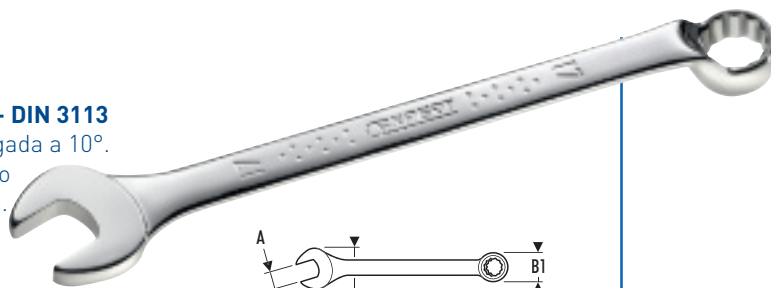

	A mm	B mm	B1 mm	C mm	C1 mm	L mm	Peso g	📦	EAN
E117720	6	16.3	10.4	3.7	5.2	125	17	1	3258951177204
E117721	7	18.2	11.8	3.7	5.7	135	21	1	3258951177211
E117722	8	20.3	13.4	4	6.3	145	32	1	3258951177228
E117723	9	22.2	14.4	4	7.3	155	41	1	3258951177235
E117724	10	23.8	16.2	4	7.3	165	44	1	3258951177242
E117725	11	25.7	17.2	4	8.1	172	56	1	3258951177259
E117726	12	27.6	18.7	4	8	180	67	1	3258951177266
E117727	13	28.8	20.3	5.9	9.6	195	77	1	3258951177273
E117728	14	31.7	21.5	5.9	9	210	89	1	3258951177280
E117729	15	34	22.8	6.4	10	215	107	1	3258951177297
E117730	16	36	24.2	6.8	10.9	230	132	1	3258951177303
E117731	17	38.6	26.1	7.1	11.6	240	150	1	3258951177310
E117732	18	39	27.2	7.4	12.2	255	167	1	3258951177327
E117733	19	42.1	28.8	7.8	12.5	265	191	1	3258951177334
E117734	21	45.3	31.7	8.4	12.8	280	240	1	3258951177341
E117735	22	46.1	33	8.6	13.1	300	276	1	3258951177358
E117736	23	51.4	35	9	14	320	347	1	3258951177365
E117737	24	51.4	35	9	14	320	337	1	3258951177372
E117738	26	54.5	38	10.4	15.3	348	448	1	3258951177389
E117739	27	57.8	41	10.8	16	370	569	1	3258951177396
E117740	28	57.8	41	10.8	16	370	553	1	3258951177402
E117741	29	62.5	43.7	11.4	16.5	390	664	1	3258951177419
E117742	30	62.5	43.7	11.4	16.5	390	651	1	3258951177426
E117743	32	67	46.7	12	17.5	412	813	1	3258951177433

JOGO DE 9 CHAVES MISTAS - MM

- Fornecido em caixa de cartão.



	Conteúdo	Peso g	📦	EAN
E117744	8-9-10-11-13-14-15-17-19 mm	840	1	3258951177440





CHAVES MISTAS DE ROQUETE

CHAVES MISTAS DE ROQUETE - MM

- ISO 691 - ISO 1711-1
- Ângulo de retoma de 5°.
- Cabeça poligonal de roquete 12 faces inclinada a 15°.
- Mudança de sentido por inversor encastrado e protegido.
- Chave de boca com ângulo de 15° em relação ao eixo do cabo (ângulo de inclinação de 30°).
- Perfil da luneta que maximiza a superfície de contacto com a porca para uma longevidade acrescida.
- Forjadas a partir de aço de cromo-vanádio.
- Acabamento: cromado, pólido.

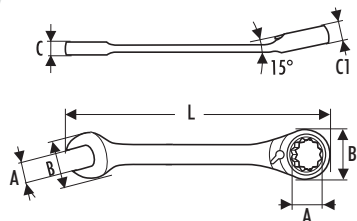
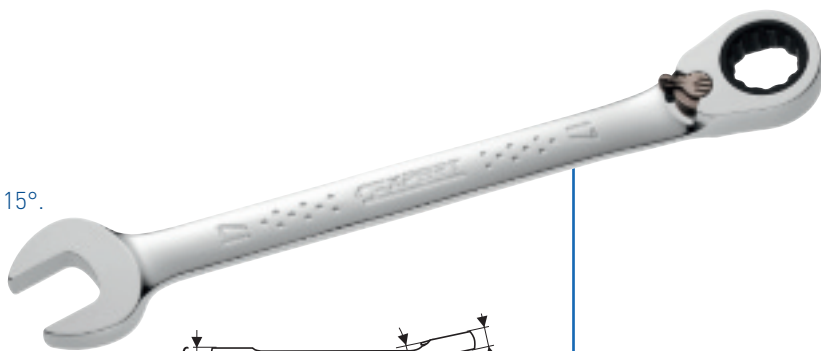

	A mm	B mm	B1 mm	C mm	C1 mm	L mm	Peso g	☒	EAN
E117377	6	16.3	17.7	5	7.7	124	28	1	3258951173770
E117378	7	16.3	17.7	5	7.7	124	28	1	3258951173787
E113301	8	18.5	17.7	5	7.7	135	32	1	3258951133019
E113302	9	20.5	19	5.3	7.7	142	40	1	3258951133026
E113303	10	22.5	21.2	5.8	8	158	56	1	3258951133033
E113300	11	25	22.6	5.9	8	167	68	1	3258951133002
E113304	12	26.9	23.8	6.1	8	173	78	1	3258951133040
E113305	13	29	25.9	6.6	8.9	179	96	1	3258951133057
E113306	14	31.5	27.7	7.5	9	189	116	1	3258951133064
E113307	15	34	29.2	7.9	9.4	199	136	1	3258951133071
E113308	16	35	31.8	7.9	9.9	215	160	1	3258951133088
E113309	17	38	34.1	8	10.6	232	182	1	3258951133095
E113310	18	40.1	34	8.5	11	238	200	1	3258951133101
E113311	19	42	35.1	8.9	11.2	247	248	1	3258951133118
E117370	21	45.3	41.5	10.3	13	285	540	1	3258951173701
E117371	22	45.3	41.5	10.3	13	285	540	1	3258951173718
E117372	24	52	47	10.8	14.5	325	710	1	3258951173725
E117373	27	58.6	52	12.5	15	359	750	1	3258951173732
E117374	30	64.5	59.5	13	17	425	970	1	3258951173749
E113460	32	64.5	59.5	13	17	425	970	1	3258951134603

JOGO DE CHAVES MISTAS DE ROQUETE - MM



	Conteúdo	Recipiente	Qtd	Peso g	☒	EAN
E111107	8-10-12-13-14-17-19 mm.	Suporte plástico	7	990	1	3258951111079
E111106	8-9-10-11-12-13-14-15-16-17-18-19 mm.	Suporte plástico	12	1670	1	3258951111062



CHAVES MISTAS DE ROQUETE RÁPIDAS - MM

- ISO 691 - ISO 1711-1
- Ângulo de retoma de 5°.
- Cabeça poligonal 12 faces direita.
- Mudança de sentido por inversão da chave.
- Chave de bocas com efeito de roquete orientada a 15°.
- Perfil da luneta que maximiza a superfície de contacto com a porca para uma longevidade acrescida.
- Forjadas a partir de aço de cromo-vanádio.
- Acabamento: cromado, pólido.

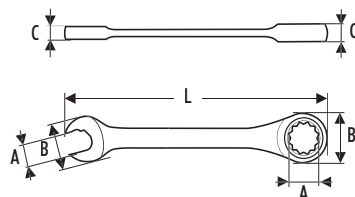

	A mm	B mm	B1 mm	C mm	C1 mm	L mm	Peso g	☒	EAN
E110924	8	18	17.5	5	7	136	30	1	3258951109243
E110925	9	20	19.3	5.4	7.6	143	45	1	3258951109250
E110926	10	22	21	5.8	7.7	160	55	1	3258951109267
E110927	11	24.5	22.7	6.1	8	168	65	1	3258951109274
E110928	12	26.5	24	6.4	8	174	75	1	3258951109281
E110929	13	27.6	26	6.7	9	180	105	1	3258951109298
E110930	14	31.4	27.7	7.4	9.4	193	115	1	3258951109304
E110931	15	33.4	29	7.7	10	200	140	1	3258951109311
E110932	16	34.6	30.7	8.1	10.6	216	165	1	3258951109328
E110933	17	38.4	33	8	10.9	233	185	1	3258951109335
E110934	18	39.9	33	9	11.2	239	205	1	3258951109342
E110935	19	41.5	34	9.5	11.5	250	225	1	3258951109359

JOGO DE 12 CHAVES MISTAS DE ROQUETE RÁPIDAS - MM

- Apresentadas em suporte de arrumação plástico.



	Conteúdo	Qtd	Peso g	☒	EAN
E111101	8-9-10-11-12-13-14-15-16-17-18-19 mm.	12	1590	1	3258951111017





CHAVES MISTAS DE ROQUETE

CHAVES MISTAS DE ROQUETE ARTICULADAS - MM

- ISO 691 - ISO 1711-1
- Ângulo de retoma de 5°.
- Cabeça poligonal 12 faces articulada a 180°.
- Mudança de sentido por inversão da chave.
- Cabeça de forquilha orientada a 15° em relação ao eixo do cabo (ângulo de curvatura 30°).
- Perfil da luneta que maximiza a superfície de contacto com a porca para uma longevidade acrescida.
- Forjadas a partir de aço de cromo-vanádio.
- Acabamento: cromado, pólido

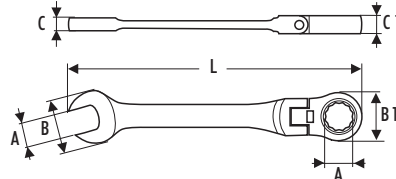

	A mm	B mm	B1 mm	C mm	C1 mm	L mm	Peso g	☒	EAN
E110901	8	17	17.5	5.5	7	136	40	1	3258951109014
E110902	9	19.2	19.3	5.8	7.6	143	50	1	3258951109021
E110903	10	21.3	21	6.1	7.7	160	65	1	3258951109038
E110904	11	23.7	22.7	6.4	8	168	75	1	3258951109045
E110905	12	25.8	24	6.7	8	174	90	1	3258951109052
E110906	13	26.8	26	7	9	180	110	1	3258951109069
E110907	14	30.4	27.7	7.3	9.4	193	130	1	3258951109076
E110908	15	32.1	29.1	7.7	10	200	140	1	3258951109083
E110909	16	33	30.7	8	10.6	216	180	1	3258951109090
E110910	17	37	32.6	8	10.9	233	205	1	3258951109106
E110911	18	38	33	8.6	11.2	239	230	1	3258951109113
E110912	19	40	34	9	11.5	250	270	1	3258951109120

JOGO DE CHAVES MISTAS DE ROQUETE ARTICULADAS - MM



	Conteúdo	Recipiente	Qtd	Peso g	☒	EAN
E111108	8-10-12-13-14-17-19 mm.	Suporte plástico	7	990	1	3258951111086
E111102	8-9-10-11-12-13-14-15-16-17-18-19 mm.	Suporte plástico	12	1620	1	3258951111024



CHAVES POLIGONAIS DE ROQUETE - MM

- ISO 691 - ISO 1711-1
- Ângulo de retoma de 5°.
- Cabeça poligonal 12 faces direita.
- Mudança de sentido por inversão da chave.
- Perfil da luneta que maximiza a superfície de contacto com a.
- Forjadas a partir de aço de cromo-vanádio.
- Acabamento: cromado, pólido.

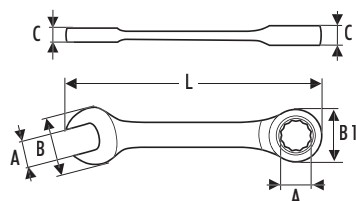

	A mm	B mm	B1 mm	C mm	C1 mm	L mm	Peso g	📦	EAN
E110914	10	21.3	21	5.5	7.7	96	40	1	3258951109144
E110916	12	25.4	24	6.1	8	104	55	1	3258951109168
E110917	13	26.8	26	6.3	9	108	65	1	3258951109175
E110918	14	29.8	27.7	6.7	9.4	114	80	1	3258951109182
E110919	15	31.6	29.1	7.1	10	118	100	1	3258951109199
E110921	17	36	32.6	7.8	10.9	128	125	1	3258951109212
E110923	19	40	34	8.5	11.5	138	155	1	3258951109236

JOGO DE 7 CHAVES MISTAS DE ROQUETE CURTAS - MM

- Rack de plástico.



	Conteúdo	Qtd	Peso g	📦	EAN
E111104	10-12-13-14-15-17-19 mm.	7	670	1	3258951111048





CHAVES DE LUNETA COM ROQUETE

JOGO DE 5 CHAVES POLIGONAIS DE ROQUETE - MM

→ Apresentadas em suporte de arrumação plástico.



E111103	Conteúdo	Qtd	Peso g		EAN
	8x10-10x11-12x13-14x15-17x19 mm.	5	730	1	3258951111031

CHAVES DE ROQUETE 4 EM 1

CHAVES DE ROQUETE "4 EM 1" - MM

- 4 dimensões por chaves.
- Cabeça poligonal 12 faces.
- Mudança do sentido por inversor encastrado e protegido.
- Acabamento: cromado, polido.

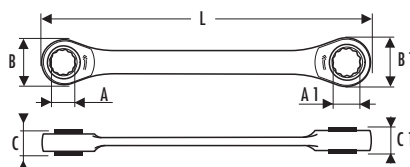

	A mm	A1 mm	B mm	B1 mm	C mm	C1 mm	L mm	Peso g		EAN
E110943	8x10	12x13	21,5	26,5	8,9	9,8	160	100	1	3258951109434
E110944	9x11	14x15	23,1	29,7	8,9	10,4	180	130	1	3258951109441
E110945	16x17	18x19	34,5	35,6	11,7	12,2	230	265	1	3258951109458



JOGO DE 3 CHAVES DE ROQUETE "4 EM 1" - MM

→ Fornecido em blister.



E111115	Conteúdo	Qty	Peso g	☒	EAN
	8x10-12x13 - 9x11-14x15 - 16x17-18x19	3	540	1	3258951111154

MÓDULOS DE CHAVES DE ROQUETE

MÓDULO DE 7 CHAVES MISTAS DE ROQUETE E 1 CHAVE INGLESÁ

- Tabuleiro termoformado.
- Concebidas para serem inseridas nas gavetas de um carro.
- Tabuleiro vazio: E010509.



E111100	Conteúdo	Qty	Peso g	☒	EAN
	8-10-12-13-14-17-19 mm.- 250 mm.	8	1575	1	3258951111000

MÓDULO DE 12 CHAVES MISTAS DE ROQUETE

- Tabuleiro termoformado.
- Concebidas para serem inseridas nas gavetas de um carro.
- Tabuleiro vazio: E195064.



E194938	Conteúdo	Qty	Peso g	☒	EAN
	8-9-10-11-12-13-14-15-16-17-18-19 mm.	12	1592	1	3258951949382





CHAVES DE BOCAS

CHAVES DE BOCAS - MM

→ ISO 691 - ISO 1711-1 - ISO 3318 - ISO 10102 - DIN 3110

→ Chave de boca com ângulo de 15° em relação ao eixo do cabo (ângulo de inclinação de 30°).

→ Forjadas em aço de cromo-vanádio.

→ Acabamento: cromado, pólido.

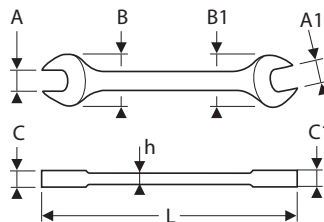
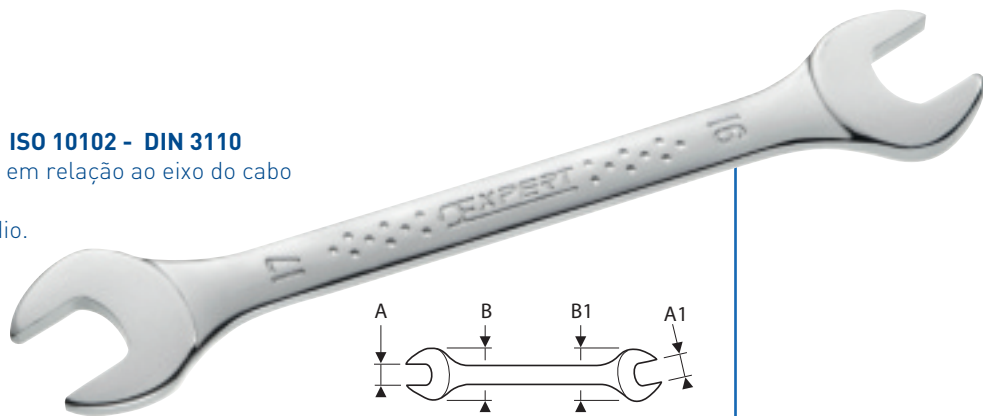

	A mm	A1 mm	B mm	B1 mm	C mm	C1 mm	L mm	Peso g		EAN
E113262	4	5	12.5	14.5	3.2	3.2	112	15	1	3258951132623
E113250	6	7	16	18	3.3	3.3	122	20	1	3258951132500
E113251	8	9	20	22	3.6	3.6	140	32	1	3258951132517
E113265	8	10	20	22	3.6	3.6	140	32	1	3258951132654
E113252	10	11	23.4	25.4	4	4	156	47	1	3258951132524
E113267	10	13	25.8	28.4	5	5	172	62	1	3258951132678
E113268	11	13	27.2	28.4	5	5	172	62	1	3258951132685
E113253	12	13	27.2	28.4	5	5	172	63	1	3258951132531
E113272	13	17	31.4	33.9	5.6	5.6	188	88	1	3258951132722
E113254	14	15	31.4	33.9	5.6	5.6	188	92	1	3258951132548
E113255	16	17	35.9	38	6.1	6.1	204	118	1	3258951132555
E113275	17	19	38.4	41.9	6.5	6.5	220	158	1	3258951132753
E113256	18	19	38.4	41.9	6.5	6.5	220	146	1	3258951132562
E113257	20	22	42	45.9	7.2	7.2	234	200	1	3258951132579
E113258	21	23	45.2	48.4	7.5	7.5	247	220	1	3258951132586
E113279	22	24	45.2	48.4	7.5	7.5	247	234	1	3258951132791
E111201	24	26	50.4	55.9	8	8	266	318	1	3258951112014
E113259	24	27	50.4	55.9	8	8	266	375	1	3258951132593
E113260	25	28	53.4	61.9	8.4	8.4	285	377	1	3258951132609
E113261	26	28	53.4	61.9	8.4	8.4	285	456	1	3258951132616
E113281	27	29	58.3	62.7	9.1	9.1	302	456	1	3258951132814
E113282	27	30	58.3	62.7	9.1	9.1	302	481	1	3258951132821
E113909	30	32	59.9	64	9.1	9.1	302	600	1	3258951139097
E113285	33	35	64	78	10	10	319	612	1	3258951132852
E113287	34	36	64	78	10	10	319	918	1	3258951132876
E113286	36	41	74.3	85.4	12.2	12.2	380	918	1	3258951132869
E113288	38	42	74.3	85.4	12.2	12.2	380	918	1	3258951132890
E111202	41	46	85	94	14.7	14.7	415	1450	1	3258951112021
E111203	46	50	94	103	15.7	15.7	465	1767	1	3258951112038

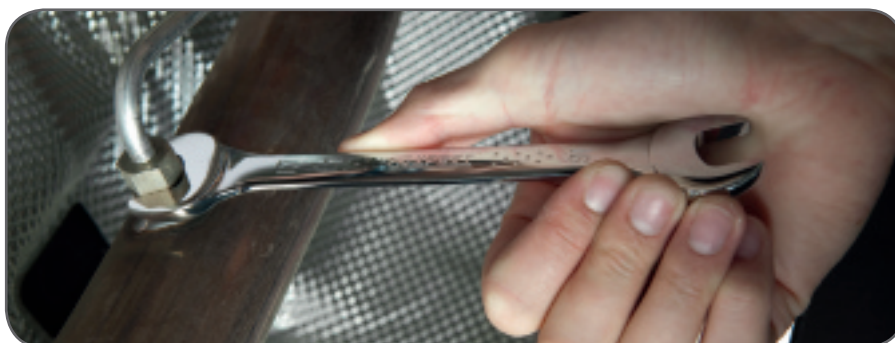



JOGOS DE CHAVES DE BOCAS - MM



	Conteúdo	Recipiente	Qtd	Peso g	📦	EAN
E111406	4x5-6x7-8x9-10x11-12x13-14x15-16x17-18x19 mm.	Suporte plástico	8	720	1	3258951114063
E117381	6x7-8x9-10x11-12x13-14x15-16x17-18x19-21x23-22x24-26x28-27x29-30x32 mm.	Caixa papelão	12	2350	1	3258951173817
E111222	6x7-8x9-10x11-12x13-14x15-16x17-18x19-21x23-22x24-26x28-27x29-30x32 mm.	Estojo	12	2350	1	3258951112229
E117382	4x5-6x7-8x9-10x11-12x13-14x15-16x17-18x19-21x23-22x24-26x28-27x29-30x32-33x35-36x41-38x42 mm.	Caixa papelão	16	4730	1	3258951173824

MÓDULO DE 11 CHAVES DE BOCAS

- Tabuleiro termoformado.
- Concebidas para serem inseridas nas gavetas de um carro.
- Tabuleiro vazio: E111221.



	Conteúdo	Qtd	Peso g	📦	EAN
E111220	6x7-8x9-10x11-12x13-14x15-16x17-18x19-21x23-22x24-27x29-30x32 mm.	11	2345	1	3258951112205





CHAVES DE BOCAS DIN

CHAVES DE BOCAS DIN

→ DIN 894 - ISO 272 - ISO 1711-1 - ISO 691 - ISO 3318

→ Boca orientada a 15° em relação ao eixo do cabo.

→ [ângulo de retoma 30°]

→ Forjadas a partir de liga de aço de alta qualidade.

→ Acabamento: fosfato preto.

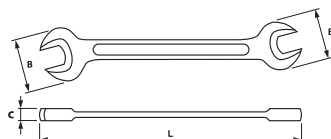

	A mm	A1 mm	B mm	B1 mm	C mm	L mm	Peso g		EAN
E114001	5.5	7	13	15	3	93	12	1	3258951140017
E114002	6	7	13	15	3	93	12	1	3258951140024
E114004	7	8	15	17	3.4	101	16	1	3258951140048
E114005	8	9	17	19	3.4	101	20	1	3258951140055
E114006	8	10	17	21	3.8	111	22	1	3258951140062
E114007	9	10	19	21	3.8	111	25	1	3258951140079
E114008	10	11	21	24	4.7	120	32	1	3258951140086
E114009	10	12	21	25	4.7	120	35	1	3258951140093
E114012	12	13	25	27	5.2	130	45	1	3258951140123
E114015	13	16	27	32.5	5.5	148	62	1	3258951140154
E114016	13	17	27	34.5	6	155	74	1	3258951140161
E114017	14	15	28.5	30.5	5.5	150	60	1	3258951140178
E114018	14	17	28.5	34.5	6	162	72	1	3258951140185
E114019	16	18	32.5	33.5	6.2	162	86	1	3258951140192
E114020	17	19	34.5	38.5	6.2	172	75	1	3258951140208
E114021	18	21	36.5	42	6.5	181	118	1	3258951140215
E114022	19	22	38.5	44	6.5	184	125	1	3258951140222
E114023	19	24	38.5	48	7.5	201	153	1	3258951140239
E114024	22	24	44	48	7.5	212	168	1	3258951140246
E114025	24	27	48	53	8.5	236	255	1	3258951140253
E114026	24	30	48	60	9.2	276	298	1	3258951140260
E114027	27	30	53	60	9.2	275	320	1	3258951140277
E114028	30	32	60	64	10.2	275	372	1	3258951140284
E114029	30	34	60	68	10.6	280	390	1	3258951140291
E114030	32	36	64	71	11.2	297	530	1	3258951140307
E114031	36	41	71	81	12.5	335	619	1	3258951140314
E114032	41	46	81	92	12.5	374	908	1	3258951140321
E114033	46	50	92	100	13	414	1130	1	3258951140338
E114034	55	60	110	120	14.4	480	1885	1	3258951140345



JOGO DE CHAVES DE BOCAS DIN - MM



E114040	Conteúdo	Recipiente	Qtd	Peso g	📦	EAN
	5,5x7-8x9-10x11-12x13-13x17-14x15-16x18-17x19-19x22-24x27-24x30-30x32 mm	Estojo	12	1750	1	3258951140406

CHAVES DE LUNETA

CHAVES DE LUNETA - MM

- ISO 691 - ISO 1711-1 - ISO 3318 - ISO 10104 - DIN 838
- Cabeça poligonal 12 faces contra-articuladas a 70° para proporcionar uma melhor acessibilidade às porcas encastradas.
- Perfil da luneta que maximiza a superfície de contacto com a porca para uma longevidade acrescida.
- Forjadas em aço crómio-vanádio.
- Acabamento: cromado, póldido.



	A mm	A1 mm	B mm	B1 mm	C mm	C1 mm	L mm	Peso g	📦	EAN
E113321	6	7	10.8	12.5	4	5.6	170	45	1	3258951133217
E113322	8	9	13.4	15.3	6	6.8	182	70	1	3258951133224
E111501	8	10	13.4	15.5	6	7.4	190	79	1	3258951115015
E113323	10	11	16	17.8	7.4	7.9	206	90	1	3258951133231
E113324	12	13	18.8	20.2	8.4	8.9	213	126	1	3258951133248
E113364	13	17	19	25.2	9	11	245	170	1	3258951133644
E113325	14	15	20.8	22.5	9.4	9.9	228	155	1	3258951133255
E113326	16	17	24.2	25.7	10.4	10.9	246	193	1	3258951133262
E113366	17	19	27.6	28.7	11.4	11.9	265	250	1	3258951133668
E111500	18	19	27.6	28.7	11.4	11.9	265	241	1	3258951115008
E111502	19	22	29.7	32.5	12.4	12.9	288	314	1	3258951115022
E113328	20	22	29.7	32.5	12.4	12.9	288	315	1	3258951133286
E113730	21	23	31	33	12.3	13.3	310	352	1	3258951137307
E113329	22	24	31	33	12.3	13.3	310	344	1	3258951133293
E111503	24	27	34	39	13.7	14.3	330	475	1	3258951115039
E113367	25	28	36.6	40.5	14.2	14.7	348	548	1	3258951133675
E113368	27	29	42	45.2	15	16	372	662	1	3258951133682
E113369	27	30	42	45.2	15	16	372	662	1	3258951133699
E117376	30	32	42.2	45.5	15	16	372	635	1	3258951173763





CHAVES DE LUNETA

JOGOS DE CHAVES POLIGONAIS CURVAS - MM



	Conteúdo	Recipiente	Qtd	Peso g		EAN
E111709	20x22-21x23-24x27-27x30-30x32 mm.	Caixa papelão	5	2575	1	3258951117095
E111708	8x9-10x11-12x13-14x15-16x17-18x19 mm.	Suporte plástico	6	980	1	3258951117088
E111714	6x7-8x9-10x11-12x13-16x17-18x19-24x27-30x32 mm.	Estojo	8	1700	1	3258951117149

MÓDULO DE 8 CHAVES LUNETA

- Tabuleiro termoformado.
- Concebidas para serem inseridas nas gavetas de um carro.
- Tabuleiro vazio: E111711.



	Conteúdo	Qtd	Peso g		EAN
E111710	6x7-8x9-10x11-12x13-14x15-16x17-18x19-22x24 mm.	8	1576	1	3258951117101



CHAVES TIPO CACHIMBO

CHAVES TIPO CACHIMBO ABERTAS 12 FACES X SEXTAVADAS

- ISO 691 - ISO 2236
- A curva específica procura proporcionar uma grande resistência à torção.
- A abertura permite a passagem de uma haste roscada e a utilização de um cabo para aumentar o binário de aperto.
- A puncionagem profunda nas cabeças permite o aperto mesmo em caso de superação da haste roscada.
- Forjadas em aço de crómio-vanádio.
- Acabamento: cromado, póldo.

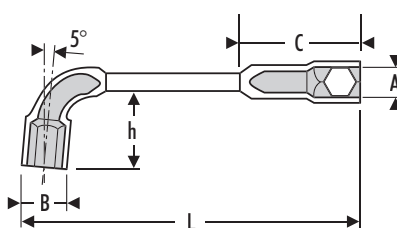

	A mm	B mm	C mm	L mm	Peso g	☒	EAN
E113458	6	10	23	102	30	1	3258951134580
E113459	7	11	24	106	40	1	3258951134597
E113370	8	12.5	27	114	55	1	3258951133705
E113371	9	13.5	28	122	75	1	3258951133712
E113372	10	15	30	129	90	1	3258951133729
E113373	11	16.5	32	136	110	1	3258951133736
E113374	12	18	38	144	150	1	3258951133743
E113375	13	19.5	40	152	165	1	3258951133750
E113376	14	21	42	160	200	1	3258951133767
E113377	15	22.5	44	169	220	1	3258951133774
E113378	16	24	49	178	270	1	3258951133781
E113379	17	25.5	51	187	310	1	3258951133798
E113380	18	26.5	53	195	330	1	3258951133804
E113381	19	28.5	54	204	410	1	3258951133811
E113382	20	29.5	56	212	465	1	3258951133828
E113383	21	30.5	58	221	490	1	3258951133835
E113384	22	32	60	230	525	1	3258951133842
E113385	23	33.5	67	240	640	1	3258951133859
E113386	24	34.5	70	250	640	1	3258951133866
E113388	27	38	77	280	960	1	3258951133880
E113389	30	42	87	310	1250	1	3258951133897
E113390	32	44.5	92	330	1425	1	3258951133903





CHAVES TIPO CACHIMBO

JOGOS DE CHAVES DE CACHIMBO ABERTAS



	Pans	Conteúdo	Recipiente	Qtd	Peso g		EAN
E117387	6 x 12	8-10-11-12-13-14-16-17-18-19 mm.	Caixa papelão	10	2230	1	3258951173879
E117386	6 x 12	8-9-10-11-12-13-14-15-16-17-18-19-21-22-23-24 mm.	Caixa papelão	16	4890	1	3258951173862
E112201	6 x 12	6-7-8-9-10-11-12-13-14-15-16-17-18-19-20-21-22-23-24-27-30-32 mm.	Caixa papelão	22	9210	1	325895112013

CHAVES DE TUBOS DOBRADA

CHAVES TUBULARES SEXTAVADAS X SEXTAVADAS

- ISO 691 - ISO 2236
- Permite trabalhar em hastes roscadas longas.
- Orifício de passagem que permite a utilização de um cabo.
- Acabamento: cromado, pólido.



	A mm	B mm	H mm	L mm	Peso g		EAN
E113500	5	8	23.5	95	25	1	3258951135006
E113501	5.5	9	25	95	25	1	3258951135013
E113502	6	9.9	26.5	100	30	1	3258951135020
E113503	7	11.1	28.5	100	30	1	3258951135037
E113504	8	12.7	31.5	109	50	1	3258951135044
E113505	9	13.9	33	109	50	1	3258951135051
E113506	10	15.5	36.5	118	77	1	3258951135068
E113507	11	16.7	36.5	118	87	1	3258951135075
E113508	12	18	43	127	117	1	3258951135082
E113509	13	19.5	43	127	118	1	3258951135099
E113510	14	21.2	49	136	156	1	3258951135105
E113512	15	22.3	49	136	157	1	3258951135129
E113513	16	23.4	55	145	190	1	3258951135136
E113514	17	24.5	55	145	191	1	3258951135143
E113515	18	25.8	61	154	226	1	3258951135150
E113516	19	27	61	154	227	1	3258951135167
E113517	21	30.3	67.5	163	317	1	3258951135174
E113518	22	31.4	68	172	353	1	3258951135181
E113519	23	32.5	72.5	172	360	1	3258951135198
E113520	24	33	74.5	180	420	1	3258951135204

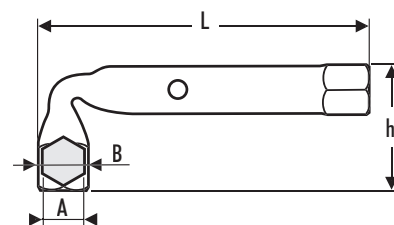



CHAVES TUBULARES DIREITAS SEXTAVADAS

- UNI 6746 - ISO 2236 - DIN 896
- Orifício de passagem que permite a utilização de uma barra.
- Corpo em aço com crómio-molibdénio.
- Acabamento: cromado polido.



	A mm	d mm	L mm	Peso g	☒	EAN
E112801	6x7	5.5	100	25	5	3258951128015
E112802	8x9	5.5	108	45	5	3258951128022
E112803	8x10	5.5	90	50	5	3258951128039
E112804	9x10	5.5	90	50	5	3258951128046
E112805	10x11	6.5	116	60	5	3258951128053
E112806	11x12	6.5	100	70	5	3258951128060
E112807	12x13	6.5	124	90	5	3258951128077
E112808	13x17	8.5	100	110	5	3258951128084
E112809	14x15	8	132	125	5	3258951128091
E112810	16x17	8	140	150	5	3258951128107
E112811	18x19	8	158	175	5	3258951128114
E112812	20x22	10	156	245	5	3258951128121
E112813	21x23	10	163	275	3	3258951128138
E112814	24x26	11	173	325	3	3258951128145
E112815	25x28	12.5	182	445	3	3258951128152
E112816	27x29	12.5	191	475	3	3258951128169
E112817	30x32	13.5	200	590	3	3258951128176

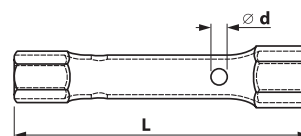

CHAVES TUBULARES HEXAGONAIS SIMPLES

- Orifício de passagem que permite a utilização de uma barra.



	A mm	d mm	d1 mm	L mm	Peso g	☒	EAN
E112818	8	12	4.5	70	20	1	3258951128183
E112819	9	13.2	4.5	70	30	1	3258951128190
E112820	10	14.5	5.5	80	30	1	3258951128206
E112821	12	16.2	6.5	80	60	1	3258951128213
E112822	13	17.6	6.5	80	60	1	3258951128220
E112823	14	19.5	6.5	80	60	1	3258951128237
E112824	16	21.9	6.5	80	60	1	3258951128244
E112825	18	24.6	10.5	90	80	1	3258951128251
E112826	17	23.3	8.5	90	70	1	3258951128268
E112827	19	25.9	10.5	90	80	1	3258951128275
E112828	21	28.2	10.5	90	120	1	3258951128282
E112829	22	29.6	10.5	90	120	1	3258951128299
E112830	24	31.9	12.5	100	140	1	3258951128305
E112831	27	35.8	12.5	100	170	1	3258951128312
E112832	30	39.7	16.5	110	208	1	3258951128329

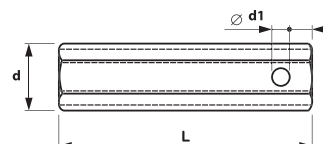



PASSADORES PARA CHAVES DE TUBOS

PASSADOR

→ ISO 286-2

→ Para controlar as chaves tubulares

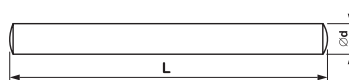

	d mm	L mm	Peso g	☒	EAN
E112901	6	125	30	1	3258951129012
E112902	8	160	60	1	3258951129029
E112903	10	220	140	1	3258951129036

CHAVES LUNETA ABERTA

CHAVE ABERTA SEXTAVADA

→ DIN 3118 - ISO 691

→ Cabeça poligonal com ângulo de 15°.

→ Cabeças inclinadas a 15° em relação ao eixo do cabo.

→ Perfil sextavado até à dimensão 12x14.

→ Forjadas a partir de aço de cromo-vanádio.

→ Acabamento: cromado, póldo.

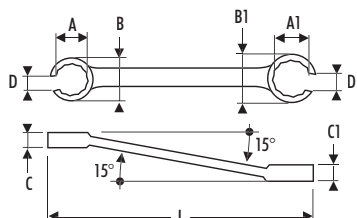

	A mm	A1 mm	B mm	B1 mm	C mm	C1 mm	d mm	d1 mm	L mm	Peso g	☒	EAN
E112301	7	9	17.8	19.3	6.5	7.5	6	6.5	139	41	1	3258951123010
E117388	8	10	17.8	19.3	6.5	7.5	6	7	139	41	1	3258951173886
E117391	11	13	22.8	25.3	6.5	7.5	6	7	174	82	1	3258951173916
E117392	12	14	22.8	25.3	8.5	10.5	9	11	174	77	1	3258951173923
E117394	17	19	31.2	33	12	13	14	15	213	182	1	3258951173947
E117395	19	22	33.4	38.4	13	14	15	17	228	229	1	3258951173954
E117368	24	27	42.4	46.4	16	17	18	20	255	412	1	3258951173688



JOGO DE 5 CHAVES ABERTAS SEXTAVADAS X SEXTAVADAS

→ Fornecidas em expositor plástico.



	Conteúdo	Qtd	Peso g	☒	EAN
E112501	7x9-8x10-11x13-12x14-17x19 mm.	5	470	1	3258951125014

CHAVES FRANCESAS

CHAVE CRESCENTE

- ISO 6787 - DIN 3117 - ASME B 107.8 M
- Cabeça inclinada a 15° que permite restituir o ângulo de deslocação a 30° por retorno.
- Corpo forjado em aço de cromo-vanádio.
- Apresentação: cromado, faces polidas.
- Diminuição da espessura das pontas para uma melhor acessibilidade.
- Design arredondado da pega para uma melhor ergonomia.
- Mordentes inteiramente temperados.

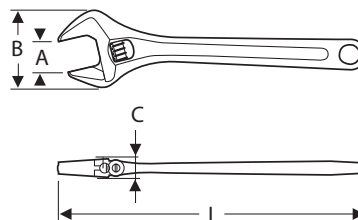

	A mm	B mm	C mm	L mm	Peso g	☒	EAN
E187366	20	46	10,8	6" - 150	130	1	3258951873663
E187368	24	57,4	13,5	8" - 200	240	1	3258951873687
E187470	29	69,8	16	10" - 250	440	1	3258951874707
E187472	34	82,3	19	12" - 300	700	1	3258951874721
E187473	44	104,3	25	15" - 375	1290	1	3258951874738
E117905	55	120	26	18" - 450	1950	1	3258951179055
E117906	62	132	31	24" - 600	3225	1	3258951179062





CHAVES FRANCESAS

CHAVES CRESCENTES BI-MATÉRIA

- ISO 6787 - DIN 3117 - ASME B 107.8 M
- Cabeça inclinada a 15° que permite restituir o ângulo de deslocação a 30° por retorno.
- Diminuição da espessura das pontas para uma melhor acessibilidade.
- Sentido de rotação do rolete: à direita.
- Pega plástica para mais conforto.
- Corpo forjado a partir de aço de cromo-vanádio.
- Acabamento: cromado, faces polidas.

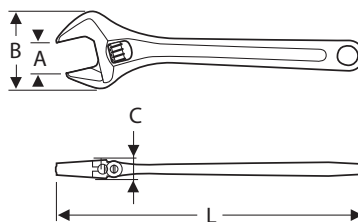

	A mm	B mm	C mm	L mm	Peso g		EAN
E112605	30	60.2	12.9	8" - 210	245	1	3258951126059
E112606	35	72.0	15.4	10" - 260	450	1	3258951126066
E112607	41	84.0	18.3	12" - 310	740	1	3258951126073

JOGO DE 3 CHAVES CRESCENTES BI-MATÉRIA

- ISO 6787 - DIN 3117 - ASME B 107.8 M
- Cabeça inclinada a 15° que permite restituir o ângulo de deslocação a 30° por retorno.
- Diminuição da espessura das pontas para uma melhor acessibilidade.
- Sentido de rotação do rolete: à direita.
- Pega plástica para mais conforto.
- Corpo forjado a partir de aço de cromo-vanádio.
- Acabamento: cromado, faces polidas.



	Qtd	Peso g		EAN
E112703	3	1435	1	3258951127032



CHAVES DE PINOS

CHAVE DE PINOS

- Capacidade 19 a 159 mm.
- Corpo forjado em aço de cromo-vanádio.
- Apresentação: cromado, brilhante.

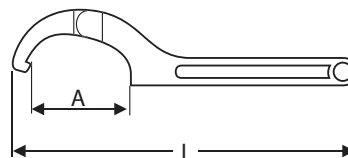

	A mm	L mm	Peso g	☐	EAN
E112601	19 - 51	165	130	1	3258951126011
E112602	32 - 76	216	225	1	3258951126028
E112603	51 - 121	267	455	1	3258951126035
E112604	114 - 159	308	490	1	3258951126042

CHAVES PARA ANDAIMES

CHAVES PARA ANDAIMES

- Montagem/desmontagem especial de andaimes.
- Mecanismo 32 dentes.
- Mudança de sentido por inversor encastrado e protegido.
- Mecanismo de dupla face proporciona dois tamanhos por chave:
 - E110961: 17 x 19 mm.
 - E110962: 21 x 22 mm.
- Acabamento: Zinco.

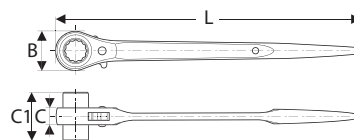

	B mm	C mm	C1 mm	L mm	Peso g	☐	EAN
E110961	40.7	17	50	309	430	1	3258951109618
E110962	40.7	17	50	309	714	1	3258951109625

CHAVE PARA ANDAIMES 19 MM

- ISO 691
- Montagem/desmontagem especial de andaimes.
- Cabeça retificada de modo a ser utilizada como um martelo.
- Pega perfurada para a utilização de uma cinta para os trabalhos em altura.
- Acabamento: fosfato preto.

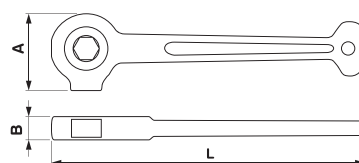

	A mm	B mm	L mm	Peso g	☐	EAN
E114301	65	28.5	270	780	1	3258951143018



ROQUETES E CHAVES DE CAIXA





Composições de chaves de caixa

P.50



Composições de chaves de caixa 1/4"

P.54



Composições de chaves de caixa 3/8"

P.66



Composições de chaves de caixa 1/2"

P.77



Composições de chaves de caixa 3/4"

P.95



Composições de chaves de caixa 1"

P.100





→ O SISTEMA DE **ARRUMAÇÃO EXPERT**: ESTOJOS COMPACTOS, RESISTENTES E MODULÁVEIS

→ **GAMA DE TAMANHOS**

6 tamanhos de estojos para responder a todas as necessidades com um máximo de compacidade.

→ **REVESTIMENTO**

O revestimento interior dos estojos é uma placa Plástico ou espuma consoante as necessidades.

→ **PEGA**

As 2 dimensões maiores incluem uma **pega integrada** para facilitar o transporte sem afectar a compacidade nem a modularidade.

→ **SISTEMA DE FECHO**

Duplo fecho integrado nos 4 modelos maiores, que garante um bloqueio resistente e eficaz.



C. 565 x P. 415 x A. 92 mm



C. 415 x P. 283 x A. 92 mm



→ ARMAZENAMENTO IDEAL NOS CARROS

→ ARRUMAÇÃO – MODULARIDADE

Cada estojo é **2 vezes mais pequeno** que o estojo de dimensão superior. A dimensão maior foi pensada para corresponder à dimensão de uma gaveta de um carro Expert.

→ ARRUMAÇÃO – ORGANIZAÇÃO

O armazenamento das caixas nas gavetas é, por isso, **fácil e otimizado**, quer seja para a arrumação de caixas fechadas ou para a utilização dos estojos como módulos na gaveta de um carro Expert..

→ ABERTURA

Na verdade, a **abertura** das caixas é feita a **100%**, o que permite posicioná-las completamente planas nas gavetas. As gavetas do carro podem assim ser organizadas com os módulos e/ou caixas fechadas ou abertas, uma vez que todos estes elementos de arrumação são compatíveis.



A DICA PRÁTICA

A união das 2 partes das caixas é feita através de uma dobradiça metálica estraível camoteável. Assim, é possível e fácil separar as caixas em 2 partes de modo a utilizá-las como módulo completamente independentes.



C. 275 x P. 186 x A. 80 mm



C. 186 x P. 138 x A. 54 mm



C. 137 x P. 94 x A. 31 mm



C. 92 x P. 64 x A. 31 mm





COMPOSIÇÕES DE CHAVES DE CAIXA

CAIXA DE CHAVES DE CAIXA, CHAVES E ACESSÓRIOS 1/4" - 1/2" - 101 PEÇAS

- Chaves de caixa 1/4" sextavadas: 4-4,5-5-5,5-6-7-8-9-10-11-12-13-14 mm.
- Chaves de caixa aparafusadoras sextavadas 1/4": 3-4-5-6 mm.
- Chaves de caixa aparafusadoras 1/4": Pozidriv® PZ1-PZ2 - Phillips® PH1-PH2.
- Chaves de caixa aparafusadoras Torx® 1/4": T8-T10-T15-T20-T25-T27-T30.
- Chaves de caixa sextavadas 1/2": 10-11-12-13-14-15-16-17-18-19-20-21-22-24-27-30-32 mm.
- Chaves de caixa longas sextavadas 1/2": 13-17-19 mm.
- Chaves de caixa aparafusadoras de fenda 1/4": 4-5,5-7 mm.
- Pontas de fenda 5/16": 8-12 mm.
- Pontas Phillips® 5/16": PH3-PH.
- Pontas Pozidriv® 5/16": PZ3-PZ.
- Pontas sextavadas 5/16": 12-14 mm.
- Pontas Torx® 5/16": T40-T45-T50-T55.
- Chaves macho no estojo: 1,5-2-2,5-3-4-5-6-7-8-9-10 mm.
- Chaves mistas: 7-8-10-11-12-13-14-15-16-17-18-19 mm.
- 1 roquete cabeça corpo longo com bloqueio 1/4".
- 1 chave de punho porta-bits de 1/4".
- 2 extensões 1/4": 55-100 mm.
- 1 cardan 1/4".
- 1 cabo T correção 1/4".
- 1 chave de punho porta acessórios com cabo bi-matéria.
- 1 roquete cabeça corpo longo com bloqueio 1/2".
- 1 cardan 1/2".
- 2 extensões 1/2": 130-250 mm.
- 1 cabo T correção 1/2".
- 2 chaves de caixa para velas 1/2": 16-21 mm.
- 1 adaptador 1/2" para ponteiras 5/16".
- Entregue em caixa compatível com gaveta de carro.

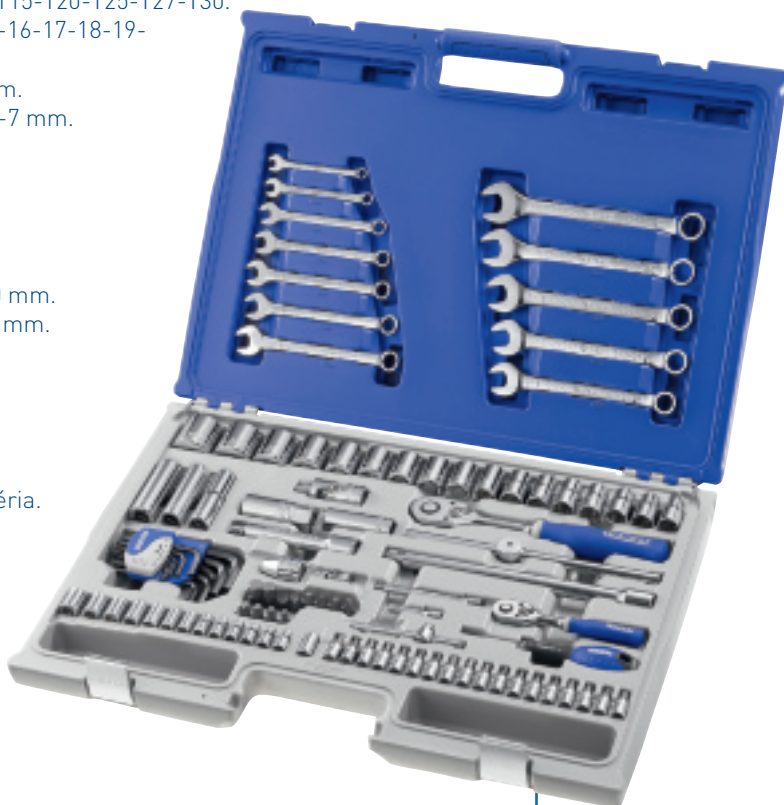

E032911	1/4" - 1/2"	Qde	Dimensões	Peso kg	☒	EAN
E032911	1/4" - 1/2"	101	L.565xP.415xH.92 mm	8	5	3258950315256

MÓDULO DE CHAVES DE CAIXA E ACESSÓRIOS - 1/4" - 3/8" MÉTRICAS - 62 PEÇAS

- 1 roquete parquímetro de bloqueio 1/4".
- 1 chave de caixa porta-pontas 1/4".
- 2 extensões 1/4" 55-100 mm.
- 13 chaves de caixa 1/4" 6 faces: 4-14 mm.
- 11 chaves de caixa Torx® 1/4": T6 - T40.
- 1 roquete parquímetro de bloqueio 3/8".
- 1 chave de caixa porta-pontas 3/8".
- 1 extensão 3/8" 125 mm.
- 14 chaves de caixa 3/8" 12 faces: 8-22 mm.
- 14 chaves de caixa longas 3/8" sextavadas : 8-22 mm.
- 3 chaves de caixa Torx® 3/8": T45-T50-T55.
- Tabuleiro vazio: E034854.

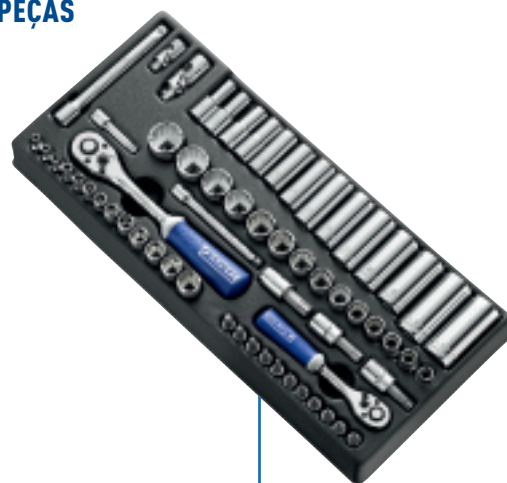

E034853	1/4" - 1/2"	Qde	Peso kg	☒	EAN
E034853	1/4" - 1/2"	62	3,1	1	3258950348537



JOGO DE CHAVES DE CAIXA E ACESSÓRIOS 1/4" - 1/2" - 98 PEÇAS

- Chaves de caixa 1/4" sextavadas: 4-5-5,5-6-7-8-9-10-11-12-13 mm.
- Chaves de caixa longas sextavadas 1/4": 6-8-10-11-12-13-14 mm.
- Pontas Torx® 1/4": T6-T8-T10.
- Chaves de caixa aparafusadoras de fenda 1/4": 4-7 mm.
- Chaves de caixa aparafusadoras Torx® 1/4": T8-T10-T15-T20-T25-T27-T30.
- Chaves de caixa aparafusadoras Pozidriv® 1/4": PZ1-PZ2.
- Chaves de caixa aparafusadoras Phillips® 1/4": PH1-PH2.
- 1 roquete cabeça corpo longo com bloqueio 1/4".
- 2 extensões 1/4": 55-100 mm.
- 1 cardan 1/4".
- 1 cabo T correção 1/4".
- 1 chave de punho porta acessórios com cabo bi-matéria.
- Chaves de caixa sextavadas 1/2": 10-11-12-13-14-15-16-17-18-19-20-21-22-24-27-30-32 mm.
- Chaves de caixa longas sextavadas 1/2": 14-15-17-19-22 mm.
- 2 chaves de caixa para velas 1/2": 16-21 mm.
- Chaves de caixa Torx® 1/2": E12-E14-E16-E18-E20-E24.
- 1 roquete cabeça corpo longo com bloqueio 1/2".
- 1 adaptador 3/8" - 1/2".
- 1 chave de caixa 1/2" porta-pontas 5/16".
- 1 cardan 1/2".
- 2 extensões 1/2": 130-250 mm.
- Pontas XZN 5/16": 6-8-10-12.
- Pontas de fenda 5/16": 8-12 mm.
- Pontas Torx® 5/16": T40-T45-T50-T55.
- Pontas sextavadas 5/16": 8-10-12-14 mm.
- Entregue em caixa compatível com gaveta de carro.



E034805	1/4" - 1/2"	Qde	Dimensões	Peso kg	1	EAN
		98	L.415xP.283xH.92	6,5		3258950348056

JOGO DE CHAVES DE CAIXA TORX® 1/4" - 3/8" - 1/2" - 13 PEÇAS

- Chaves de caixa Torx® 1/4": E4-E5-E6-E7-E8.
- Chaves de caixa Torx® 3/8": E10-E12-E14-E16.
- Chaves de caixa Torx® 1/2": E18-E20-E22-E24.
- Fornecido em expositor metálico.



E034801	1/4" - 3/8" - 1/2"	Qde	Peso g	10	EAN
		13	500		3258950348018





COMPOSIÇÕES DE CHAVES DE CAIXA

CAIXA DE CHAVES DE CAIXA SEXTAVADAS, TORX®, XZN - 38 PEÇAS

- Chaves de caixa 1/2" TORX: T40, T45, T50, T55, T60, T70, L140 mm
- Chave de caixa 1/2" Tamper TORX: TT30, L300 mm
- Chave de caixa 1/2" Tamper TORX: TT80, L100 mm
- Chave de caixa 1/2" HEX: 7, L230 mm
- Chaves de caixa 1/2" HEX: 10, 11, 13, L140 mm
- Chaves de caixa 1/2" HEX: 14, 17, 19, 22, 24, L50 mm
- Chave de caixa 1/2" HEX Ball: 5, L160 mm
- Chave de caixa 1/2" XZN: M9, L100 mm
- Chaves de caixa 1/2" XZN: M10, M12, M14, L140 mm
- Chave de caixa 1/2" XZN oca: M16, L55 mm
- Chave de caixa 1/2" XZN oca: M16, L100 mm
- Chave de caixa 1/2" XZN Impacto: M18, L75 mm
- Chaves de caixa 1/4" TS: 10, 15, 20, 25, 27, 30, 40, 45, 50, L37 mm
- Chaves de caixa 1/2" especiais: 7, 8, L240 mm
- Chave de caixa 1/2" especial: 9, L100 mm
- Chave de caixa 1/2" especial: 10, L140 mm



		Qde	Dimensões	Peso kg		EAN
E200513	1/4" - 1/2"	38	L.420xP.355xH.92mm	6,07	5	3258952005131

JOGO DE CHAVES DE CAIXA 1/4" - 3/8" - 9 PEÇAS

- Chaves de caixa aparafusadoras hexagonal 1/4": 3-4-5-6 mm.
- Chaves de caixa aparafusadoras hexagonais 3/8": 7-8-9-10-12 mm.
- Fornecido em expositor metálico.



		Qde	Peso g		EAN
E034802	1/4" - 3/8"	9	300	10	3258950348025

JOGO DE ADAPTADORES MAGNÉTICOS - 3 PEÇAS

- Utilização apenas com ferramentas manuais.
- Magnetizado.
- Entregue em expositor metálico.
- 3 adaptadores:
 - E041505: 1/4" a 3/8".
 - E041506: 3/8" a 1/2".
 - E041507: 1/2" a 3/4".

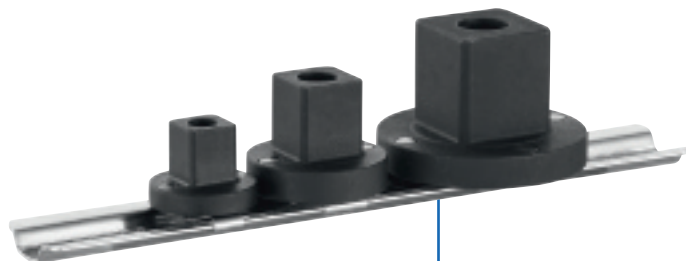

	Qde	Peso g		EAN
E041649	3	183	1	3258950416496



Modularidade

Tampa amovível

Punho ergonómico

Fechos

Robustas

• • •

• • •

• • •

• • •

• • •

• • •

• • •

• • •

• • •

• • •

CAIXA DE CHAVES DE CAIXA E ACESSÓRIOS 1/4" - 1/2" MÉTRICAS - 44 PEÇAS

- Chaves de caixa 1/4": 5,5-7-8-9-10-12-13 mm.
- 1 roquete parquímetro de bloqueio 1/4".
- 1 extensão 1/4": 55 mm.
- 1 chave de caixa 1/4" porta-pontas com anel de segurança padrão
- 1 roquete parquímetro de bloqueio 1/4".
- Chaves de caixa 1/2": 13-16-18-21-24-27-30-34 mm.
- Chaves de caixa sextavadas 1/2": 8-10-12-14 mm.
- 2 extensões 1/2": 130-250 mm.
- 1 chave de caixa para velas 1/2": 16 mm.
- 1 pega corrediça 1/2".
- Pontas (fendas, sextavadas, Pozidriv®, Torx®)
- 1 pega de chave de dupla matéria.



E034855	1/4" - 1/2"	Qde	Peso kg	✉	EAN
E034855	1/4" - 1/2"	44	5,2	1	3258950348551





COMPOSIÇÕES DE CHAVES DE CAIXA 1/4"

CAIXA DE CHAVES DE CAIXA E ACESSÓRIOS 1/4" - 73 PEÇAS

- Chaves de caixa 1/4" sextavadas: 4-4,5-5-5,5-6-7-8-9-10-11-12-13-14 mm.
- Chaves de caixa longas 1/4" sextavadas: 5-5,5-6-7-8-10-11-12-13 mm.
- Chaves de caixa 1/4" 12 faces: 1/2"-1/4"-11/32"-3/16"-3/8"-5/16"-7/16"-7/32"-9/16"-9/32".
- Chaves de caixa aparafusadoras de fenda 1/4": 4-5,5-7 mm.
- Chaves de caixa aparafusadoras Pozidriv® 1/4": PZ1-PZ2-PZ3.
- Chaves de caixa aparafusadoras Phillips® 1/4": PH1-PH2-PH3.
- Chaves de caixa aparafusadoras Torx® 1/4": T6-T7-T8-T9-T10-T15-T20-T25-T30-T40.
- Chaves de caixa Torx® 1/4": E4-E5-E6-E7-E8-E10.
- Chaves de caixa aparafusadoras sextavadas 1/4": 2-2,5-3-4-5-6-7-8 mm.
- 1 roquete cabeça corpo longo com bloqueio 1/4".
- 3 extensões 1/4": 55-100-150 mm.
- 1 chave de punho porta acessórios com cabo em bi-matéria.
- 1 cardan universal 1/4".
- 1 cabo T correção 1/4".
- 1 chave de caixa porta-pontas 1/4".
- Entregue em caixa compatível com gaveta de carro.



		Qde	Dimensões	Peso kg		EAN
E030707	1/4"	73	L.275xP.186xH.80 mm	2	5	3258950307077



CAIXA DE CHAVES DE CAIXA E ACESSÓRIOS 1/4" - 42 PEÇAS

- Chaves de caixa 1/4" sextavadas: 4-4,5-5-5,5-6-7-8-9-10-11-12-13-14 mm.
- Chaves de caixa aparafusadoras Pozidriv® 1/4": PZ1-PZ2-PZ3.
- Chaves de caixa aparafusadoras Phillips® 1/4": PH1-PH2-PH3.
- Chaves de caixa aparafusadoras sextavadas 1/4": 3-4-5-6-7-8 mm.
- Chaves de caixa aparafusadoras Torx® 1/4": T10-T15-T20-T25-T30-T40.
- Chaves de caixa aparafusadoras de fenda 1/4": 4-5,5-7 mm.
- 3 extensões 1/4": 55-100-150 mm.
- 1 cabo T correção 1/4".
- 1 chave de punho porta acessórios com cabo em bi-matéria.
- 1 cardan universal 1/4".
- 1 roquete cabeça corpo longo com bloqueio 1/4".
- 1 chave de punho porta-bits 1/4".
- Entregue em caixa compatível com gaveta de carro.



		Qde	Dimensões	Peso kg		EAN
E030702	1/4"	42	L.275xP.186xH.80 mm	1,5	10	3258950307022



CAIXA DE CHAVES DE CAIXA E ACESSÓRIOS 1/4" - 34 PEÇAS

- Chaves de caixa 1/4" sextavadas: 4-4,5-5-5,5-6-7-8-9-10-11-12-13-14 mm.
- Pontas de fenda: 4-5,5-6,5 mm.
- Pontas Pozidriv®: PZ1-PZ2-PZ3.
- Pontas Résistorx®: TT10-TT15-TT20-TT25-TT30-TT40.
- Pontas sextavadas: 4-5-6 mm.
- 1 adaptador pontas 1/4".
- 2 extensões 1/4": 55-100 mm.
- 1 cardan universal 1/4".
- 1 chave de punho porta acessórios com punho em bi-matéria.
- 1 roquete cabeça corpo longo com bloqueio 1/4".
- Entregue em caixa compatível com gaveta de carro.



E194672	1/4"	Qde	Dimensões	Peso kg	4	EAN
		34	L.186xP.138xH.54 mm	1		3258951946725

CAIXA DE CHAVES DE CAIXA E ACESSÓRIOS 1/4" - 19 PEÇAS

- Chaves de caixa 1/4" sextavadas: 4-4,5-5-5,5-6-7-8-9-10-11-12-13-14 mm.
- 1 roquete cabeça corpo longo com bloqueio 1/4".
- 2 extensões 1/4": 55-100 mm.
- 1 cardan 1/4".
- 1 adaptador 1/4 para ponteiros 1/4".
- 1 cabo T correção 1/4".
- Entregue em caixa compatível com gaveta de carro.



E030700	1/4"	Qde	Dimensões	Peso kg	10	EAN
		19	L.186xP.138xH.54 mm	0,75		3258950307008





COMPOSIÇÕES DE CHAVES DE CAIXA 1/4"

JOGO DE CHAVES DE CAIXA - 1/4" - 13 PEÇAS

→ Chaves de caixa 1/4" sextavadas: 4-4,5-5-5,5-6-7-8-9-10-11-12-13-14 mm.



E194675	1/4"	Qde	Peso g	☒	EAN
E194675	1/4"	13	370	10	3258951946756

JOGO DE CHAVES DE CAIXA - 1/4" - 22 PEÇAS

- Chaves de caixa 1/4" 6 faces: 4-4,5-5-5,5-6-7-8-9-10-11-12-13-14 mm.
- Chaves de caixa sextavadas: 2-3-4-6 mm.
- Chaves de caixa Torx®: T20-T25-T30.
- 1 roquete parquímetro de bloqueio 1/4".
- 1 extensão 1/4": 150 mm.
- Entregue em expositor.



E030727	1/4"	Qde	Peso g	☒	EAN
E030727	1/4"	22	626	1	3258950307275



MÓDULO DE CHAVES DE CAIXA E ACESSÓRIOS - 1/4" - 67 PEÇAS

- Chaves de caixa 1/4" sextavadas: 4-4,5-5-5,5-6-7-8-9-10-11-12-13-14 mm.
- Chaves de caixa longas 1/4" sextavadas: 4-5-5,5-6-7-8-9-10-11-12-13-14 mm.
- Chaves de caixa aparafusadoras sextavadas 1/4": 2-2,5-3-4-5-6-7-8 mm.
- Chaves de caixa aparafusadoras Torx® 1/4": T6-T7-T8-T9-T10-T15-T20-T25-T27-T30.
- 1 roquete de cabeça articulada 1/4".
- 1 roquete cabeça corpo longo com bloqueio 1/4".
- 1 pega com cabo 1/4".
- 2 extensões 1/4": 55-100 mm.
- 1 cardan 1/4".
- 1 cabo T correção 1/4".
- 1 chave de punho porta-bits 1/4".
- Pontas de fenda: 4-5,5-6,5 mm.
- Pontas Pozidriv®: PZ1-PZ2-PZ3.
- Pontas sextavadas: 3-4-5-6 mm.
- Pontas Resistorx®: TT10-TT15-TT20-TT25-TT30-TT40.
- Tabuleiro vazio: E030716.



E030715	1/4"	Qde	Peso kg	☒	EAN
E030715	1/4"	67	1,7	1	3258950307152

MÓDULO DE CHAVES DE CAIXA E ACESSÓRIOS - 1/4" - 45 PEÇAS

- Chaves de caixa sextavadas 1/4": 4-4,5-5-5,5-6-7-8-9-10-11-12-13-14 mm.
- Pontas de fenda 1/4": 4-5,5-6,5 mm.
- Pontas Pozidriv® 1/4": PZ1-PZ2-PZ3.
- Pontas sextavadas 1/4": 3-4-5-6 mm.
- Pontas Torx® -1/4": T10-T15-T20-T25-T30-T40.
- 1 roquete cabeça corpo longo com bloqueio 1/4".
- 2 extensões 1/4": 55-100 mm.
- 1 chave de punho porta acessórios com cabo em bi-matéria.
- 1 adaptador 1/4" para ponteiras 1/4".
- 1 cardan 1/4".
- 9 chaves macho em suporte: 1,5-2-2,5-3-4-5-6-7-8-10 mm.
- Tabuleiro vazio: E030701.



E194680	1/4"	Qde	Peso kg	☒	EAN
E194680	1/4"	45	1,3	1	3258950306018





ROQUETES 1/4"

ROQUETE DE CABEÇA REDONDA 1/4"

- ISO 3315 - DIN 3122 - ISO 1174-1
- Mecanismo 72 dentes.
- Ângulo de curvatura 5°.
- Cabeça compacta.
- Acabamento: cromado pólido.
- Cabo em bi-matéria ergonómico.



	d1 mm	d2 mm	L mm	Peso g		EAN
E030601	24.8	23.5	140	98	10	3258950306018

ROQUETE COM BLOQUEIO 1/4"

- ISO 3315 - DIN 3122 - ISO 1174-1
- Mecanismo 72 dentes.
- Ângulo de curvatura 5°.
- Bloqueio de segurança da chave de caixa.
- Inversão por alavanca: visualização do sentido de rotação.
- Acabamento: crómio pólido.
- Cabo em Bi-matéria ergonómico.



	d1 mm	d2 mm	L mm	Peso g		EAN
E030605	24	22	140	125	10	3258950306056

ROQUETE COM MECANISMO BLOQUEIO - 1/4" CABO EM METAL

- ISO 3315 - DIN 3122 - ISO 1174-1
- Mecanismo 72 dentes.
- Ângulo de curvatura 5°.
- Bloqueio de segurança da chave de caixa.
- Inversão por alavanca: visualização do sentido de rotação.
- Acabamento: cromado pólido.

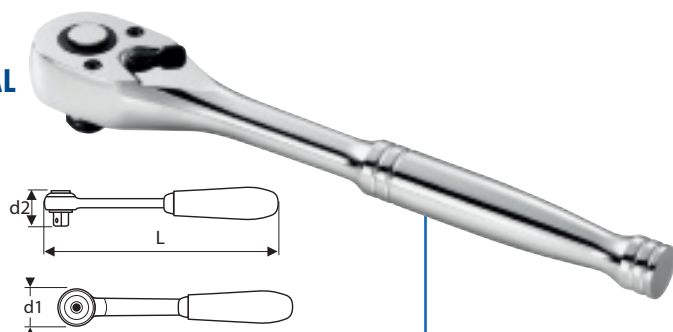

	d1 mm	d2 mm	L mm	Peso g		EAN
E030508	24	22	140	136	10	3258950305080

ROQUETE DE CABEÇA ARTICULADA 1/4"

- ISO 3315 - DIN 3122 - ISO 1174-1
- Mecanismo 72 dentes.
- Ângulo de curvatura 5°.
- Cabeça compacta e articulada para uma acessibilidade acrescida.
- Acabamento: crómio brilhante.
- Cabo em Bi-matéria ergonómico.

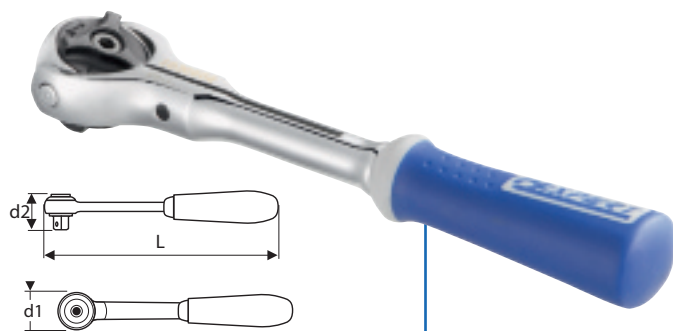

	d1 mm	d2 mm	L mm	Peso g		EAN
E030602	31.6	23.5	150,5	130	1	3258950306025



ACESSÓRIOS 1/4"

CHAVE DE PUNHO 1/4"

- ISO 3315 - DIN 3122
- Cabo em bi-matéria ergonómico.
- Aço de cromo-vanádio.
- Acabamento: cromado pólido.
- Para uma utilização manual.



	L mm	Peso g		EAN
E113910	158	70	5	3258951139103

CABO T CORREDIÇÃO - 1/4"

- ISO 3315 - DIN 3122 - ISO 1174-1
- Aço de cromo-vanádio.
- Acabamento: cromado pólido.
- Para uma utilização manual.



	L mm	Peso g		EAN
E117355	105	45	10	3258951173558

EXTENSÕES 1/4"

- ISO 3315 - DIN 3122 - ISO 1174-1
- Aço de cromo vanádio.
- Acabamento: cromo brilhante.

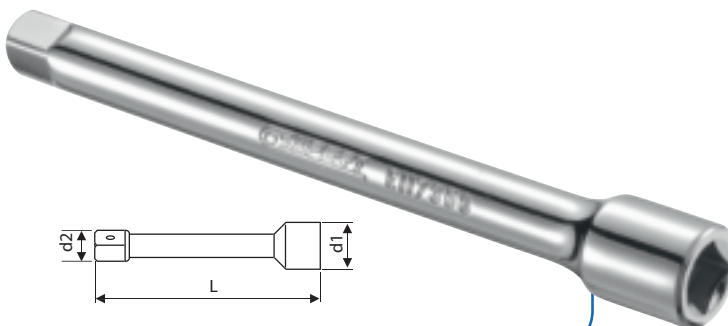

	d1 mm	d2 mm	L mm	Peso g		EAN
E113771	12.5	8.51	55	25	10	3258951137710
E117356	12.5	8.51	100	45	10	3258951173565
E113772	12.5	8.51	150	65	10	3258951137727

EXTENSÃO FLEXÍVEL 1/4"

- Ideal para o aperto e desaperto em espaços restritos.
- Corpo flexível.
- Utilização manual (sem ferramentas energizadas).



		EAN
E030509	1	3258950305097





ACESSÓRIOS 1/4"

AUMENTO 1/4" - 3/8"

- ISO 3315 - DIN 3122 - ISO 1174-1
- Aço de cromo-vanádio.
- Acabamento: cromado pólido.
- Para uma utilização manual.

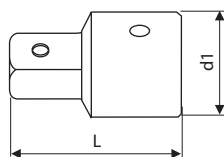

E117358	d1 mm	d2 mm	L mm	Peso g		EAN
E117358	12.4	8.51	25	16	10	3258951173589

ADAPTADOR MAGNÉTICO 1/4" - 3/8"

- Utilização apenas com ferramentas manuais.
- - Magnetizado.
- Entregue em expositor metálico.

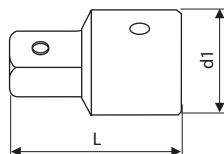

E041505		d1 mm	L mm	Peso g		EAN
E041505	1/4" - 3/8"	19	14,5	18	1	3258950415055

CHAVE DE CAIXA 1/4" PORTA-BITS 1/4"

- ISO 1173 - DIN 3126 - ISO 1174-1
- Aço de cromo-vanádio.
- Acabamento: cromado pólido.
- Para uma utilização manual.

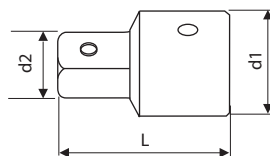

E117359	d1 mm	d2 mm	L mm	Peso g		EAN
E117359	14	8.51	25	25	10	3258951173596

CARDAN - 1/4"

- ISO 3316 - DIN 3123 - ISO 1174-1
- Aço de cromo-vanádio.
- Acabamento: cromado pólido.
- Para uma utilização manual.

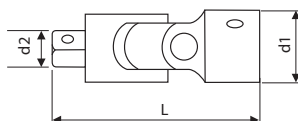

E117360	d1 mm	d2 mm	L mm	Peso g		EAN
E117360	14	8.51	25,20	22	10	3258951173602



CHAVES DE CAIXA 1/4"

CHAVES DE CAIXA 1/4" - SEXTAVADAS - MÉTRICAS

- ISO 2725-1 - DIN 3124 - ISO 1174-1 - ISO 1711-1 - ISO 691
- Aço de cromo-vanádio.
- Perfil Maxi Drive: transmissão do binário de aperto nos flancos da porca e não nas arestas.
- Acabamento: cromo pólido.
- Para uma utilização manual.

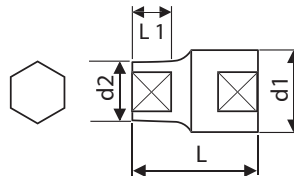

	A mm	d1 mm	d2 mm	L mm	L1 mm	Peso g	☒	EAN
E117293	4	12	6.9	25	3.6	10	10	3258951172933
E117688	4,5	12	7.5	25	3.6	10	10	3258951176887
E117294	5	12	8.1	25	4.2	10	10	3258951172940
E117295	5,5	12	8.8	25	4.2	10	10	3258951172957
E117296	6	12	9.4	25	4.8	10	10	3258951172964
E117297	7	12	10.9	25	5.4	12	10	3258951172971
E117298	8	12	12	25	5.4	12	10	3258951172988
E117299	9	13.2	13.2	25	6	14	10	3258951172995
E117350	10	14.7	14.7	25	7	18	10	3258951173503
E117351	11	16	16	25	8	24	10	3258951173510
E117352	12	16.9	16.9	25	8	24	10	3258951173527
E117353	13	17.7	17.7	25	8	26	10	3258951173534
E117354	14	19.7	19.7	25	10	34	10	3258951173541

CHAVES DE CAIXA 1/4" - 12 FACES - MÉTRICAS

- ISO 2725-1 - DIN 3124 - ISO 1174-1 - ISO 1711-1 - ISO 691
- Aço de cromo-vanádio.
- Perfil Maxi Drive: transmissão do binário de aperto nos flancos da porca e não nas arestas.
- Acabamento: cromo pólido.
- Para uma utilização manual.

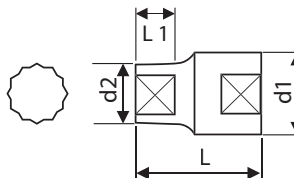

	A mm	d1 mm	d2 mm	L mm	L1 mm	Peso g	☒	EAN
E030210	6	12	9.4	25	4.8	10	10	3258950302102
E030201	7	12	10.9	25	5.4	12	10	3258950302010
E030202	8	12	12	25	5.4	12	10	3258950302027
E030203	9	13.2	13.2	25	6	14	10	3258950302034
E030204	10	14.7	14.7	25	7	18	10	3258950302041
E030205	11	16	16	25	8	24	10	3258950302058
E030206	12	16.9	16.9	25	8	24	10	3258950302065
E030207	13	17.7	17.7	25	8	26	10	3258950302072
E030211	14	19.7	19.7	25	10	34	10	3258950302119





CHAVES DE CAIXA 1/4"

CHAVES DE CAIXA 1/4" - 12 FACES - POLEGADAS

- ASME B 107-1 - ISO 1174-1
- Aço de cromo-vanádio.
- Perfil Maxi Drive: transmissão do binário de aperto nos flancos da porca e não nas arestas.
- Acabamento: cromo pólido.
- Para uma utilização manual.

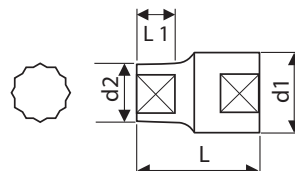

	A"	d1 mm	d2 mm	L mm	L1 mm	Peso g	☒	EAN
E113740	3/16"	12	8	25	3.6	7	10	3258951137406
E113741	7/32"	12	9	25	4.2	8	10	3258951137413
E113742	1/4"	12	10	25	4.8	8	10	3258951137420
E113743	9/32"	12	11	25	4	10	10	3258951137437
E113744	5/16"	12	12	25	4	10	10	3258951137444
E113745	11/32"	13.2	13.2	25	4.5	10	10	3258951137451
E113746	3/8"	14.7	14.7	25	4.5	14	10	3258951137468
E113748	7/16"	16	16	25	6	17	10	3258951137482
E113749	1/2"	17.7	17.7	25	7.2	19	10	3258951137499
E113750	9/16"	18.7	18.7	25	10	25	10	3258951137505

CHAVES DE CAIXA LONGAS 1/4" - SEXTAVADAS - MÉTRICAS

- ISO 2725-1 - DIN 3124 - ISO 1174-1 - ISO 1711-1 - ISO 691
- Aço de cromo-vanádio.
- Perfil Maxi Drive: transmissão do binário de aperto nos flancos da porca e não nas arestas.
- Acabamento: cromo pólido.
- Para uma utilização manual.

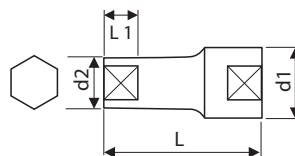

	A mm	d1 mm	d2 mm	L mm	L1 mm	Peso g	☒	EAN
E113751	4	11.8	6.9	49.5	5	18	10	3258951137512
E113752	5	11.8	8	49.5	5.5	18	10	3258951137529
E113753	5.5	11.8	8	49.5	5.5	18	10	3258951137536
E113754	6	11.8	9.4	49.5	6.5	18	10	3258951137543
E113755	7	11.8	10.9	49.5	10.5	27	10	3258951137550
E113756	8	11.8	11.8	49.5	10.5	27	10	3258951137567
E113757	9	12.8	12.8	49.5	11.5	32	10	3258951137574
E113758	10	14.5	14.5	49.5	13	41	10	3258951137581
E113759	11	15.6	15.6	49.5	14	15	10	3258951137598
E113760	12	16	16	49.5	15	50	10	3258951137604
E113761	13	17	17	49.5	17	59	10	3258951137611
E113762	14	19	19	49.5	19	68	10	3258951137628



CHAVES DE CAIXA LONGAS 1/4" - SEXTAVADAS - POLEGADAS

→ ISO 2725-1 - DIN 3124 - ISO 1174-1 - ISO 1711-1 - ISO 691

- Aço de cromo vanádio.
- Perfil Maxi Drive: transmissão do binário de aperto nos flancos da porca e não nas arestas.
- Acabamento: cromo brilhante.
- Para uma utilização manual.

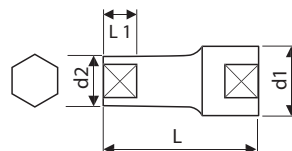

	A"	d1 mm	d2 mm	L mm	L1 mm	Peso g	☒	EAN
E030310	3/16"	11,8	8	49,5	5	18	10	3258950303109
E030311	7/32"	11,8	9	49,5	5,5	18	10	3258950303116
E030312	1/4"	11,8	10	49,5	6,5	23	10	3258950303123
E030313	9/32"	11,8	11	49,5	6,5	26	10	3258950303130
E030314	5/16"	11,8	11,8	49,5	10,5	27	10	3258950303147
E030315	11/32"	12,8	12,8	49,5	11,5	32	10	3258950303154
E030316	3/8"	14,5	14,5	49,5	12,5	41	10	3258950303161
E030317	7/16"	15,6	15,6	49,5	14,5	45	10	3258950303178
E030318	1/2"	17,6	17,6	49,5	16,5	59	10	3258950303185
E030322	9/16"	19,6	19,6	49,5	19	68	10	3258950303222

CHAVES DE CAIXA LONGAS 1/4" - 12 FACES - MÉTRICAS

→ ISO 2725-1 - DIN 3124 - ISO 1174-1 - ISO 1711-1 - ISO 691

- Aço de cromo-vanádio.
- Perfil Maxi Drive: transmissão do binário de aperto nos flancos da porca e não nas arestas.
- Acabamento: cromo pólido.
- Para uma utilização manual.

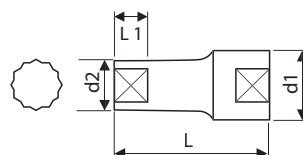

	A mm	d1 mm	d2 mm	L mm	L1 mm	Peso g	☒	EAN
E030216	6	11,8	9,4	49,50	6,5	18	10	3258950302164
E030217	7	11,8	10,9	49,50	10,5	27	10	3258950302171
E030218	8	11,8	11,8	49,50	10,5	27	10	3258950302188
E030219	9	12,8	12,8	49,50	11,5	32	10	3258950302195
E030220	10	14,5	14,5	49,50	13	41	10	3258950302201
E030221	11	15,6	15,6	49,50	14	45	10	3258950302218
E030222	12	16,6	16,6	49,50	15	50	10	3258950302225
E030223	13	17,6	17,6	49,50	17	59	10	3258950302232
E030224	14	19,6	19,6	49,50	19	68	10	3258950302249

CHAVES DE CAIXA LONGAS 1/4" - 12 FACES - POLEGADAS

→ ASME B 107-1 - ISO 1174-1

- Aço de cromo-vanádio.
- Perfil Maxi Drive: transmissão do binário de aperto nos flancos da porca e não nas arestas.
- Acabamento: cromo pólido.
- Para uma utilização manual.

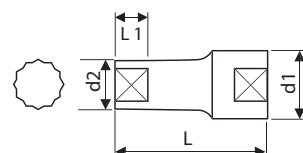

	A"	d1 mm	d2 mm	L mm	L1 mm	Peso g	☒	EAN
E113763	1/4"	11,8	10	49,5	6,5	17	10	3258951137635
E113764	3/8"	14,5	14,5	49,5	12,5	32	10	3258951137642
E113765	5/16"	11,8	11,8	49,5	10,5	23	10	3258951137659
E113766	7/16"	15,6	15,6	49,5	14,5	40	10	3258951137666
E113767	9/16"	19,6	19,6	49,5	19	49	10	3258951137673
E113768	9/32"	11,8	11,8	49,5	6,5	17	10	3258951137680





CHAVES DE CAIXA TORX® 1/4"

CHAVES DE CAIXA TORX® 1/4"

- ISO 1174-1
- Para parafusos macho Torx®.
- Aço com crómio-vanádio.
- Acabamento: crómio brilhante.

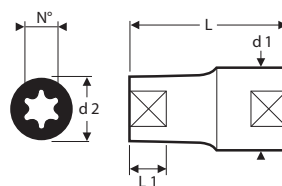

	N°	d1 mm	d2 mm	L mm	L1 mm	Peso g		EAN
E030129	E4	12	6.1	25	3.6	8	10	3258950301297
E030130	E5	12	6.9	25	4.2	8	10	3258950301303
E030131	E6	12	8	25	4.8	8	10	3258950301310
E030132	E7	12	8.8	25	5.4	8	10	3258950301327
E030133	E8	12	10.2	25	5.4	9	10	3258950301334
E030134	E10	12	12	25	7	11	10	3258950301341
E030150	E11	12	12.8	25	6	14	1	3258950301501
E030151	E12	12	15.7	25	9	22	1	3258950301518

CHAVES DE CAIXA 1/4"

JOGOS DE CHAVES DE CAIXA

- E030704: Sextavadas 2-2,5-3-4-5-6-7-8 mm.
- E030703: Torx® T6-T7-T8-T9-T10-T15-T20-T25-T27-T30.
- Fornecido em expositor metálico.

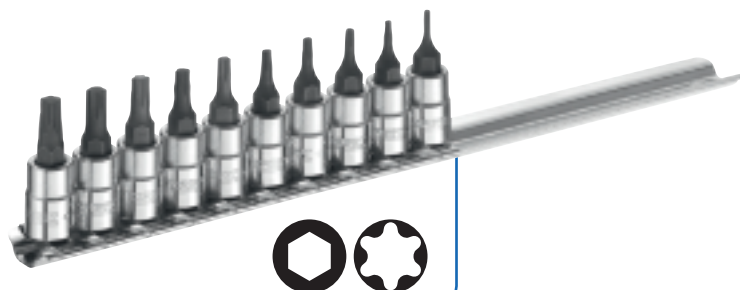

		Qde	Peso g		EAN
E030704	1/4"	8	150	1	3258950307046
E030703	1/4"	10	190	1	3258950307039

CHAVES DE CAIXA 1/4" PARA PARAFUSOS SEXTAVADOS INTERIORES

- ISO 2725-1 - DIN3124 - ISO 1174-1
- Aço de crómio vanádio.
- Acabamento: crómio pólido.

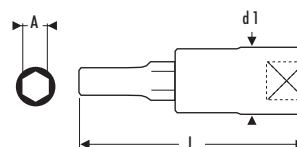

	A mm	d1 mm	L mm	Peso g		EAN
E030101	2	12	33	18	10	3258950301013
E030102	2,5	12	33	18	10	3258950301020
E030103	3	12	33	18	10	3258950301037
E030104	4	12	33	18	10	3258950301044
E030105	5	12	33	19	10	3258950301051
E030106	6	12	33	20	10	3258950301068
E030107	7	12	33	21	10	3258950301075
E030108	8	12	33	22	10	3258950301082

CHAVES DE CAIXA 1/4" PARA PARAFUSOS DE FENDA

- ISO 2725-1 - DIN3124 - ISO 1174-1
- Aço de crómio vanádio.
- Acabamento: crómio pólido.

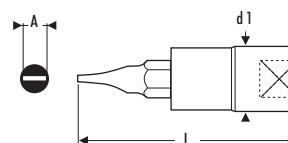

	A mm	d1 mm	L mm	Peso g		EAN
E030109	4	12	33	12	10	3258950301099
E030110	5,5	12	33	12	10	3258950301105
E030111	7	12	33	12	10	3258950301112



CHAVES DE CAIXA 1/4" PARA PARAFUSOS PHILLIPS®

- ISO 2725-1 - DIN3124 - ISO 1174-1
- Aço de cromo vanádio.
- Acabamento: cromo pólido.

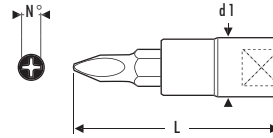

	N°	d1 mm	L mm	Peso g		EAN
E030115	PH1	12	33	12	10	3258950301150
E030116	PH2	12	33	12	10	3258950301167
E030117	PH3	12	33	12	10	3258950301174



CHAVES DE CAIXA 1/4" PARA PARAFUSOS POZIDRIV®

- ISO 2725-1 - DIN3124 - ISO 1174-1
- Aço de cromo vanádio.
- Acabamento: cromo pólido.

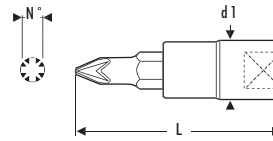

	N°	d1 mm	L mm	Peso g		EAN
E030112	PZ1	12	33	12	10	3258950301129
E030113	PZ2	12	33	12	10	3258950301136
E030114	PZ3	12	33	12	10	3258950301143



CHAVES DE CAIXA 1/4" PARA PARAFUSOS TORX® INTERIORES

- ISO 1174-1
- Aço de cromo vanádio.
- Acabamento: cromo pólido.

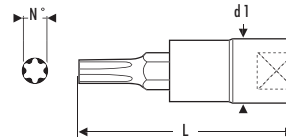

	N°	d1 mm	L mm	Peso g		EAN
E030118	T6	12	33	17	10	3258950301181
E030119	T7	12	33	17	10	3258950301198
E030120	T8	12	33	17	10	3258950301204
E030121	T9	12	33	17	10	3258950301211
E030122	T10	12	33	17	10	3258950301228
E030123	T15	12	33	17	10	3258950301235
E030124	T20	12	33	18	10	3258950301242
E030125	T25	12	33	18	10	3258950301259
E030126	T27	12	33	18	10	3258950301266
E030127	T30	12	33	18	10	3258950301273
E030128	T40	12	33	18	10	3258950301280



CHAVES DE CAIXA 1/4" PARA PARAFUSOS RESISTORX® INTERIORES

- ISO 1174-1
- Aço de cromo vanádio.
- Acabamento: cromo pólido.

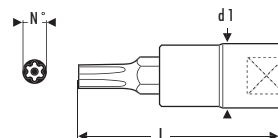

	N°	d1 mm	L mm	Peso g		EAN
E030142	TT8	12	33	17	10	3258950301426
E030143	TT10	12	33	17	10	3258950301433
E030144	TT15	12	33	17	10	3258950301440
E030145	TT20	12	33	18	10	3258950301457
E030146	TT25	12	33	18	10	3258950301464
E030147	TT27	12	33	18	10	3258950301471
E030148	TT30	12	33	18	10	3258950301488
E030149	TT40	12	33	18	10	3258950301495





COMPOSIÇÕES DE CHAVES DE CAIXA 3/8"

CAIXA DE CHAVES DE CAIXA E ACESSÓRIOS - 3/8" MÉTRICAS - 61 PEÇAS

- Chaves de caixa 3/8" 12 faces: 6-7-8-9-10-11-12-13-14-15-16-17-18-19-20-21-22-23-24 mm.
- Chaves de caixa longas 3/8" sextavadas: 8-9-10-11-12-13-14-15-17-19 mm.
- Chaves de caixa aparafusadoras sextavadas 3/8": 3-4-5-6-7-8-10 mm.
- Chaves de caixa aparafusadoras Torx® 3/8": T8-T10-T15-T20-T25-T27-T30-T40-T45-T50.
- Chaves de caixa aparafusadoras Pozidriv® 3/8": PZ1-PZ2-PZ3.
- Chaves de caixa aparafusadoras Phillips® 3/8": PH1-PH2-PH3.
- Chaves de caixa 3/8" para velas 16 e 21 mm.
- 1 roquete com bloqueio 3/8".
- 2 extensões 3/8": 75-250 mm.
- 1 cabo T correção 3/8".
- 1 redutor de 1/2" - 3/8"
- 1 cardan universal 3/8".
- Fornecido em caixa compatível com gaveta de carro.



		Qde	Dimensões	Peso kg		EAN
E031806	3/8"	61	L.415xP.283xH.92 mm	5	1	3258950318066

CAIXA DE CHAVES DE CAIXA 3/8" DE 12 FACES - MÉTRICAS - 22 PEÇAS

- Chaves de caixa 3/8" 12 faces: 6-7-8-9-10-11-12-13-14-15-16-17-18-19-21-22-24 mm.
- 1 roquete com bloqueio 3/8".
- 2 extensões 3/8": 75-125 mm.
- 1 chave de caixa 3/8" porta-pontas 1/4".
- 1 cardan universal 3/8".
- Fornecido em caixa compatível com gaveta de carro.



		Qde	Dimensões	Peso kg		EAN
E031805	3/8"	22	L.275xP.186xH.80 mm	1,5	1	3258950318059

CAIXA DE CHAVES DE CAIXA LONGAS 3/8" SEXTAVADAS - MÉTRICAS - 15 PEÇAS

- Chaves de caixa longas 3/8" sextavadas: 7-8-9-10-11-12-13-14-15-16-17-18-19-21-22 mm.
- Fornecido em caixa compatível com gaveta de carro.



		Qde	Dimensões	Peso kg		EAN
E031804	3/8"	15	L.275xP.186xH.80 mm	1,5	1	3258950318042



MÓDULO DE CHAVES DE CAIXA E ACESSÓRIOS 3/8" MÉTRICAS - 50 PEÇAS

- Chaves de caixa 3/8" 12 faces: 8-9-10-11-12-13-14-15-16-17-18-19-21-22 mm.
- Chaves de caixa longas 3/8" sextavadas: 8-10-11-12-13-14-15-16-17-18-19-21-22 mm.
- Chaves de caixa sextavadas 3/8": 5-6-8-10-12 mm.
- Chaves de caixa de fenda 3/8": 5,5-7-8 mm.
- Chaves de caixa Torx® 3/8": T25-T27-T30-T40-T45-T50.
- Chaves de caixa Pozidriv® 3/8": PZ1-PZ2-PZ3.
- Chaves de caixa Phillips® 3/8": PH1-PH2-PH3.
- 1 extensão 3/8": 125 mm.
- 1 cardan 3/8".
- 1 roquete parquímetro de bloqueio 3/8".
- Tabuleiro vazio: E031822



E031821	3/8"	Qde	Peso kg	✉	EAN
		50	2,8	1	3258950318219



MÓDULO DE CHAVES DE CAIXA E ACESSÓRIOS 3/8" MÉTRICAS - 20 PEÇAS

- Chaves de caixa 3/8" 12 faces: 7-8-9-10-11-12-13-14-15-16-17-18-19-20-21-22 mm.
- 1 roquete parquímetro de bloqueio 3/8".
- 2 extensões 3/8": 125-250 mm.
- 1 cardan 3/8".
- Tabuleiro vazio: E031802.



E194678	3/8"	Qde	Peso kg	✉	EAN
		20	1,5	1	3258951946787



JOGO DE CHAVES DE CAIXA 3/8" SEXTAVADAS - 13 PEÇAS

- Chaves de caixa 3/8" sextavadas: 1/4"-5/16"-11/32"-3/8"-7/16"-1/2"-9/16"-5/8"-11/16"-3/4"-13/16"-7/8"-1".
- Fornecido em expositor metálico.



E031803	3/8"	Qde	Peso g	✉	EAN
		13	850	1	3258950318035





ROQUETES 3/8"

ROQUETE DE CABEÇA REDONDA 3/8"

- ISO 3315 - DIN 3122 - ISO 1174-1
- Mecanismo 72 dentes.
- Ângulo de curvatura 5°.
- Cabeça compacta.
- Acabamento: crómio pólido.
- Cabo em bi-matéria ergonómico.

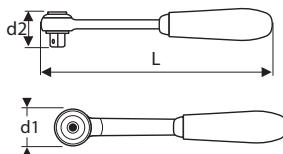

E031701	d1 mm	d2 mm	L mm	Peso g	☒	EAN
E031701	34.5	31.6	199	250	10	3258950317014

ROQUETE COM BLOQUEIO 3/8"

- ISO 3315 - DIN 3122 - ISO 1174-1
- Mecanismo 72 dentes.
- Ângulo de curvatura 5°.
- Bloqueio de segurança da chave de caixa.
- Inversão por alavanca: visualização do sentido de rotação.
- Acabamento: crómio pólido.
- Cabo em bi-matéria ergonómico.

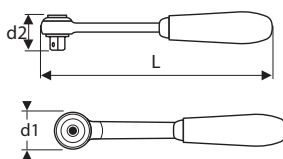

E031706	d1 mm	d2 mm	L mm	Peso g	☒	EAN
E031706	32	29.5	300	285	1	3258950317069

ROQUETE COM MECANISMO BLOQUEIO - 3/8" CABO EM METAL

- ISO 3315 - DIN 3122 - ISO 1174-1
- Mecanismo 72 dentes.
- Ângulo de retoma de 5°.
- Bloqueio de segurança da chave de caixa.
- Inversão por alavanca: visualização do sentido de rotação.
- Acabamento: crómio pólido.

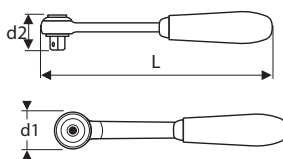
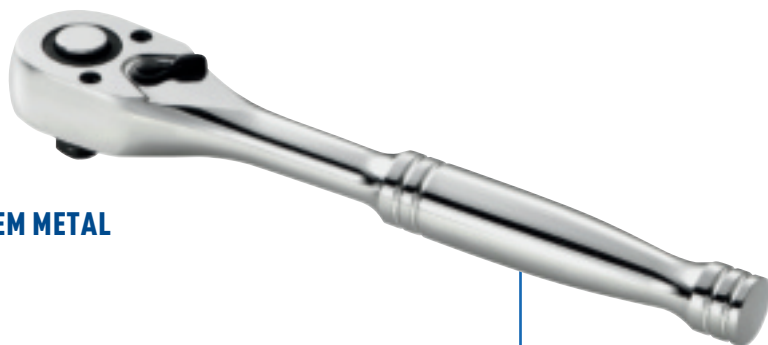

E031612	d1 mm	d2 mm	L mm	Peso g	☒	EAN
E031612	32	30.8	199	322	1	3258950316123





ROQUETE COM CABEÇA ARTICULADA 3/8"

- ISO 3315 - DIN 3122 - ISO 1174-1
- Mecanismo 72 dentes.
- Ângulo de curvatura 5°.
- Cabo articulado para uma acessibilidade acrescida.
- Cabo de grande comprimento para um desaperto mais potente.
- Bloqueio de segurança da chave de caixa.
- Inversão por alavanca: visualização do sentido de rotação.
- Acabamento: crómio pólido.
- Cabo em bi-matéria ergonómico.

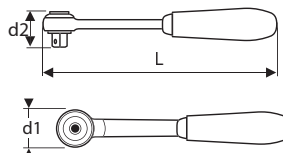
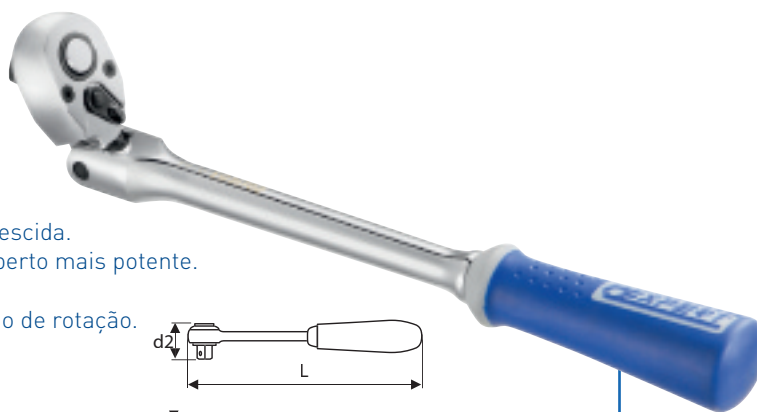

E031702	d1 mm	d2 mm	L mm	Peso g	☒	EAN
E031702	30	31	275	390	1	3258950317021

ROQUETE DE CABEÇA ARTICULADA 3/8"

- ISO 3315 - DIN 3122 - ISO 1174-1
- Mecanismo 72 dentes.
- Ângulo de curvatura 5°.
- Cabeça compacta e articulada para uma acessibilidade acrescida.
- Acabamento: crómio pólido.
- Cabo em bi-matéria ergonómico.

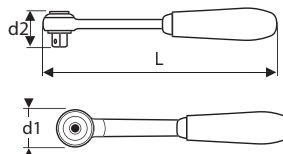
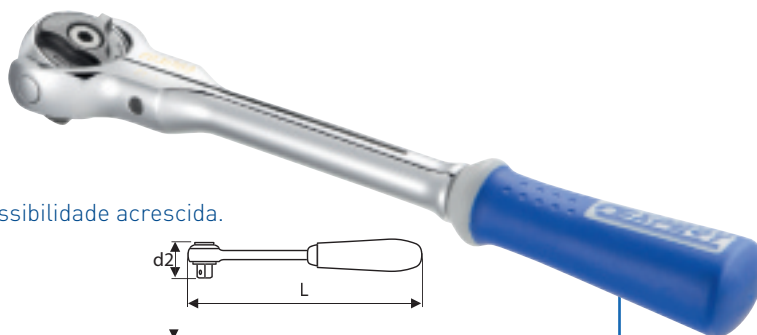

E031703	d1 mm	d2 mm	L mm	Peso g	☒	EAN
E031703	43.6	31.5	234,2	380	1	3258950317038

ACESSÓRIOS 3/8"

MANIVELA 3/8"

- ISO 3315 - DIN 3122 - ISO 1174-1
- Grande rapidez de manobra.
- Punho giratório.



E031604	L mm	Peso g	☒	EAN
E031604	410	395	1	3258950316048





ACESSÓRIOS 3/8"

PEGA ARTICULADA 3/8"

- ISO 3315 - DIN 3122 - ISO 1174-1
- Articulação travada.
- Cabo articulado para uma acessibilidade acrescida.
- Acabamento: crómio brilhante.
- Pega de dupla matéria ergonómica.



	L mm	Peso g		EAN
E031603	375	365	1	3258950316031
E031602	200	211	1	3258950316024

CABO EM T CORREDIÇO 3/8"

- ISO 3315 - DIN 3122 - ISO 1174-1
- Cabeça corrediça.
- Aço de crómio-vanádio.
- Acabamento: crómio pólido.
- Para uma utilização manual.

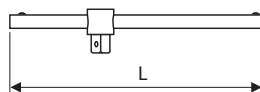

	L mm	Peso g		EAN
E117361	170	128	1	3258951173619

EXTENSÕES 3/8"

- ISO 3315 - DIN 3122 - ISO 1174-1
- Aço de crómio-vanádio.
- Acabamento: crómio pólido.
- Para uma utilização manual.

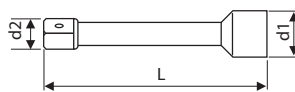
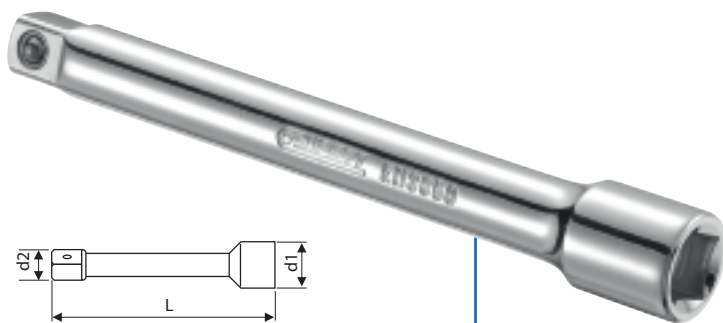

	d1 mm	d2 mm	L mm	Peso g		EAN
E113850	17	12.3	125	120	10	3258951138502
E117363	17	12.3	75	75	10	3258951173633
E117364	17	12.3	250	230	10	3258951173640



EXTENSÃO FLEXÍVEL 3/8" - 200 MM

- Ideal para o aperto e desaperto em espaços restritos.
- Corpo flexível.
- Utilização manual (sem ferramentas energizadas).

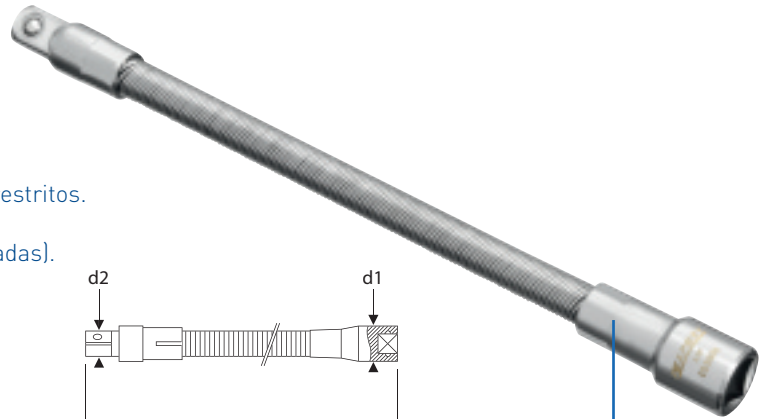

E031614	d1 mm	d2 mm	L mm	Peso g	☒	EAN
E031614	16,2	12,8	200	112	1	3258950316147

CHAVE DE CAIXA 3/8" PORTA-PONTEIRAS 1/4"

- ISO 3315 - DIN 3122 - ISO 1174-1
- Aço de cromo vanádio.
- Acabamento: cromo pólido.
- Para uma utilização manual.

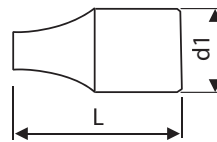

E113851	d1 mm	L mm	Peso g	☒	EAN
E113851	17	25,40	24	1	3258951138519

REDUTOR 3/8" - 1/4"

- ISO 3316 - DIN 3123 - ISO 1174-1
- Acabamento: cromo pólido.
- Aço de cromo vanádio.
- Para uma utilização manual.

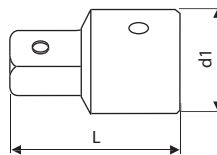

E117365	d1 mm	L mm	Peso g	☒	EAN
E117365	17	25,40	20	1	3258951173657

ADAPTADOR MAGNÉTICO 3/8" - 1/2"

- Utilização apenas com ferramentas manuais.
- Magnetizado.
- Entregue em expositor metálico.

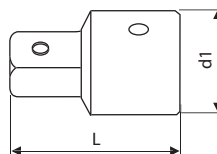

E041506	☒	d1 mm	L mm	Peso g	☒	EAN
E041506	3/8" - 1/2"	25	20	33	1	3258950415062





ACESSÓRIOS 3/8"

AUMENTO 3/8" - 1/2"

- ISO 3316 - DIN 3123 - ISO 1174-1
- Aço de cromo vanádio.
- Acabamento: cromo pólido.
- Para uma utilização manual.

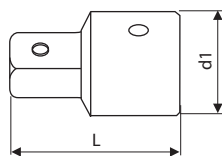

	d1 mm	L mm	Peso g		EAN
E117366	18	36	40	1	3258951173664

CARDAN 3/8"

- ISO 3316 - DIN 3123 - ISO 1174-1
- Aço de cromo vanádio.
- Acabamento: cromo pólido.
- Para uma utilização manual.

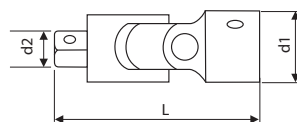

	d1 mm	L mm	Peso g		EAN
E117367	14	29,50	60	10	3258951173671

CHAVES DE CAIXA 3/8"

CHAVES DE CAIXA 3/8" MÉTRICAS - 12 FACES

- ISO 2725-1 - DIN 3124 - ISO 1174-1 - ISO 1711-1 - ISO 691
- Aço de cromo-vanádio.
- Perfil Maxi Drive: transmissão do binário de aperto nos flancos da porca e não nas arestas.
- Acabamento: cromo pólido.
- Para uma utilização manual.

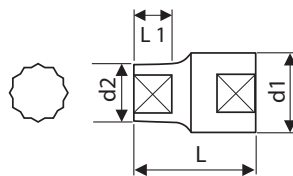

	A mm	d1 mm	d2 mm	L mm	L1 mm	Peso g		EAN
E030933	6	17,1	10,1	25,70	5	18	10	3258950309330
E113830	7	17,1	10,8	25,70	6	18	10	3258951138304
E113831	8	17,1	12	25,70	6	20	10	3258951138311
E113832	9	17,1	13,1	25,70	6,5	20	10	3258951138328
E113833	10	17,1	14,7	25,70	7	20	10	3258951138335
E113834	11	17,1	16	25,70	8	22	10	3258951138342
E113835	12	17,1	17,1	25,70	8,5	22	10	3258951138359
E113836	13	18,3	18,3	25,70	8,5	28	10	3258951138366
E113837	14	19,5	19,5	25,70	10	30	10	3258951138373
E113838	15	20,4	20,4	25,70	10	33	10	3258951138380
E113839	16	22,1	22,1	25,70	10	46	10	3258951138397
E113840	17	23,3	23,3	25,70	10	52	10	3258951138403
E113841	18	24,2	24,2	25,70	11	56	10	3258951138410
E113842	19	25,5	25,5	25,70	12	64	10	3258951138427
E113843	20	26,8	26,8	29	14	68	10	3258951138434
E113844	21	27,7	27,7	29	14	72	10	3258951138441
E113845	22	29,8	29,8	29	14	86	10	3258951138458
E113846	23	30,8	30,8	29	14	90	10	3258951138465
E113847	24	31,8	31,8	29	14	96	10	3258951138472



CHAVES DE CAIXA 3/8" - SEXTAVADAS - MÉTRICAS

- ISO 2725-1 - DIN 3124 - ISO 1174-1 - ISO 1711-1 - ISO 691
- Aço de cromo-vanádio.
- Perfil Maxi Drive: transmissão do binário de aperto nos flancos da porca e não nas arestas.
- Acabamento: cromo pólido.
- Para uma utilização manual.

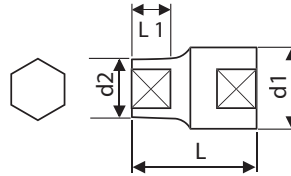

	A mm	d1 mm	d2 mm	L mm	L1 mm	Peso g	☒	EAN
E030935	6	17,1	10,1	25,70	5	18	10	3258950309354
E030936	7	17,1	10,8	25,70	6	18	10	3258950309361
E030937	8	17,1	12	25,70	6	20	10	3258950309378
E030938	9	17,1	13,1	25,70	6,5	20	10	3258950309385
E030939	10	17,1	14,7	25,70	7	20	10	3258950309392
E030940	11	17,1	16	25,70	8	22	10	3258950309408
E030941	12	17,1	17,1	25,70	8,5	22	10	3258950309415
E030942	13	18,3	18,3	25,70	8,5	28	10	3258950309422
E030943	14	19,5	19,5	25,70	10	30	10	3258950309439
E030944	15	20,4	20,4	25,70	10	33	10	3258950309446
E030945	16	22,1	22,1	25,70	10	46	10	3258950309453
E030946	17	23,3	23,3	25,70	10	52	10	3258950309460
E030947	18	24,2	24,2	25,70	11	56	10	3258950309477
E030948	19	25,5	25,5	25,70	12	64	10	3258950309484
E030949	20	26,8	26,8	29	14	68	10	3258950309491
E030950	21	27,7	27,7	29	14	72	10	3258950309507
E030951	22	29,8	29,8	29	14	86	10	3258950309514
E030952	23	30,8	30,8	29	14	90	10	3258950309521
E030953	24	31,8	31,8	29	14	96	10	3258950309538

CHAVES DE CAIXA 3/8" - SEXTAVADAS - POLEGADAS

- ASME B 107-1 - ISO 1174-1
- Aço de cromo-vanádio.
- Perfil Maxi Drive: transmissão do binário de aperto nos flancos da porca e não nas arestas.
- Acabamento: cromo pólido.
- Para uma utilização manual.

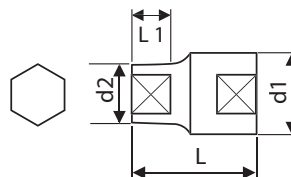

	A "	d1 mm	d2 mm	L mm	L1 mm	Peso g	☒	EAN
E031301	1/4"	17,1	10	25,70	3,2	24	10	3258950313016
E031302	5/16"	17,1	11,7	25,70	4,5	25	10	3258950313023
E031303	11/32"	17,1	13	25,70	5	25	10	3258950313030
E031304	3/8"	17,1	14,2	25,70	5	26	10	3258950313047
E031305	7/16"	17,1	16,3	25,70	7	27	10	3258950313054
E031306	1/2"	18,3	18,3	25,70	7	36	10	3258950313061
E031307	9/16"	19,5	19,5	25,70	9	34	10	3258950313078
E031308	5/8"	22,1	22,1	25,70	10	45	10	3258950313085
E031309	11/16"	24,2	24,2	25,70	10	56	10	3258950313092
E031310	3/4"	25,7	25,7	25,70	12	67	10	3258950313108
E031311	13/16"	27,7	27,7	29	13	74	10	3258950313115
E031312	7/8"	29,8	29,8	29	13	91	10	3258950313122
E031334	15/16"	31,8	31,8	29	13	102	1	3258950313344
E031313	1"	33,2	33,2	35	14	123	10	3258950313139





CHAVES DE CAIXA 3/8"

CHAVES DE CAIXA LONGAS 3/8" - SEXTAVADAS - MÉTRICAS

- ISO 2725-1 - DIN 3124 - ISO 1174-1 - ISO 1711-1 - ISO 691
- Aço com cromo-vanádio.
- Perfil Maxi Drive: transmissão do binário de aperto nos flancos da porca e não nas arestas.
- Acabamento: cromo brilhante.
- Para uma utilização manual.

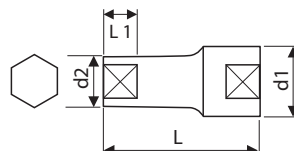

	A mm	d1 mm	d2 mm	L mm	L1 mm	Peso g	☒	EAN
E031502	7	16,5	12	45,5	12	46	10	3258950315027
E031503	8	16,5	12	45,50	12	46	10	3258950315034
E031504	9	16,5	13,1	45,50	14	47	10	3258950315041
E031505	10	16,5	14,7	45,50	15	50	10	3258950315058
E031506	11	16,5	16	45,50	17	53	10	3258950315065
E031507	12	17,1	17,1	45,50	18	53	10	3258950315072
E031508	13	18,5	18,5	45,50	18	54	10	3258950315089
E031509	14	19,5	19,5	50	18	60	10	3258950315096
E031510	15	20,4	20,4	53	20	75	10	3258950315102
E031511	16	22	22	53	20	85	10	3258950315119
E031512	17	23,3	23,3	56	20	102	10	3258950315126
E031513	18	24,2	24,2	56	20	109	10	3258950315133
E031514	19	25,5	25,5	56	20	110	10	3258950315140
E031105	20	26,8	26,8	63,50	22	117	10	3258950311050
E031501	21	27,7	27,7	63,50	22	123	10	3258950315010
E031515	22	29,8	29,8	63,50	22	150	10	3258950315157

CHAVES DE CAIXA LONGAS 3/8" - SEXTAVADAS - POLEGADAS

- ASME B 107-1 - ISO 1174-1
- Aço de cromo-vanádio.
- Perfil Maxi Drive: transmissão do binário de aperto nos flancos da porca e não nas arestas.
- Acabamento: cromo pólido.
- Para uma utilização manual.

	A "	d1 mm	d2 mm	L mm	L1 mm	Peso g	☒	EAN
E031525	1/4"	16,5	9,8	45,5	10	44	10	3258950315256
E031526	5/16"	16,5	11,7	45,5	12	46	10	3258950315263
E031516	3/8"	16,5	14,2	45,5	15	51	10	3258950315164
E031517	7/16"	16,5	16,5	45,5	17	53	10	3258950315171
E031518	1/2"	18,5	18,5	45,5	18	54	10	3258950315188
E031519	9/16"	19,5	19,5	50	18	60	10	3258950315195
E031520	5/8"	22	22	53	20	85	10	3258950315201
E031521	11/16"	24,2	24,2	56	20	109	10	3258950315218
E031522	3/4"	25,7	25,7	56	22	110	10	3258950315225
E031523	13/16"	27,7	27,7	63,5	22	123	10	3258950315232
E031524	7/8"	29,8	29,8	63,5	22	150	10	3258950315249
E031527	15/16"	31,8	31,8	63,5	22	152	10	3258950315270
E031528	1"	33,8	33,8	63,5	22	155	10	3258950315287





CHAVES DE CAIXA TORX® 3/8"

CHAVES DE CAIXA TORX® 3/8"

- ISO 1174-1
- Para parafusos macho Torx®.
- Aço de cromo vanádio.
- Acabamento: cromo pólido.

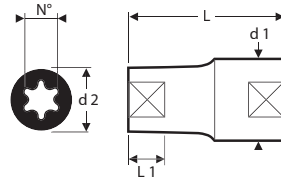

	N°	d1 mm	d2 mm	L mm	Peso g	📦	EAN
E030928	E10	17,1	12,5	29	40	10	3258950309286
E030929	E12	17,1	14,2	29	40	10	3258950309293
E030930	E14	17,1	16	29	50	10	3258950309309
E030931	E16	18,3	17,5	29	100	10	3258950309316

CHAVES DE CAIXA 3/8"

JOGO DE CHAVES DE CAIXA TORX® 3/8" - 4 PEÇAS

- Chaves de caixa aparafusadoras Torx® 3/8": T40-T45-T50-T55.
- Fornecido em expositor metálico.



	Qde	Peso g	📦	EAN
E031807	4	150	10	3258950318073

CHAVES DE CAIXA 3/8" PARA PARAFUSOS SEXTAVADOS INTERIORES

- ISO 2725-1 - DIN3124 - ISO 1174-1
- Aço de cromo vanádio.
- Acabamento: cromo pólido.

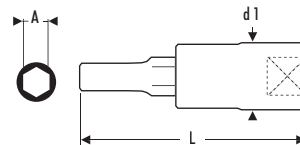

	A mm	d1 mm	L mm	Peso g	📦	EAN
E030901	3	17,9	50	30	10	3258950309019
E030902	4	17,9	50	31	10	3258950309026
E030903	5	17,9	50	32	10	3258950309033
E030904	6	17,9	50	33	10	3258950309040
E030905	7	17,9	50	34	10	3258950309057
E030906	8	17,9	50	43	10	3258950309064
E030934	9	17,9	50	47	10	3258950309347
E030907	10	17,9	50	50	10	3258950309071
E030908	12	22	50	58	10	3258950309088





CHAVES DE CAIXA 3/8"

CHAVES DE CAIXA 3/8" PARA PARAFUSOS DE FENDA

- ISO 2725-1 - DIN3124 - ISO 1174-1
- Aço de cromo vanádio.
- Acabamento: cromo pólio.

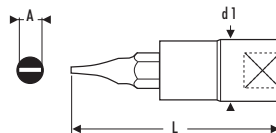

	A mm	d1 mm	L mm	Peso g		EAN
E030909	5,5	17,9	50	33	10	3258950309095
E030910	7	17,9	50	34	10	3258950309101
E030911	8	17,9	50	43	10	3258950309118

CHAVES DE CAIXA 3/8" PARA PARAFUSOS PHILLIPS®

- ISO 2725-1 - DIN3124 - ISO 1174-1
- Aço de cromo vanádio.
- Acabamento: cromo pólio.

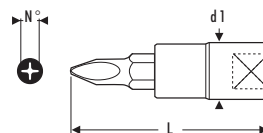

	N°	d1 mm	L mm	Peso g		EAN
E030925	PH1	17,9	50	31	10	3258950309255
E030926	PH2	17,9	50	33	10	3258950309262
E030927	PH3	17,9	50	43	10	3258950309279

CHAVES DE CAIXA 3/8" PARA PARAFUSOS POZIDRIV®

- ISO 2725-1 - DIN3124 - ISO 1174-1
- Aço de cromo vanádio.
- Acabamento: cromo pólio.

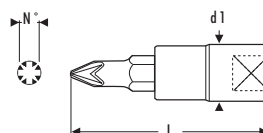

	N°	d1 mm	L mm	Peso g		EAN
E030922	PZ1	17,9	50	31	10	3258950309224
E030923	PZ2	17,9	50	33	10	3258950309231
E030924	PZ3	17,9	50	43	10	3258950309248

CHAVES DE CAIXA 3/8" PARA PARAFUSOS TORX® INTERIORES

- ISO 1174-1
- Aço de cromo vanádio.
- Acabamento: cromo pólio.

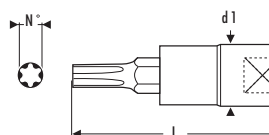

	N°	d1 mm	L mm	Peso g		EAN
E030912	T8	17,9	50	33,5	10	3258950309125
E030913	T10	17,9	50	33,5	10	3258950309132
E030914	T15	17,9	50	33,5	10	3258950309149
E030915	T20	17,9	50	33,5	10	3258950309156
E030916	T25	17,9	50	33,5	10	3258950309163
E030917	T27	17,9	50	33,5	10	3258950309170
E030918	T30	17,9	50	33,5	10	3258950309187
E030919	T40	17,9	50	45	10	3258950309194
E030932	T45	17,9	50	45	10	3258950309323
E030920	T50	17,9	50	48	10	3258950309200
E030921	T55	17,9	50	61	10	3258950309217



COMPOSIÇÕES DE CHAVES DE CAIXA 1/2"

CAIXA DE CHAVES DE CAIXA E ACESSÓRIOS 1/2" - 55 PEÇAS

- Chaves de caixa 1/2" sextavadas: 8-9-10-11-12-13-14-15-16-17-18-19-20-21-22-23-24-25-26-27-28-29-30-32-34 mm.
- Chaves de caixa 1/2" 12 faces: 3/8"-7/16"-1/2"-9/16"-5/8"-11/16"-3/4"-13/16"-7/8"-15/16"-1"-1"1/16"-1"1/8"-1"3/16"-1"1/4".
- Chaves de caixa Torx® 1/2": E10-E11-E12-E14-E16-E18-E20-E24.
- 1 roquete cabeça corpo longo com bloqueio 1/2".
- 2 extensões 1/2": 130-250 mm.
- 1 cabo T correção 1/2".
- 1 cardan 1/2".
- 1 redutor de 1/2" - 3/8".
- 1 aumento 3/8" - 1/2".
- Fornecido em caixa compatível com gaveta de carro.



Ref.	Qde	Dimensões	Peso kg	EAN		
E032909	1/2"	55	L.415xP.283xH.92 mm	6,5	1	3258950329093



CAIXA DE CHAVES DE CAIXA E ACESSÓRIOS - 1/2" MÉTRICAS - 42 PEÇAS

- Chaves de caixa 1/2" sextavadas: 8-9-10-11-12-13-14-15-16-17-18-19-20-21-22-23-24-25-26-27-28-29-30-32 mm.
- Chaves de caixa longas 1/2" sextavadas: 12-13-14-15-16-17-18-19-21-22-24 mm.
- 2 extensões 1/2": 130-250 mm.
- 1 cabo T correção 1/2".
- 1 cardan 1/2".
- 1 redutor de 1/2" - 3/8".
- 1 aumento 3/8" - 1/2".
- 1 roquete cabeça corpo longo com bloqueio 1/2".
- Fornecido em caixa com fechos metálicos, compatível com gaveta de carro.



Ref.	Qde	Dimensões	Peso kg	EAN		
E032908	1/2"	42	L.415xP.283xH.92 mm	5,5	1	3258950329086



CAIXA DE CHAVES DE CAIXA E ACESSÓRIOS - 1/2" MÉTRICAS - 22 PEÇAS

- Chaves de caixa 1/2" sextavadas: 8-10-11-12-13-14-15-16-17-18-19-21-22-24-27-30-32 mm.
- 1 roquete cabeça corpo longo com bloqueio 1/2".
- 1 cabo T correção 1/2".
- 2 extensões 1/2": 130-250 mm.
- 1 cardan 1/2".
- Fornecido em caixa com fechos metálicos, compatível com gaveta de carro.



Ref.	Qde	Dimensões	Peso kg	EAN		
E032900	1/2"	22	L.275xP.186xH.92 mm	4	1	3258950329000





COMPOSIÇÕES DE CHAVES DE CAIXA 1/2"

JOGO DE CHAVES DE CAIXA 1/2" MÉTRICAS - 16 PEÇAS

- Chaves de caixa 1/2" sextavadas: 10-11-12-13-14-15-16-17-18-19-21-22-24-27-30-32 mm.
- Fornecido em expositor metálico.



E032902	1/2"	Qde	Peso kg	☒	EAN
E032902	1/2"	16	1,7	1	3258950329024



EXPOSITOR DE 10 CHAVES DE CAIXA 1/2" MÉTRICAS

- Chaves de caixa 1/2" sextavadas: 9-10-11-12-13-14-15-17-18-19 mm.



E034837	1/4"	Qde	Peso kg	☒	EAN
E034837	1/4"	10	0,715	1	3258950348377



COMPOSIÇÕES DE CHAVES DE CAIXA COM PONTAS TORX 1/2"

CAIXA DE CHAVES DE CAIXA TORX® 1/2" - 16 PEÇAS

- Chaves de caixa aparafusadoras Torx® 1/2": T20-T25-T27-T30-T40-T45-T50-T55-T60.
- Chaves de caixa Torx® 1/2": E10-E12-E14-E16-E18-E20-E24.
- Fornecido em caixa compatível com gaveta de carro.



E032907	1/2"	Qde	Dimensões	Peso kg	☒	EAN
E032907	1/2"	16	L.275xP.186xH.92 mm	1,65	1	3258950329079



CAIXA DE CHAVES TORX® 1/2" - 32 PEÇAS

- Chaves de caixa 1/2 « Torx®: T20, T25, T27, T30, T40, T45, T50, T55, T60, T70 mm, L55 mm.
- Chaves de caixa 1/2 « Torx®: T20, T25, T27, T30, T40, T45, T50, T55, T60, T70 mm, L100 mm.
- Chaves de caixa 1/2 « Torx®: T40, T45, T50, T55, T60, T70 mm, L140 mm.
- Chaves de caixa 1/2 « Torx®: T40, T45, T50, T55, T60, T70 mm, L200 mm.
- Fornecido em caixa compatível com gaveta de carro.



E200514	1/2"	Qde	Dimensões	Peso kg	☒	EAN
E200514	1/2"	32	L.415 x P.314 x H.92 mm	5,15	1	3258952005148





CAIXA DE CHAVES DE CAIXA SEXTAVADAS 1/2" - 30 PEÇAS

- Chaves de caixa 1/2" sextavadas: 5, 6, 7, 8, 10, 12, 14, 17, 19 mm, L55 mm.
- Chaves de caixa 1/2" sextavadas: 5, 6, 7, 8, 10, 11, 12, 13 mm, L100 mm.
- Chaves de caixa 1/2" sextavadas: 5, 6, 7, 8, 10, 12, 14 mm, L140 mm.
- Chaves de caixa 1/2" sextavadas: 5, 6, 7, 8, 10, 12 mm, L200 mm.
- Fornecido em caixa compatível com gaveta de carro.



E200516	1/2"	Qde	Dimensões	Peso kg	1	EAN
		30	L.415 x P.314 x H.92 mm	5	1	3258952005162



CAIXA DE CHAVES 1/2" DE COROA - 32 PEÇAS

- Chaves de caixa 1/2" de coroa:
- L.55 mm: M5, M6, M7, M8, M9, M10, M12, M13, M14.
- L.100 mm: M5, M6, M7, M8, M9, M10, M12, M13, M14.
- L.140 mm: M8, M9, M10, M10,3, M12, M13, M14.
- C.200 mm: M8, M9, M10, M10,3, M12, M13, M14.



E200522	1/2"	Qde	Dimensões	Peso kg	1	EAN
		32	L.415 x P.314 x H.92 mm	5	1	3258952005223



CAIXA DE CHAVES XZN® 1/2" - 26 PEÇAS

- Chaves de caixa 1/2" XZN®: M5, M6, M8, M9, M10, M12, M14, M16 mm, L55 mm.
- Chaves de caixa 1/2" XZN®: M5, M6, M8, M9, M10, M12, M14 mm, L100 mm.
- Chaves de caixa 1/2" XZN®: M5, M6, M8, M9, M10, M12, M14 mm, L140 mm.
- Chaves de caixa 1/2" XZN®: M8, M10, M12, M14 mm, L200 mm.
- Fornecido em caixa compatível com gaveta de carro.



E200515	1/2"	Qde	Dimensões	Peso kg	1	EAN
		26	L.415 x P.314 x H.92 mm	4,4	1	3258952005155





COMPOSIÇÕES DE CHAVES DE CAIXA 1/2"

ESTOJO DE CHAVES DE CAIXA SEXTAVADAS 1/2" - 13 PEÇAS

- Chaves de caixa aparafusadoras sextavadas 1/2": 4-5-6-8-9-10-12 mm.
- Chaves de caixa aparafusadoras sextavadas longas 1/2": 4-5-6-8-10-12 mm.
- Fornecido em caixa compatível com gaveta de carro.



		Qde	Dimensões	Peso kg		EAN
E032906	1/2"	13	L.275xP.186xH.92 mm	1,8	1	3258950329062

JOGO DE CHAVES DE CAIXA 1/2" SEXTAVADAS - 8 PEÇAS

- Chaves de caixa aparafusadoras 1/2" sextavadas: 6-7-8-9-10-12-14-17 mm.
- Fornecido em expositor metálico.



		Qde	Peso g		EAN
E032904	1/2"	8	750	1	3258950329048

JOGO DE CHAVES DE CAIXA SEXTAVADAS 1/2" - 6 PEÇAS

- Chaves de caixa longas 1/2" sextavadas: 5-6-7-8-10-12 mm, C.90 mm.
- Entregue em expositor metálico.



		Qde	Peso g		EAN
E032941	1/2"	6	900	1	3258950329413

JOGO DE CHAVES DE CAIXA TORX® 1/2" - 9 PEÇAS

- Chaves de caixa Torx® 1/2" sextavadas: T20- T25- T27- T30- T40- T45- T50- T55- T60, C.55 mm.
- Entregue em expositor metálico.



		Qde	Peso g		EAN
E032936	1/2"	9	696	1	3258950329369



MODULO DE CHAVES DE CAIXA TORX® 1/2" MÉTRICAS - 33 PEÇAS

- Chaves de caixa aparafusadoras sextavadas 1/2": 5-6-7-8-9-10-12-14-17 mm.
- Chaves de caixa aparafusadoras longas sextavadas 1/2": 4-5-6-8-10-12 mm.
- Chaves de caixa aparafusadoras Torx® 1/2": T20-T25-T27-T30-T40-T45-T50-T55-T60.
- Chaves de caixa Torx® 1/2": E10-E11-E12-E14-E16-E18-E20-E22-E24.
- Tabuleiro vazio: E032923.



E032922	1/2"	Qde	Peso g	☒	EAN
E032922	1/2"	33	2725	1	3258950329222

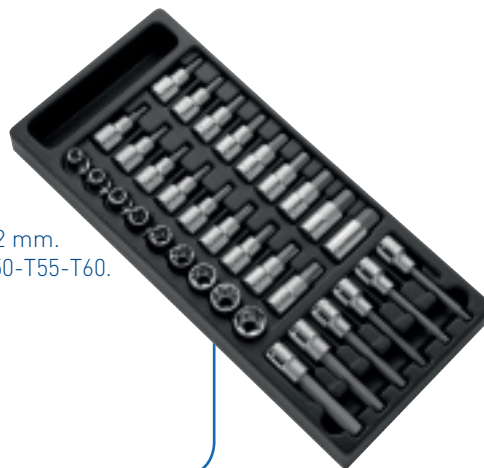

MÓDULO DE CHAVES DE CAIXA E ACESSÓRIOS 1/2" MÉTRICAS - 21 PEÇAS

- Chaves de caixa 1/2" 6 faces: 8-10-11-12-13-14-15-16-17-18-19-21-22-23-24-27-30-32 mm.
- 1 roquete parquímetro de bloqueio 1/2".
- 1 extensão 1/2": 250 mm.
- 1 cardan 1/2".
- Tabuleiro vazio: E032901.



E194677	1/2"	Qde	Peso kg	☒	EAN
E194677	1/2"	21	3,5	1	3258951946770



MÓDULO DE CHAVES DE CAIXA LONGAS 1/2" MÉTRICAS - 10 PEÇAS

- Chaves de caixa longas 1/2" sextavadas: 10 mm.
- Chaves de caixa longas 1/2" 12 faces: 12-13-14-17-19-21-22-23-24 mm.
- Tabuleiro vazio: E010515.



E032201	1/2"	Qde	Peso g	☒	EAN
E032201	1/2"	10	1968	1	3258950322018



MÓDULO DE ACESSÓRIOS 1/2" MÉTRICOS - 8 PEÇAS

- 3 extensões 1/2": 75-130-250 mm.
- 1 roquete cabeça articulada 1/2".
- 1 cabo T correção 1/2".
- 1 chave de caixa 1/2" porta-pontas 5/16".
- 1 redutor de 1/2" - 3/8".
- 1 aumento 1/2" - 3/4".
- Tabuleiro vazio: E032925.

E032924	1/2"	Qde	Peso g	☒	EAN
E032924	1/2"	8	2150	1	3258950328010





COMPOSIÇÕES DE CHAVES DE CAIXA 1/2"

CAIXA DE CHAVES DE CAIXA 1/2" - 36 PEÇAS

- Chaves de caixa 1/2" 6 faces: 8-9-10-11-12-13-14-15-16-17-18-19-21-24-27-28-30-32-34 mm.
- Chaves de caixa sextavadas: 5-6-10-12-14 mm.
- Chaves de bocas métricas: 6x7 - 8x9 - 10x11 - 12x13 - 14x15 - 16x17 - 18x19 mm.
- 1 roquete parquímetro de bloqueio 1/2".
- 2 extensões 1/2": 130-250 mm.
- 1 pega corrediça 1/2".
- 1 cardan 1/2".



E032940	1/2"	Qde	Peso kg	☒	EAN
		36	6,1	1	3258950329406



CAIXA DE CHAVES DE CAIXA 1/2" - 28 PEÇAS

- Chaves de caixa 1/2" 6 faces: 8-9-10-11-12-13-14-15-16-17-18-19-20-21-22-23-24-25-26-27-28-30-32-34 mm.
- 1 roquete parquímetro de bloqueio 1/2".
- 1 pega corrediça 1/2".
- 1 cardan 1/2".
- 1 extensão 1/2": 250 mm.



E032939	1/2"	Qde	Peso kg	☒	EAN
		28	5,3	1	3258950329390



CAIXA DE CHAVES DE CAIXA 1/2" - 26 PEÇAS

- Chaves de caixa 1/2" 6 faces: 10-11-12-13-14-15-16-17-18-19-20-21-22-23-24-27-28-30-34 mm.
- 1 roquete cabeça redonda 1/2".
- 2 extensões 1/2": 130-250 mm.
- 1 pega corrediça 1/2".
- 1 cardan 1/2".
- 1 cambota 1/2".
- 1 chave de caixa para velas 1/2".



E032943	1/2"	Qde	Peso kg	☒	EAN
		26	6	1	3258950329437





CAIXA DE CHAVES DE CAIXA 1/2" - 25 PEÇAS

- Chaves de caixa 1/2" 6 faces: 8-9-10-11-12-13-14-16-17-18-19-21-24-27-30-32 mm.
- Chaves de bocas métricas: 6x7 - 8x9 - 10x11 - 12x13 - 14x15 - 16x17 - 18x19 mm.
- 1 roquete cabeça redonda 1/2".
- 1 extensão 1/2": 130 mm.



E032937	1/2"	Qde	Peso kg	1	EAN
E032937	1/2"	25	3,9	1	3258950329376



CAIXA DE CHAVES DE CAIXA 1/2" - 14 PEÇAS

- Chaves de caixa 1/2" 6 faces: 10-11-12-13-16-18-21-24-27-30-34 mm.
- 1 roquete cabeça redonda 1/2".
- 1 extensão 1/2": 250 mm.
- 1 pega corrediça 1/2".



E032938	1/2"	Qde	Peso kg	1	EAN
E032938	1/2"	14	3,1	1	3258950329383



JOGO DE CHAVES DE CAIXA EM EXPOSITOR 1/2" - 18 PEÇAS

- Chaves de caixa 1/2" 6 faces: 8-9-10-11-12-13-14-15-16-17-18-19-20-21-22-23 mm.
- 1 roquete parquímetro de bloqueio 1/2".
- 1 extensão 1/2": 130 mm.
- Entregue em expositor.

E032942	1/2"	Qde	Peso kg	1	EAN
E032942	1/2"	18	1,8	1	3258950329420





ROQUETES 1/2"

ROQUETE DE CABEÇA REDONDA 1/2"

- ISO 3315 - DIN 3122 - ISO 1174-1
- Mecanismo 72 dentes.
- Ângulo de retoma 5°.
- Cabeça compacta.
- Acabamento: crómio pólido.
- Cabo em bi-matéria ergonómico.

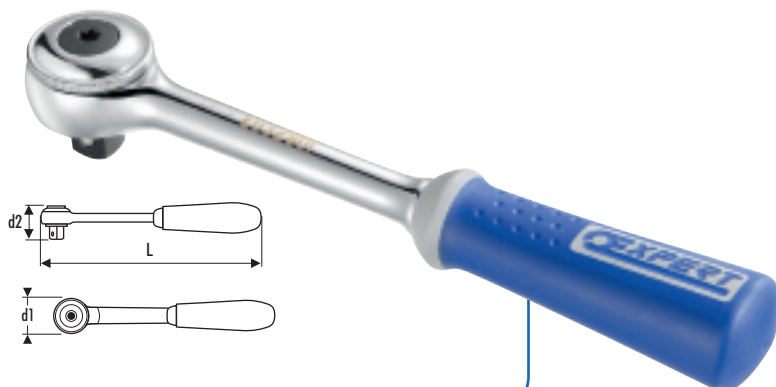

E032801	d1 mm	d2 mm	L mm	Peso g	☒	EAN
E032801	42.4	42	250	490	1	3258950328010

ROQUETE COM BLOQUEIO 1/2"

- ISO 3315 - DIN 3122 - ISO 1174-1
- Mecanismo 72 dentes.
- Ângulo de retoma 5°.
- Bloqueio de segurança da chave de caixa.
- Inversão por alavanca: visualização do sentido de rotação.
- Acabamento: crómio pólido.
- Cabo em bi-matéria ergonómico.



E032808	d1 mm	d2 mm	L mm	Peso g	☒	EAN
E032808	38	36.8	250	528	1	3258950328009

ROQUETE COM BLOQUEIO - 1/2" CABO EM METAL

- ISO 3315 - DIN 3122 - ISO 1174-1
- Mecanismo 72 dentes.
- Ângulo de retoma de 5°.
- Bloqueio de segurança da chave de caixa.
- Inversão por alavanca: visualização do sentido de rotação.
- Acabamento: crómio pólido.

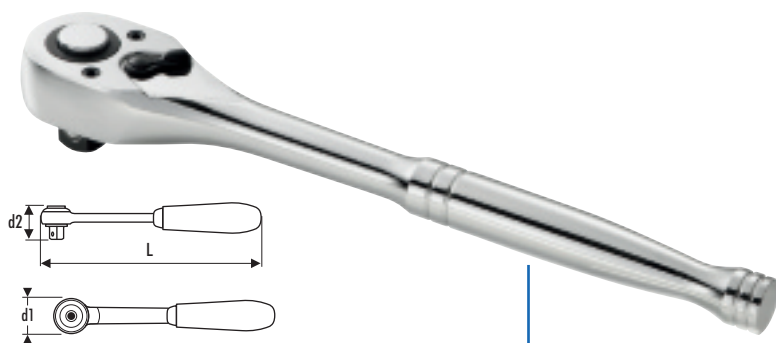

E032709	d1 mm	d2 mm	L mm	Peso g	☒	EAN
E032709	39,2	39	250	588	1	3258950327099



ROQUETE ARTICULADO 1/2"

- ISO 3315 - DIN 3122 - ISO 1174-1
- Mecanismo 72 dentes.
- Ângulo de curvatura 5°.
- Cabo articulado para uma acessibilidade acrescida.
- Cabo de grande comprimento para um desaperto mais potente.
- Bloqueio de segurança da chave de caixa.
- Inversão por alavanca: visualização do sentido de rotação.
- Acabamento: crómio pólido.
- Cabo em bi-matéria ergonómico.

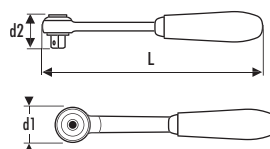

	d1 mm	d2 mm	L mm	Peso g	☒	EAN
E032803	40	40	437	930	1	3258950328034

ROQUETE DE CABEÇA ARTICULADA 1/2"

- ISO 3315 - DIN 3122 - ISO 1174-1
- Mecanismo 72 dentes.
- Ângulo de curvatura 5°.
- Cabeça compacta.
- Acabamento: crómio pólido.
- Cabo em bi-matéria ergonómico.

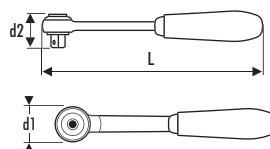
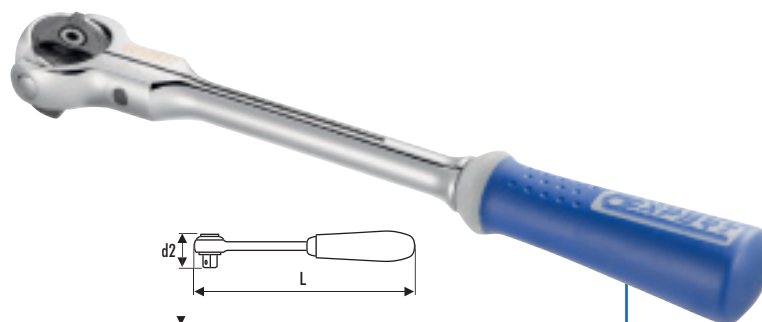

	d1 mm	d2 mm	L mm	Peso g	☒	EAN
E032802	49,1	39,2	306	640	1	3258950328027

RABO DE FORÇA ARTICULADO 1/2"

- ISO 3315 - DIN 3122 - ISO 1174-1
- Articulação travada.
- Cabo articulado para uma acessibilidade acrescida.
- Acabamento: crómio pólido.
- Cabo em bi-matéria ergonómico.



	L mm	Peso g	☒	EAN
E032701	300	560	1	3258950327013
E032804	450	860	1	3258950328041
E032805	600	1120	1	3258950328058





ACESSÓRIOS 1/2"

MANIVELA 1/2"

- ISO 3315 - DIN 3122 - ISO 1174-1
- Grande rapidez de manobra.
- Punho giratório.



E032702	L mm	Peso g	☒	EAN
E032702	425	510	1	3258950327020

PEGA CURVA 1/2"

- ISO 1174 - DIN 3122
- Acabamento: crómio mate.

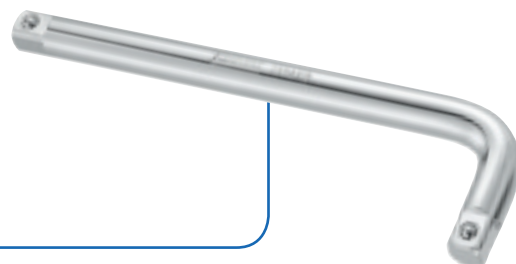

E032713	L mm	Peso g	☒	EAN
E032713	200	280	1	3258950327136

PEGA CURVA COM CABO 1/2"

- ISO 1174 - DIN 3122
- Pega de dupla matéria ergonómica.
- Acabamento: crómio mate.

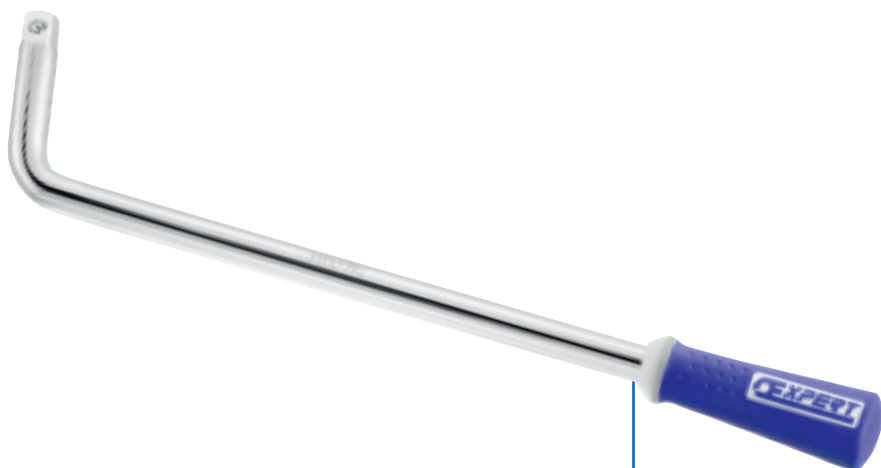

E032714	L mm	Peso g	☒	EAN
E032714	400	691	1	3258950327143



CABO T CORREDIÇO - 1/2"

- ISO 3315 - DIN 3122 - ISO 1174-1
- Cabeça corrediça.
- Aço de crómio vanádio.
- Para uma utilização manual.

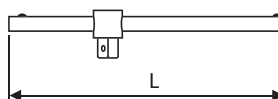
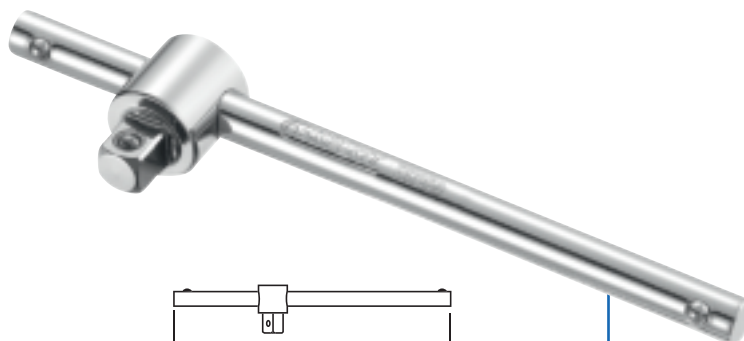

	L mm	Peso g	☒	EAN
E117259	240	316	1	3258951172599

EXTENSÕES 1/2"

- ISO 3315 - DIN 3122 - ISO 1174-1
- Aço de crómio-vanádio.
- Acabamento: crómio póliado.
- Para uma utilização manual.

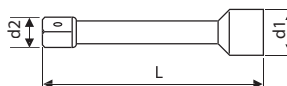
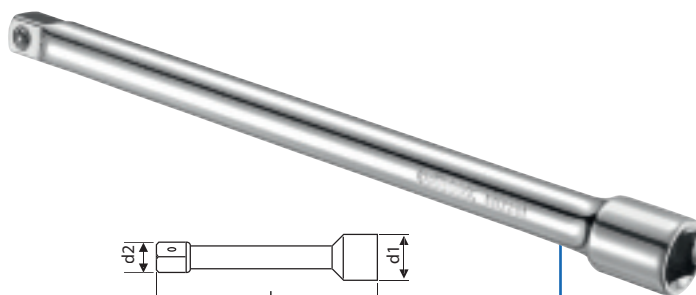

	d1 mm	d2 mm	L mm	Peso g	☒	EAN
E113710	22.5	12.7	75	125	1	3258951137109
E117260	22.5	12.7	130	220	1	3258951172605
E117261	22.5	12.7	250	405	1	3258951172612

EXTENSÃO FLEXÍVEL 1/2" - 200 MM

- Ideal para o aperto e desaperto em espaços restritos.
- Corpo flexível.
- Utilização manual (sem ferramentas energizadas).



	Peso g	☒	EAN
E032711	212	1	3258950327112





ACESSÓRIOS 1/2"

CHAVE DE CAIXA 1/2" PORTA-PONTEIRA 5/16"

- ISO 1173 - DIN 3126 - ISO 1174-1
- Para uma utilização manual.
- Acabamento: crómio pólido.
- Aço de crómio-vanádio.

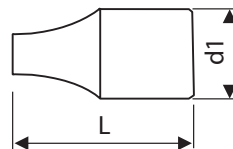

	d1 mm	d2 mm	L mm	Peso g		EAN
E113711	25	12.7	40	90	5	3258951137116

REDUTOR 1/2" - 3/8"

- ISO 3316 - DIN 3123 - ISO 1174-1
- Aço de crómio vanádio.
- Acabamento: crómio pólido.
- Para uma utilização manual.

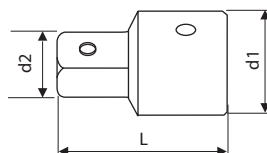

	d1 mm	d2 mm	L mm	Peso g		EAN
E117262	22	12.7	34,5	46	1	3258951172629

AUMENTADOR 1/2" - 3/4"

- ISO 3316 - DIN 3123 - ISO 1174-1
- Aço de crómio vanádio.
- Acabamento: crómio pólido.
- Para uma utilização manual.

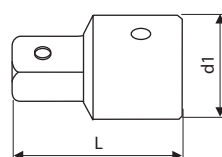

	d1 mm	d2 mm	L mm	Peso g		EAN
E117263	25.2	12.7	42	75	5	3258951172636

ADAPTADOR MAGNÉTICO 1/2" - 3/4"

- Utilização apenas com ferramentas manuais.
- Magnetizado.
- Entregue em expositor metálico.



		L mm	Peso g		EAN
E041507	1/2" - 3/4"	25,5	74	1	3258950415079



CARDAN 1/2"

- ISO 3316 - DIN 3123 - ISO 1174-1
- Aço de cromo vanádio.
- Acabamento: cromo pólido.
- Para uma utilização manual.

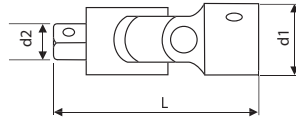

	d1 mm	d2 mm	L mm	Peso g	☒	EAN
E117264	24,9	12,7	40,5	140	1	3258951172643



CHAVES DE CAIXA 1/2"

CHAVES DE CAIXA 1/2" - SEXTAVADAS - MÉTRICAS

- ISO 2725-1 - DIN 3124 - ISO 1174-1 - ISO 1711-1 - ISO 691
- Aço de cromo vanádio.
- Perfil Maxi Drive: transmissão do binário de aperto nos flancos da porca e não nas arestas.
- Acabamento cromo brilhante.
- Para uma utilização manual.

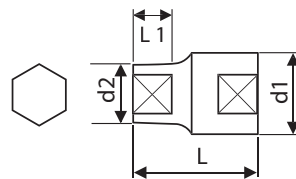

	A mm	d1 mm	d2 mm	L mm	L1 mm	Peso g	☒	EAN
E117086	8	21,8	12,4	38	9	45	1	3258951170861
E117087	9	21,8	14	38	10	45	1	3258951170878
E117088	10	21,8	15,5	38	10	48	1	3258951170885
E117089	11	21,8	16,7	38	11	50	1	3258951170892
E117090	12	21,8	18	38	10	50	1	3258951170908
E117091	13	21,8	19,2	38	10	52	1	3258951170915
E117092	14	21,8	20,5	38	10	54	1	3258951170922
E117093	15	21,8	21	38	14	54	1	3258951170939
E117094	16	23,3	22,5	38	14	66	1	3258951170946
E117095	17	24	24	38	14	76	1	3258951170953
E117096	18	24,8	24,8	38	14	84	1	3258951170960
E117097	19	26,3	26,3	38	16,7	84	1	3258951170977
E117098	20	26,8	26,8	38	17,3	84	1	3258951170984
E117099	21	27,7	27,7	38	18	92	1	3258951170991
E117250	22	29,8	29,8	40	18	118	1	3258951172506
E117251	23	30,8	30,8	40	18	125	1	3258951172513
E117252	24	31,8	31,8	40	18	134	1	3258951172520
E031937	25	32,8	32,8	41	20	142	1	3258950319377
E117253	26	33,8	33,8	41	20	160	1	3258951172537
E117254	27	35,8	35,8	41	20	192	1	3258951172544
E117255	28	37,6	37,6	41	20	220	1	3258951172551
E117256	29	37,8	37,8	41	20	210	1	3258951172568
E117257	30	39,8	39,8	41	20	234	1	3258951172575
E117258	32	41,8	41,8	41	20	266	1	3258951172582
E031936	34	43,8	43,8	45,50	25	300	1	3258950319360
E031938	36	49,8	49,8	57,20	27	462	1	3258950319384





CHAVES DE CAIXA 1/2"

CHAVES DE CAIXA 1/2" MÉTRICAS - SEXTAVADAS

- ISO 2725-1 - DIN 3124 - ISO 1174-1 - ISO 1711-1 - ISO 691
- Aço de cromo-vanádio.
- Perfil Maxi Drive: transmissão do binário de aperto nos flancos da porca e não nas arestas.
- Acabamento: cromo pólido.
- Para uma utilização manual.

	A mm	d1 mm	d2 mm	L mm	L1 mm	Peso g	☒	EAN
E117051	8	21.8	12.4	38	9	45	1	3258951170519
E117052	9	21.8	14	38	10	45	1	3258951170526
E117053	10	21.8	15.5	38	10	18	1	3258951170533
E117054	11	21.8	16.7	38	10	50	1	3258951170540
E117055	12	21.8	18	38	10	50	1	3258951170557
E117056	13	21.8	19.2	38	10	52	1	3258951170564
E117057	14	21.8	20.5	38	10	54	1	3258951170571
E117058	15	21.8	21	38	14	54	1	3258951170588
E117059	16	23.3	22.5	38	14	66	1	3258951170595
E117060	17	24	24	38	14	76	1	3258951170601
E117061	18	24.8	24.8	38	14	84	1	3258951170618
E117062	19	26.3	26.3	38	16.7	84	1	3258951170625
E117063	20	26.8	26.8	38	17.3	84	1	3258951170632
E117064	21	27.7	27.7	38	18	92	1	3258951170649
E117065	22	29.8	29.8	40	18	118	1	3258951170656
E117066	23	30.8	30.8	40	18	125	1	3258951170663
E117067	24	31.8	31.8	40	18	134	1	3258951170670
E117068	26	33.8	33.8	41	20	160	1	3258951170687
E117069	27	35.8	35.8	41	20	192	1	3258951170694
E117070	28	37.6	37.6	41	20	210	1	3258951170700
E117071	29	37.8	37.8	41	20	210	1	3258951170717
E117072	30	39.8	39.8	41	20	234	1	3258951170724
E117073	32	41.8	41.8	41	20	266	1	3258951170731
E032001	36	49.8	49.8	57,20	27	462	1	3258950320014

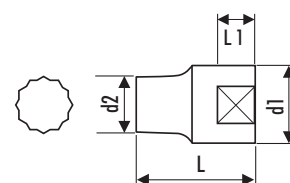

CHAVES DE CAIXA 1/2" POLEGADAS - 12 FACES

- ASME B 107-1 - ISO 1174-1
- Aço de cromo-vanádio.
- Perfil Maxi Drive: transmissão do binário de aperto nos flancos da porca e não nas arestas.
- Acabamento: cromo pólido.
- Para uma utilização manual.

	A "	d1 mm	d2 mm	L mm	L1 mm	Peso g	☒	EAN
E113701	3/8"	21.8	14.7	38	9	45	1	3258951137017
E113702	7/16"	21.8	17	38	9	45	1	3258951137024
E113703	1/2"	21.8	19	38	10	48	1	3258951137031
E117074	9/16"	21.8	20.8	38	12.5	55	1	3258951170748
E117075	19/32"	21.8	20.8	38	14.3	55	1	3258951170755
E117076	5/8"	23.3	22.5	38	14.3	68	1	3258951170762
E113704	21/32"	23.3	23.3	38	14.3	68	1	3258951137048
E117077	11/16"	24.2	24.2	38	14.3	74	1	3258951170779
E117078	3/4"	26.3	26.3	38	18	87	1	3258951170786
E113705	25/32"	26.8	26.8	38	18	86	1	3258951137055
E117079	13/16"	27.7	27.7	38	18	92	1	3258951170793
E117080	7/8"	29.8	29.8	38	18	117	1	3258951170809
E117081	15/16"	31.8	31.8	38	18	136	1	3258951170816
E113706	31/32"	32.8	32.8	38	18	140	1	3258951137062
E117082	1"	33.8	33.8	41	18	148	1	3258951170823
E117083	1"1/16	35.8	35.8	41	20	190	1	3258951170830
E117084	1"1/8	37	37	41	20	228	1	3258951170847
E113707	1"3/16	39.8	39.8	41	20	230	1	3258951137079
E117085	1"1/4	41.8	41.8	41	20	268	1	3258951170854

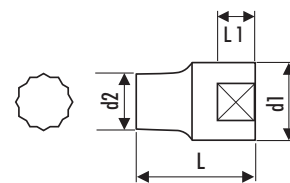



CHAVES DE CAIXA LONGAS 1/2" MÉTRICAS - SEXTAVADAS

- Aço de cromo-vanádio.
- Perfil Maxi Drive: transmissão do binário de aperto nos flancos da porca e não nas arestas.
- Acabamento: cromo pólido.
- Para uma utilização manual.

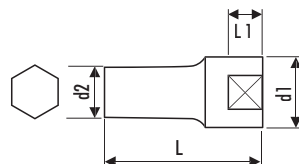

	A mm	d1 mm	d2 mm	L mm	L1 mm	Peso g	☒	EAN
E032103	10	22	15.5	79	17	98	1	3258950321035
E117265	12	22	18	79	19	105	1	3258951172650
E117266	13	22	19.2	79	21	115	1	3258951172667
E117267	14	22	20.5	79	25	120	1	3258951172674
E117268	15	22	21	79	28	125	1	3258951172681
E117269	16	23.3	22.5	79	31	128	1	3258951172698
E117270	17	24	24	79	34	140	1	3258951172704
E117271	18	25.3	25.3	79	34	160	1	3258951172711
E117272	19	26.5	26.5	79	36	160	1	3258951172728
E117273	21	27.8	27.8	79	36	200	1	3258951172735
E117274	22	29.8	29.8	79	36	215	1	3258951172742
E117275	24	31.8	31.8	79	36	255	1	3258951172759
E117276	27	35.8	35.8	79	36	310	1	3258951172766
E117277	30	39.8	39.8	79	36	355	1	3258951172773

CHAVES DE CAIXA LONGAS 1/2" MÉTRICAS - 12 FACES

- ISO 2725-1 - DIN 3124 - ISO 1174-1 - ISO 1711-1 - ISO 691
- Aço de cromo-vanádio.
- Perfil Maxi Drive: transmissão do binário de aperto nos flancos da porca e não nas arestas.
- Acabamento: cromo pólido.
- Para uma utilização manual.

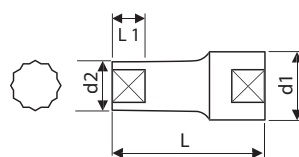

	A mm	d1 mm	d2 mm	L mm	L1 mm	Peso g	☒	EAN
E032203	10	22	15.5	79	17	98	1	3258950322032
E117278	12	22	18	79	19	105	1	3258951172780
E117279	13	22	19.2	79	21	115	1	3258951172797
E117280	14	22	20.5	79	25	120	1	3258951172803
E117281	15	22	21	79	28	125	1	3258951172810
E117282	16	23.3	22.5	79	31	128	1	3258951172827
E117283	17	24	24	79	34	140	1	3258951172834
E117284	18	25.3	25.3	79	34	160	1	3258951172841
E117285	19	26.5	26.5	79	36	160	1	3258951172858
E117286	21	27.8	27.8	79	36	200	1	3258951172865
E117287	22	29.8	29.8	79	36	215	1	3258951172872
E117288	23	30.8	30.8	79	36	232	1	3258951172889
E117289	24	31.8	31.8	79	36	255	1	3258951172896
E117290	27	35.8	35.8	79	36	310	1	3258951172902
E117291	30	39.8	39.8	79	36	355	1	3258951172919
E117292	32	41.3	41.3	79	36	408	1	3258951172926





CHAVES DE CAIXA 1/2"

CHAVES DE CAIXA LONGAS 1/2" POLEGADAS - 12 FACES

- ASME B 107-1 - ISO 1174-1
- Aço de cromo-vanádio.
- Perfil Maxi Drive: transmissão do binário de aperto nos flancos da porca e não nas arestas.
- Acabamento: cromo pólido.
- Para uma utilização manual.

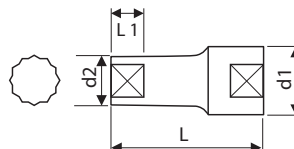

	A"	d1 mm	d2 mm	L mm	L1 mm	Peso g	☒	EAN
E113713	1/2"	22	19	79	20	116	1	3258951137130
E113714	9/16"	22	20.8	79	22	118	1	3258951137147
E113715	5/8"	23.3	22.5	79	24	126	1	3258951137154
E113716	11/16"	24	24	79	26	146	1	3258951137161
E113717	3/4"	26	26	79	29	180	1	3258951137178
E113718	13/16"	27	27	79	31	240	1	3258951137185
E113719	1/8"	29	29	79	31	250	1	3258951137192
E113720	15/16"	31	31	79	33	265	1	3258951137208
E113721	1"	33	33	79	33	290	1	3258951137215
E113722	1 1/16"	35	35	79	33	315	1	3258951137222
E113723	1 1/8"	37	37	79	33	350	1	3258951137239
E113724	1 1/4"	41	41	79	33	360	1	3258951137246

CHAVES DE CAIXA TORX® 1/2"

CHAVES DE CAIXA TORX® 1/2"

- ISO 1174-1
- Para parafusos macho Torx®.
- Aço com cromo-vanádio.
- Acabamento: cromo brilhante.

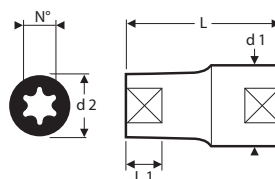

	N°	d1 mm	d2 mm	L mm	L1 mm	Peso g	☒	EAN
E031984	E8	21,8	11	38	12,7	49	1	3258950319841
E031927	E10	21,8	13,3	38	10	41	1	3258950319278
E031935	E11	21,8	14	38	11	41	1	3258950319353
E031928	E12	21,8	15	38	12	47	1	3258950319285
E031929	E14	21,8	17	38	12	47	1	3258950319292
E031930	E16	21,8	18,5	38	12	57	1	3258950319308
E031931	E18	21,8	20	38	12	57	1	3258950319315
E031932	E20	23,3	23,3	38	13	63	1	3258950319322
E031933	E22	24,8	24,8	38	15	80	1	3258950319339
E031934	E24	26,8	26,8	38	16	97	1	3258950319346



CHAVES DE CAIXA APARAFUSADORAS 1/2"

CHAVES DE CAIXA 1/2" PARA PARAFUSOS SEXTAVADOS INTERIORES

- ISO 2725-1 - DIN3124 - ISO 1174-1
- Aço de cromo vanádio.
- Acabamento: cromo pólido.

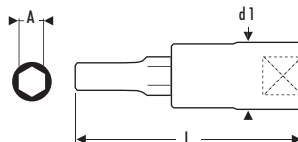

	A mm	d1 mm	L mm	Peso g	☒	EAN
E031901	4	22	55	59	1	3258950319018
E031902	5	22	55	60	1	3258950319025
E031903	6	22	55	62	1	3258950319032
E031904	7	22	55	64	1	3258950319049
E031905	8	22	55	65	1	3258950319056
E031906	9	22	55	72	1	3258950319063
E031907	10	22	55	80	1	3258950319070
E031908	12	22	55	102	1	3258950319087
E031909	14	22	55	127	1	3258950319094
E031910	17	22	55	152	1	3258950319100
E031911	19	22	55	201	1	3258950319117

CHAVES DE CAIXA 1/2" PONTAS LONGAS PARA PARAFUSOS SEXTAVADOS INTERIORES

- ISO 2725-1 - DIN3124 - ISO 1174-1
- Aço com cromo-vanádio.
- Acabamento: cromo brilhante.

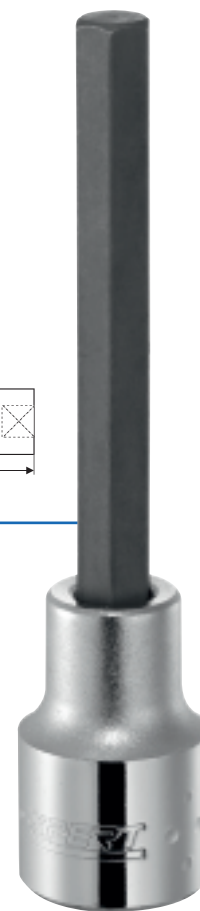
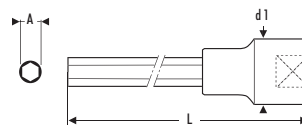

	A mm	d1 mm	L mm	Peso g	☒	EAN
E031912	4	22	100	69	1	3258950319124
E031913	5	22	100	71	1	3258950319131
E031914	6	22	100	77	1	3258950319148
E031982	7	22	100	75	1	3258950319827
E031915	8	22	100	79	1	3258950319155
E031916	10	22	100	132	1	3258950319162
E031917	12	22	100	144	1	3258950319179
E031983	14	22	100	153	1	3258950319834

CHAVES DE CAIXA 1/2" PARA PARAFUSOS TORX® INTERIORES

- ISO 1174-1
- Aço de cromo vanádio.
- Acabamento: cromo pólido.

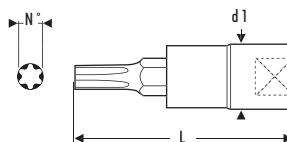

	N°	d1 mm	L mm	Peso g	☒	EAN
E031918	T20	22	55	58	1	3258950319186
E031919	T25	22	55	58	1	3258950319193
E031920	T27	22	55	59	1	3258950319209
E031921	T30	22	55	59	1	3258950319216
E031922	T40	22	55	62	1	3258950319223
E031923	T45	22	55	63	1	3258950319230
E031924	T50	22	55	74	1	3258950319247
E031925	T55	22	55	96	1	3258950319254
E031926	T60	22	55	117	1	3258950319261





CHAVES DE CAIXA 1/2" LONGAS

CHAVES DE CAIXA 1/2" PONTA LONGA PARA PARAFUSOS TORX®

- ISO 1174 - ISO3120.
- Aço de cromo vanádio.
- Acabamento: cromo brilhante.

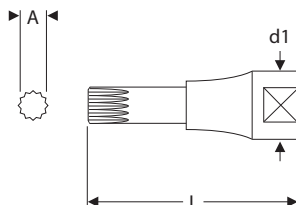

	A mm	d1 mm	L mm	Peso g	☐	EAN
E031978	T40	22	120	93	1	3258950319780
E031980	T45	22	120	94	1	3258950319797
E031981	T50	22	120	102	1	3258950319803
E031979	T55	22	120	127	1	3258950319810



CHAVES DE CAIXA 1/2" PARA PARAFUSOS XZN®

- ISO 1174 - ISO3120.
- Aço de cromo vanádio.
- Acabamento: cromo brilhante.

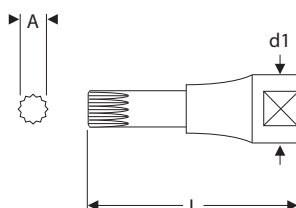

	A mm	d1 mm	L mm	Peso g	☐	EAN
E031967	M5	22	55	52	1	3258950319674
E031968	M6	22	55	56	1	3258950319681
E031969	M8	22	55	59	1	3258950319698
E031970	M10	22	55	70	1	3258950319704
E031971	M12	22	55	77	1	3258950319711
E031972	M14	22	55	91	1	3258950319728
E031973	M16	22	55	98	1	3258950319735



CHAVES DE CAIXA 1/2" PONTA LONGA PARA PARAFUSOS XZN®

- ISO 1174 - ISO3120.
- Aço de cromo vanádio.
- Acabamento: cromo brilhante.

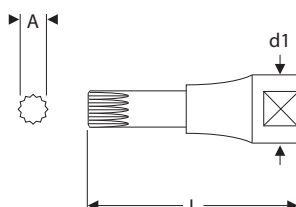

	A mm	d1 mm	L mm	Peso g	☐	EAN
E031974	M8	24	120	126	1	3258950319742
E031975	M10	24	120	128	1	3258950319759
E031976	M12	24	120	159	1	3258950319766
E031977	M14	24	120	191	1	3258950319773





COMPOSIÇÕES DE CHAVES DE CAIXA 3/4"

CAIXA DE CHAVES DE CAIXA 3/4" - 14 PEÇAS

- Chaves de caixa 3/4" sextavadas: 22-24-27-30-32-34-36-41-46-50 mm.
- 1 cabo T correção 3/4".
- 1 roquete 3/4".
- 2 extensões 3/4": 200-400 mm.
- Fornecido em caixa metálica.



E194682	3/4"	Qde	Dimensões	Peso kg	☒	EAN
		14	L.539xP.133xH.80 mm	14	1	3258951946824

CHAVES DE CAIXA 3/4" SEXTAVADAS - MÉTRICAS

- Chaves de caixa 3/4" sextavadas: 19-21-22-24-27-30-32-34-36-41-46-50-55 mm.
- 2 extensões 3/4": 200-400 mm.
- 1 cabo T correção 3/4".
- 1 roquete 3/4".
- 1 cardan 3/4".
- Fornecido em caixa metálica.



E194683	3/4"	Qde	Dimensões	Peso kg	☒	EAN
		18	L.539xP.133xH.80 mm	15,5	1	3258951946831

ROQUETES 3/4"

ROQUETE COM CABO 3/4"

- ISO 3315 - DIN 3122 - ISO 1174-1
- Equipado com um bloqueio de segurança com chaves de caixa e acessórios.
- Mecanismo 24 dentes.
- Ângulo de retoma 15°.
- Aço cromo-vanádio.
- Acabamento: cromo mate.
- Fornecido com cabo trancável na cabeça do roquete.

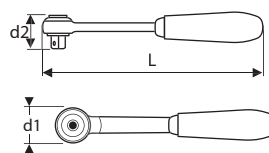

E113819	d1 mm	d2 mm	L mm	Peso kg	☒	EAN
	63.4	59	568	2,37	1	3258951138199





ROQUETES 3/4"

ROQUETE 3/4"

- ISO 3315 - DIN 3122 - ISO 1174-1
- Equipado com um bloqueio de segurança com chaves de caixa e acessórios.
- Mecanismo 24 dentes.
- Ângulo de retoma 15°.
- Acabamento: crómio mate.
- Aço crómio-vanádio.
- Fornecido sem cabo.

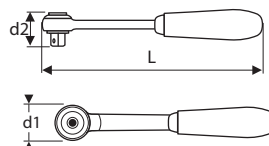

E113817	d1 mm	d2 mm	L mm	Peso kg		EAN
E113817	63.4	59	155	1,24	1	3258951138175

CABO PARA ROQUETE 3/4"

- ISO 3315 - DIN 3122 - ISO 1174-1
- Acabamento: crómio mate.
- Para uma utilização manual.
- Aço crómio-vanádio.

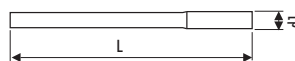
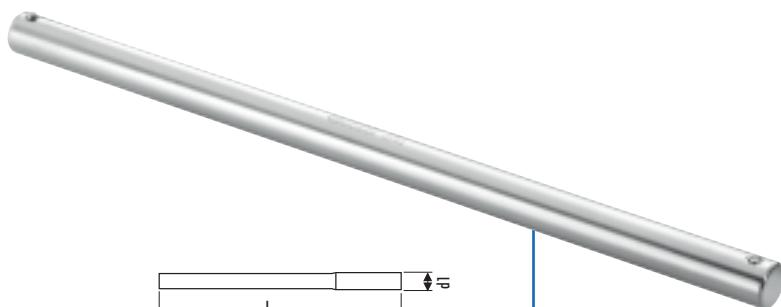

E113816	d1 mm	L mm	Peso kg		EAN
E113816	20	455	1,13	1	3258951138168

ACESSÓRIOS 3/4"

CABO T CORREDIÇÃO 3/4"

- ISO 3315 - DIN 3122 - ISO 1174-1
- Alta resistência ao binário.
- Aço de crómio vanádio.
- Acabamento: crómio mate.
- Para uma utilização manual.
- Equipado com um bloqueio de segurança com chaves de caixa e acessórios.

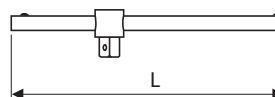

E113815	L mm	Peso kg		EAN
E113815	455	1,30	1	3258951138151



PUNHO ARTICULADO 3/4"

- ISO 3315 - DIN 3122 - ISO 1174-1
- Alta resistência ao binário.
- Aço de crómio vanádio.
- Acabamento: crómio mate.
- Para uma utilização manual.
- Cabo metálico.

	L mm	Peso kg	☒	EAN
E033804	1250	3,70	1	3258950338040

EXTENSÕES 3/4"

- ISO 3316 - DIN 3123 - ISO 1174-1
- Acabamento: crómio mate.
- Aço crómio-vanádio.
- Para utilização manual.

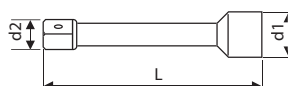
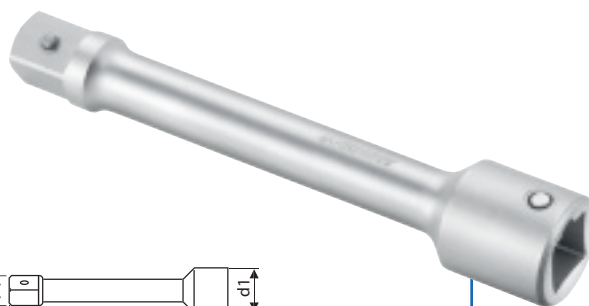

	d1 mm	d2 mm	L mm	Peso g	☒	EAN
E113820	35.5	25	100	410	1	3258951138205
E113823	35.5	25	400	1130	1	3258951138236
E113824	35.5	25	200	620	1	3258951138243

REDUTOR 3/4" - 1/2"

- ISO 3316 - DIN 3123 - ISO 1174-1
- Bloqueio de segurança.
- Acabamento: crómio mate.
- Para uma utilização manual.

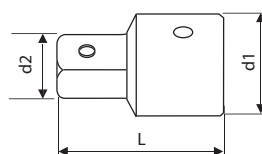

	d1 mm	d2 mm	L mm	Peso g	☒	EAN
E113821	34	12.58	48	166	1	3258951138212





ACESSÓRIOS 3/4"

AUMENTADOR 3/4" - 1"

- ISO 3316 - DIN 3123 - ISO 1174-1
- Acabamento: crómio mate.
- Fixação de segurança.
- Aço crómio vanádio.
- Para uma utilização manual.

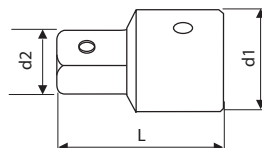

	d1 mm	d2 mm	L mm	Peso g		EAN
E033802	38	33.5	62	340	1	3258950338026

CARDAN 3/4"

- ISO 3316 - DIN 3123 - ISO 1174-1
- Acabamento: crómio mate.
- Bloqueio de segurança.
- Acabamento: crómio mate.
- Para uma utilização manual.

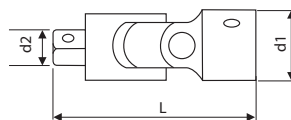

	d1 mm	d2 mm	L mm	Peso g		EAN
E113822	40	25	107	550	1	3258951138229

CARDAN 3/4" PARA BARRA

- ISO 3316 - DIN 3123 - ISO 1174-1
- Aço crómio-vanádio.
- Acabamento: crómio mate.
- Utilização com cabo E113816.
- Bloqueio de segurança.
- Para uma utilização manual.

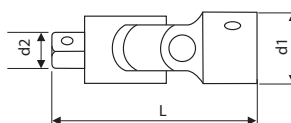

	d1 mm	d2 mm	L mm	Peso g		EAN
E033801	36	25	138	550	1	3258950338019



CHAVES DE CAIXA 3/4"

CHAVES DE CAIXA 3/4" - SEXTAVADAS - MÉTRICAS

- ISO 2725-1 - DIN 3124 - ISO 1174-1 - ISO 1711-1 - ISO 691
- Fixação de segurança.
- Aço crómio vanádio.
- Acabamento: crómio mate.
- Para uma utilização manual.

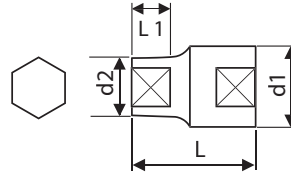

	A mm	d1 mm	d2 mm	L mm	L1 mm	Peso g	☒	EAN
E113790	19	33	27.2	50	14	207	1	3258951137901
E113791	21	33	31.2	50	16.5	208	1	3258951137918
E113792	22	36	32.2	50	16.5	221	1	3258951137925
E113793	23	36	33.2	50	16.5	244	1	3258951137932
E113794	24	36	34.2	51	16.5	237	1	3258951137949
E113795	26	36	37	52	22	231	1	3258951137956
E113796	27	36	38	52	22	232	1	3258951137963
E113797	28	36	39.5	52	22	239	1	3258951137970
E113798	29	36	40.5	52	24	245	1	3258951137987
E113799	30	36	42	54	24	282	1	3258951137994
E113800	32	36	44	56	24	301	1	3258951138007
E113801	33	36	46	56	26	330	1	3258951138014
E113802	34	36	47	56	26	322	1	3258951138021
E113803	35	38	48	58	26	344	1	3258951138038
E113804	36	38	50	58	28	347	1	3258951138045
E113805	38	38	52	60	28	478	1	3258951138052
E113806	40	40	54	62	30	493	1	3258951138069
E113807	41	40	56	64	30	504	1	3258951138076
E113808	42	40	57	64	30	552	1	3258951138083
E113809	44	40	60	66	32	587	1	3258951138090
E113810	46	42	62	66	32	641	1	3258951138106
E113811	50	42	68	70	34	725	1	3258951138113
E113812	54	45	72	72	36	880	1	3258951138120
E113813	55	45	75	75	36	875	1	3258951138137



CHAVES DE CAIXA 3/4" 12 FACES - POLEGADAS

- ASME B 107-1 - ISO 1174-1
- Bloqueio de segurança.
- Botão de desbloqueio rápido.
- Aço crómio-vanádio
- Acabamento: crómio mate.
- Para uma utilização manual.

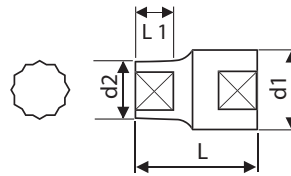

	A"	d1 mm	d2 mm	L mm	L1 mm	Peso g	☒	EAN
E033503	7/8"	33	31.2	50	14	210	1	3258950335032
E033504	15/16"	36.2	34.2	51	16.5	220	1	3258950335049
E033505	1"	36	37	52	16.5	220	1	3258950335056
E033506	1"1/16	36	38	52	22	220	1	3258950335063
E033507	1"1/8	36	40	52	22	250	1	3258950335070
E033508	1"3/16	36	42	54	24	260	1	3258950335087
E033509	1"1/4	36	44	56	24	270	1	3258950335094
E033510	1"5/16	36	46	56	26	300	1	3258950335100
E033511	1"3/8	38	48	58	26	340	1	3258950335117
E033512	1"7/16	38	50	58	28	350	1	3258950335124
E033513	1"1/2	38	52	60	28	390	1	3258950335131
E033514	1"5/8	40	56	64	30	480	1	3258950335148
E033515	1"7/8	42	64	68	34	660	1	3258950335155
E033516	1"3/4	40	60	66	32	560	1	3258950335162
E033517	1"13/16	42	62	66	32	620	1	3258950335179
E033518	2"	42	68	70	34	680	1	3258950335186





COMPOSIÇÃO DE CHAVES DE CAIXA 1"

CAIXA DE ROQUETE CHAVES DE CAIXA 1" - 14 PEÇAS

- Chaves de caixa 1" sextavadas: 41-46-50-55-60-65-70-75-80 mm.
- 2 extensões 1": 200-400 mm.
- 1 roquete 1".
- 1 cabo T corrediço 1".
- Fornecido em caixa metálica.



E034701	1"	Qde	Dimensões	Peso kg	☒	EAN
		14	L.658xP.211xH.108 mm	29	1	3258950347011

ROQUETE 1"

ROQUETE 1"

- ISO 3315 - DIN 3122 - ISO 1174-1
- Bloqueio de segurança com chaves de caixa e acessórios.
- Botão de desbloqueio rápido.
- Aço crómio-vanádio.
- Acabamento: crómio mate.
- Fornecido com cabo truncável na cabeça do roquete.

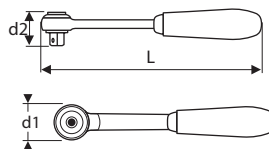
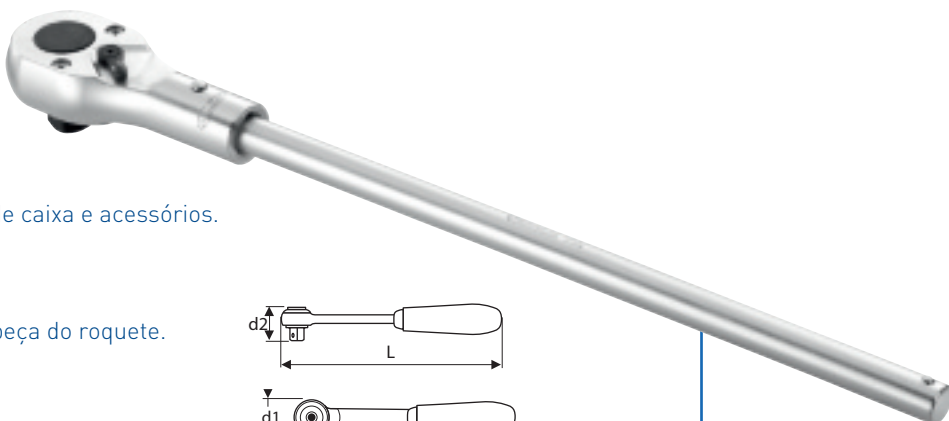

E034601	d1 mm	d2 mm	L mm	Peso kg	☒	EAN
	71.5	71	666	2	1	3258950346014

ACESSÓRIOS 1"

CABO "T" CORREDIÇA

- ISO 3316 - DIN 3123 - ISO 1174-1
- Fixação de segurança.
- Botão de desbloqueio rápido.
- Aço crómio vanádio.
- Acabamento: crómio mate.

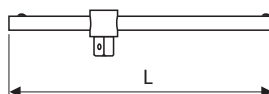

E034503	L mm	Peso kg	☒	EAN
	500	2,4	1	3258950345031



EXTENSÕES 1"

- ISO 3316 - DIN 3123 - ISO 1174-1
- Bloqueio de segurança.
- Botão de desbloqueio rápido.
- Acabamento: crómio mate.
- Aço crómio-vanádio.

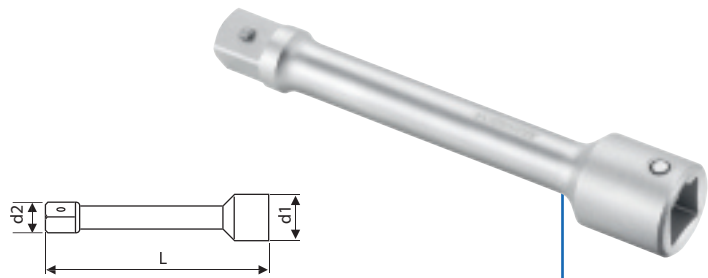

	d1 mm	d2 mm	L mm	Peso kg	☒	EAN
E034501	48	33.5	200	1,1	1	3258950345017
E034502	48	33.5	400	2	1	3258950345024

REDUTOR 1" - 3/4"

- ISO 3316 - DIN 3123 - ISO 1174-1
- Aço crómio-vanádio.
- Acabamento: crómio mate.
- Bloqueio de segurança.
- Para uma utilização manual.

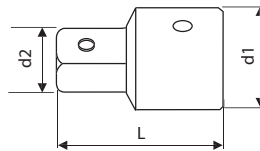

	d1 mm	d2 mm	L mm	Peso g	☒	EAN
E033803	42	33.5	80	415	1	3258950338033

CHAVES DE CAIXA 1"

CHAVES DE CAIXA 1" - SEXTAVADAS - MÉTRICAS

- ISO 2725-1 - DIN 3124 - ISO 1174-1 - ISO 1711-1 ISO 691
- Fixação de segurança.
- Botão de desbloqueio rápido.
- Acabamento: crómio mate.
- Aço crómio vanádio.
- Para uma utilização manual.

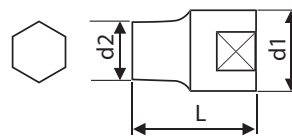

	A mm	d1 mm	d2 mm	L mm	Peso g	☒	EAN
E034101	41	47	45	70	685	1	3258950341019
E034102	46	65	50	75	852	1	3258950341026
E034103	50	70	50	75	968	1	3258950341033
E034104	55	76	55	80	1262	1	3258950341040
E034105	60	82	55	84	1432	1	3258950341057
E034106	65	88	55	87	1652	1	3258950341064
E034107	70	94	60	70	1921	1	3258950341071
E034108	75	100	60	97	2261	1	3258950341088
E034109	80	105	60	103	2800	1	3258950341095



APARAFUSAMENTO





Chave de parafusos

P.104



Chave de fendas primo

P.112



Chaves de caixa com cabo

P.116



Jogo chaves sextavadas

P.117



Chaves sextavadas

P.118



Chaves sextavadas em T

P.123



Caixa de chaves de pancada

P.127



Ponteiras de aperto

P.128



Pontas

P.130



Porta-pontas e acessórios

P.132



FENDA 1000V E PRECISÃO chave de fenda.....

Consulte a secção de Electricidade-Electronics página 218.

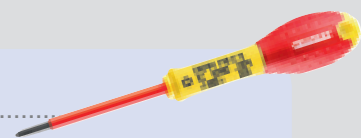



JOGO DE CHAVES DE PARAFUSOS

JOGO DE 10 CHAVES DE PARAFUSOS

- Chave para parafusos de fenda (mecânico): 2,5 x 75 - 3 x 75 - 4 x 100 - 5,5 x 125 - 6,5 x 150 (porca)
- Chave para parafusos de fenda (compacta): 4 x 30 mm.
- Chave de parafusos Phillips®: PH0 x 75 - PH1 x 100 - PH2 x 125.
- Chave de parafusos Phillips® (compacta): PH2 x 30.



	Qtd	Peso g		EAN
E160905	10	740	5	3258951609057

JOGO DE 8 CHAVES DE PARAFUSOS

- Chave para parafusos de fenda (electricista): 3 x 50 - 4 x 100 mm.
- Chave para parafusos de fenda (mecânico): 5,5 x 125 - 6,5 x 150 - 8 x 175 (porca) mm.
- Chave de parafusos Phillips®: PH0 x 75 - PH1 x 100 - PH2 x 125 (porca).



	Qtd	Peso g		EAN
E160904	8	800	5	3258951609040

JOGO DE 8 CHAVES DE PARAFUSOS

- Chave para parafusos de fenda (electricista): 3 x 50 - 4 x 100 mm.
- Chave para parafusos de fenda (mecânico): 5,5 x 125 - 6,5 x 150 - 8 x 175 (porca) mm.
- Chave de parafusos Pozidriv®: PZ0 x 75 - PZ1 x 100 - PZ2 x 125 (porca).



	Qtd	Peso g		EAN
E160906	8	800	5	3258951609064



JOGO DE 8 CHAVES DE PARAFUSOS

- Chave para parafusos de fenda (electricista): 3 x 50 - 4 x 100 mm.
- Chave para parafusos de fenda (mecânico): 5,5 x 125 - 6,5 x 150 mm.
- Chave de parafusos Pozidriv®: PZ1 x 100 - PZ2 x 125.
- Chave de parafusos Phillips®: PH1 X 100 - PH2 x 125.



	Qtd	Peso g		EAN
E160907	8	710	5	3258951609071



JOGO DE 6 CHAVES DE PARAFUSOS

- Chave para parafusos de fenda (mecânico): 2,5 x 75 - 3 x 75 - 4 x 100 - 5,5 x 125 mm.
- Chave de parafusos Phillips®: PH1 x 100 - PH2 x 125.



	Qtd	Peso g		EAN
E160902	6	430	5	3258951609026



JOGO DE 6 CHAVES DE PARAFUSOS

- Chave para parafusos de fenda (electricista): 3,5 x 75 - 5,5 x 125 mm.
- Chave para parafusos de fenda (mecânico): 6,5 x 150 - 8 x 175.
- Chave de parafusos Pozidriv®: PZ1 x 100 - PZ2 x 125.

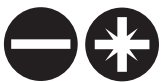

	Qtd	Peso g		EAN
E160903	6	720	5	3258951609033





JOGO DE CHAVES DE PARAFUSOS

JOGO DE 5 CHAVES DE PARAFUSOS

- Chave para parafusos de fenda (electricista): 3,5 x 75 - 4 x 100 - 5,5 x 125 mm.
- Chave de parafusos Phillips®: PH1 x 100 - PH2 x 125.



E160901	Qtd	Peso g		EAN
E160901	5	330	5	3258951609019

MÓDULO DE 8 CHAVES DE PARAFUSOS

- Chave para parafusos de fenda (electricista): 3,5 x 75 - 4 x 100.
- Chave para parafusos de fenda (mecânico): 5,5 x 125 - 6,5 x 150 - 8 x 175 (porca).
- Chave de parafusos Phillips®: PH0 x 75 - PH1 x 100 - PH2 x 12.
- Tabuleiro vazio: E160916.



E194940	Qtd	L mm	L mm	Peso g		EAN
E194940	8	354	173	914	1	3258951949405



Todos os jogos de chaves são fornecidos em caixa de cartão, à exceção do jogo de 5 chaves E160908 que é fornecido em embalagem blister.





JOGO DE 7 CHAVES DE PARAFUSOS TORX®

→ ACUMENT TMD 702

→ Chave de parafusos Torx®: T10-T15-T20-T25-T27-T30-T40.



	Qtd	Peso g		EAN
E160908	7	640	5	3258951609088



JOGO DE 7 CHAVES DE PARAFUSOS RÉSISTORX®

→ ACUMENT TMD 702

→ Chave de parafusos Resistorx®:
TT10-TT15-TT20-TT25-TT27-TT30-TT40.



	Qtd	Peso g		EAN
E160909	7	640	5	3258951609095



MÓDULO DE 6 CHAVES DE PARAFUSOS

→ Chave de parafusos Resistorx®: TT10-TT15-TT20-TT25-TT30-TT40.

→ Tabuleiro vazio: E160917.



	Qtd	L mm	L mm	Peso g		EAN
E194941	6	354	173	744	1	3258951949412





CHAVE DE PARAFUSOS

CHAVE PARA PARAFUSOS DE FENDA ELECTRICISTA

- ISO 2380-1 - ISO 2380-2
- Cabo ergonómico tri-matéria confortável e efi caz.
- Código de cores perfil: vermelho.
- Lâmina em aço de cromo-vanádio redonda fresada, cromada.
- Extremidade areada.

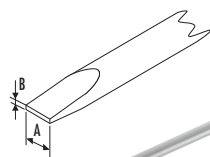
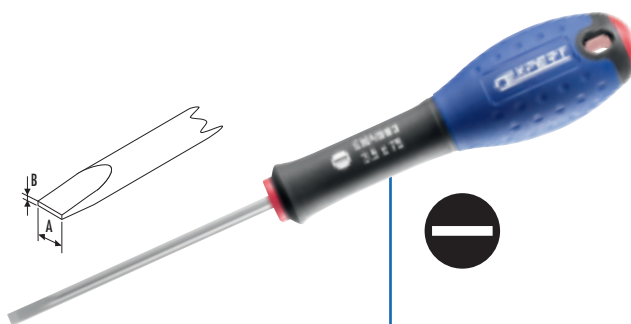

	A x L2 x B mm	L1 mm	d mm	Peso g	☒	EAN
E160101	2,0 x 50 x 0,4	149	20	16	5	3258951601013
E165006	2,5 x 50 x 0,4	149	20	18	5	3258951650066
E164978	3,0 x 50 x 0,5	149	20	20	5	3258951649787
E164983	3,5 x 75 x 0,6	177	27	37	5	3258951649831
E165017	4,0 x 100 x 0,8	202	27	43	5	3258951650172
E165093	4,0 x 150 x 0,8	252	27	50	5	3258951650936
E160102	4,0 x 250 x 0,8	352	27	65	5	3258951601020
E165476	5,5 x 125 x 1,0	230	32	80	5	3258951654767
E160103	5,5 x 250 x 1,0	355	32	104	5	3258951601037
E165096	6,5 x 150 x 1,2	266	40	133	5	3258951650967
E160104	6,5 x 250 x 1,2	366	40	164	5	3258951601044

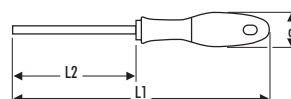

CHAVE PARA PARAFUSOS DE FENDA MECÂNICO

- ISO 2380-1 - ISO 2380-2
- Cabo ergonómico tri-matéria confortável e efi caz.
- Código de cores perfil: vermelho.
- Lâmina em aço de cromo-vanádio redonda fresada, cromada.
- Extremidade areada.

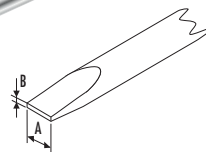
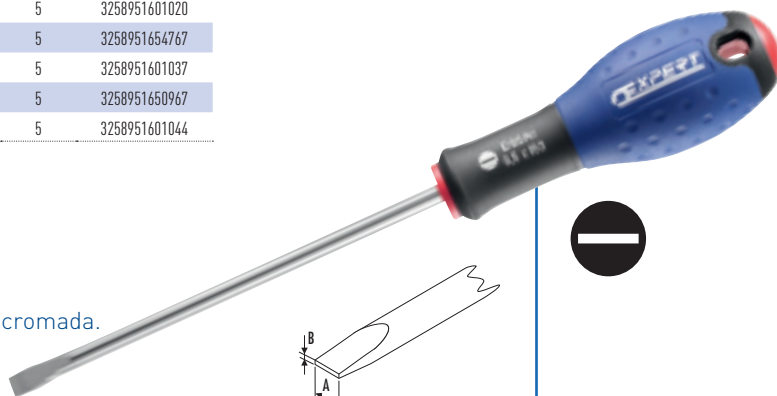

	A x L2 x B mm	L1 mm	d mm	Peso g	☒	EAN
E160201	2,5 x 75 x 0,4	177	27	28	10	3258951602010
E165479	3 x 75 x 0,5	173	30	31	10	3258951654798
E165480	3 x 100 x 0,5	198	38	32	10	3258951654804
E165016	4 x 100 x 0,8	202	43	42	10	3258951650165
E165481	4 x 125 x 0,8	227	47	46	10	3258951654811
E165483	5,5 x 150 x 1,0	227	32	47	10	3258951654835
E165098	5,5 x 100 x 1,0	205	32	69	10	3258951650981
E165482	5,5 x 125 x 1,0	230	32	73	10	3258951654828
E160206	6,5 x 125 x 1,2	241	40	117	10	3258951602065
E165141	6,5 x 150 x 1,2	266	40	123	10	3258951651414
E165138	8,0 x 175 x 1,6	291	40	177	10	3258951651384

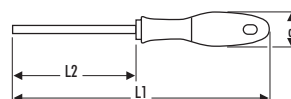

CHAVE PARA PARAFUSOS DE FENDA MECÂNICO COM SEXTAVADO

- ISO 2380-1 - ISO 2380-2
- Cabo ergonómico tri-matéria confortável e efi caz.
- Código de cores perfil: vermelho.
- Lâmina em aço de cromo-vanádio redonda fresada, cromada.
- Extremidade areada.
- Porca sextavada.

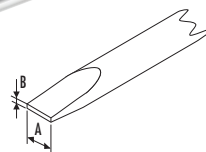
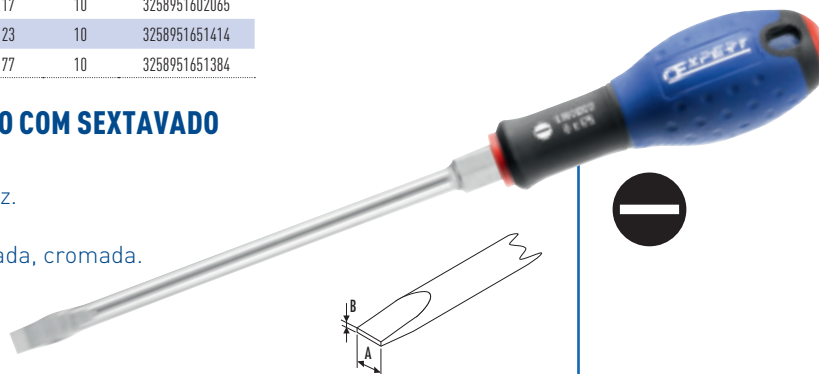

	A x L2 x B mm	L1 mm	d mm	Peso g	☒	EAN
E160202	6,5 x 150 x 1,2	266	40	130	5	3258951602027
E160203	8,0 x 175 x 1,2	266	40	150	5	3258951602034
E160204	10 x 200 x 1,6	226	40	226	5	3258951602041
E160205	12 x 250 x 2,0	366	40	289	5	3258951602058

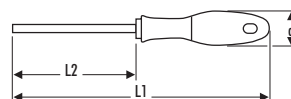



CHAVE CURTA COTO PARA PARAFUSOS DE FENDA ELECTRICISTA

- ISO 2380-1 - ISO 2380-2
- Cabo ergonómico tri-matéria confortável e efi caz.
- Código de cores perfil: vermelho.
- Lâmina em aço de crómio-vanádio redonda fresada, cromada.
- Extremidade areada.
- Chave de parafusos compacta ideal para os parafusos de acesso difícil.

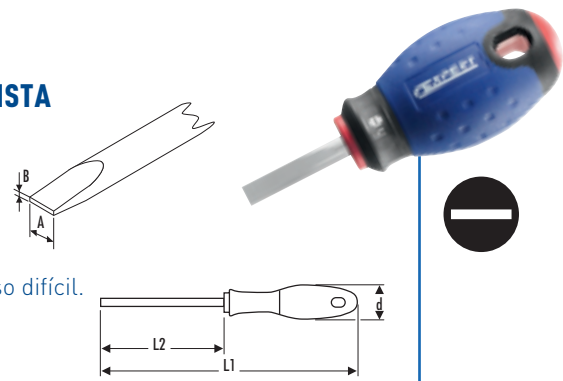

	A x L2 x B mm	L1 mm	d mm	Peso g	☒	EAN
E165484	4,0 x 25 x 0,8	86	32	33	5	3258951654842
E165400	5,5 x 25 x 1,0	86	32	39	5	3258951654002
E165404	6,5 x 25 x 1,2	86	32	45	5	3258951654040

CHAVE DE PARAFUSOS TORX®

- ACUMENT TMD 702
- Cabo ergonómico tri-matéria confortável e efi caz.
- Código de cores perfil: verde.
- Lâmina em aço de crómio-vanádio redonda, crómio acetinado.

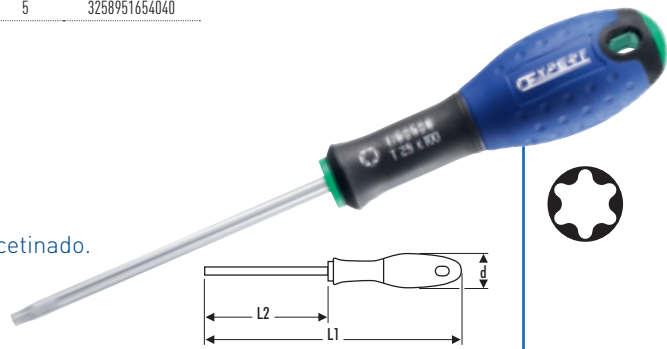

	N°	L1 mm	L2 mm	d mm	Peso g	☒	EAN
E160501	T6	148	50	20	18	5	3258951605011
E160502	T7	148	50	20	18	5	3258951605028
E160503	T8	148	50	20	18	5	3258951605035
E160504	T9	173	75	20	19	5	3258951605042
E160505	T10	177	75	27	34	5	3258951605059
E160506	T15	177	75	27	37	5	3258951605066
E160507	T20	202	100	27	44	5	3258951605073
E160508	T25	205	100	32	71	5	3258951605080
E160509	T27	205	100	32	75	5	3258951605097
E160510	T30	241	125	40	118	5	3258951605103
E160511	T40	241	125	40	135	5	3258951605110

CHAVE DE PARAFUSOS RESISTORX®

- ACUMENT TMD 702
- Cabo ergonómico tri-matéria confortável e efi caz.
- Código de cores perfil: verde.
- Lâmina em aço de crómio-vanádio redonda cromada.
- Extremidade areada.

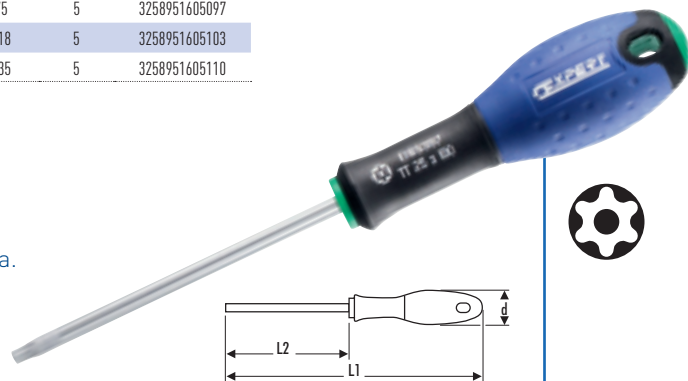

	N°	L1 mm	L2 mm	d mm	Peso g	☒	EAN
E165340	TT 10	177	75	27	34	5	3258951653401
E165395	TT 15	177	75	27	37	5	3258951653951
E165396	TT 20	202	100	27	44	5	3258951653968
E165397	TT 25	205	100	32	71	5	3258951653975
E160601	TT 27	205	100	32	75	5	3258951606018
E165398	TT 30	241	125	40	118	5	3258951653982
E165399	TT 40	241	125	40	135	5	3258951653999





CHAVE DE PARAFUSOS

CHAVE PARA PARAFUSOS PHILLIPS®

- ISO 8764-1 - ISO 8764-2
- Cabo ergonómico tri-matéria confortável e efi caz.
- Código de cores perfil: amarelo.
- Lâmina em aço de cromo-vanádio redonda cromada.
- Extremidade areada.

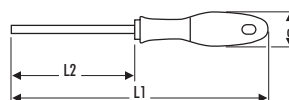
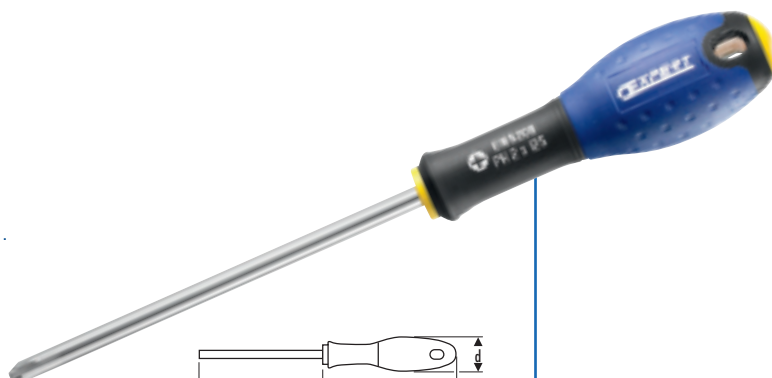

	N°	L1 mm	L2 mm	d mm	Peso g		EAN
E165204	PH 00	149	50	20	20	5	3258951652046
E165206	PH 0	177	75	27	44	10	3258951652060
E165207	PH 1	205	100	32	69	10	3258951652077
E165209	PH 2	230	125	32	88	10	3258951652091
E160304	PH 1	355	250	32	101	5	3258951603048
E160305	PH 2	355	250	32	123	5	3258951603055

CHAVE PARA PARAFUSOS PHILLIPS® COM SEXTAVADO

- ISO 8764-1 - ISO 8764-2
- Cabo ergonómico de dupla matéria confortável e eficaz.
- Código de cor forma: amarelo.
- Lâmina em aço com cromo-vanádio, redonda, cromada.
- Extremidade areada.
- Porca sextavada.

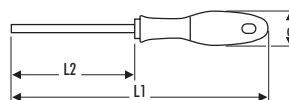

	N°	L1 mm	L2 mm	d mm	Peso g		EAN
E160301	PH 2	230	125	32	95	5	3258951603017
E160302	PH 3	266	150	40	167	5	3258951603024
E160303	PH 4	316	200	40	254	5	3258951603031

CHAVE CURTA COTO PARA PARAFUSOS PHILLIPS®

- ISO 8764-1 - ISO 8764-2
- Cabo ergonómico tri-matéria confortável e efi caz.
- Código de cores perfil: amarelo.
- Lâmina em aço de cromo-vanádio redonda fresada, cromada.
- Extremidade areada.
- Chave de parafusos compacta ideal para os parafusos de acesso difícil.

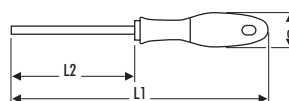

	N°	L1 mm	L2 mm	d mm	Peso g		EAN
E165406	PH 1	86	30	32	37	5	3258951654064
E165407	PH 2	86	30	32	42	5	3258951654071



CHAVE PARA PARAFUSOS POZIDRIV®

- ISO 8764-1 - ISO 8764-2
- Cabo ergonómico tri-matéria confortável e efi caz.
- Código de cores perfil: azul.
- Lâmina em aço de cromo-vanádio redonda cromada.
- Extremidade areada.

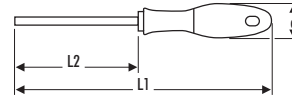

	N°	L1 mm	L2 mm	d mm	Peso g	☒	EAN
E165319	PZ 0	177	75	27	41	10	3258951653197
E165335	PZ 1	205	100	32	69	10	3258951653357
E165337	PZ 2	230	125	32	88	10	3258951653371

CHAVE PARA PARAFUSOS POZIDRIV® COM TOMADA SEXTAVADO

- ISO 8764-1 - ISO 8764-2
- Cabo ergonómico tri-matéria confortável e efi caz.
- Código de cores perfil: azul.
- Lâmina em aço de cromo-vanádio redonda cromada.
- Extremidade areada.
- Porca sextavada.

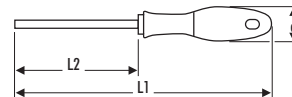
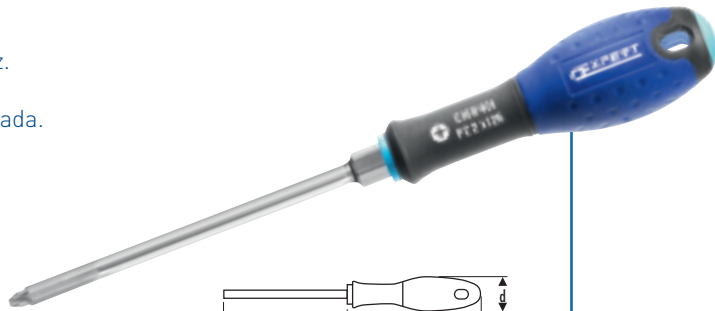

	N°	L1 mm	L2 mm	d mm	Peso g	☒	EAN
E160401	PZ 2	230	125	32	95	5	3258951604014
E160402	PZ 3	266	150	40	165	5	3258951604021
E160403	PZ 4	316	200	40	254	5	3258951604038

CHAVE CURTA COTO PARA PARAFUSOS POZIDRIV®

- ISO 8764-1 - ISO 8764-2
- Cabo ergonómico tri-matéria confortável e efi caz.
- Código de cores perfil: azul.
- Lâmina em aço de cromo-vanádio redonda fresada, cromada.
- Extremidade areada.
- Chave de parafusos compacta ideal para os parafusos de acesso difícil.

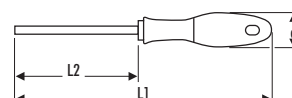

	N°	L1 mm	L2 mm	d mm	Peso g	☒	EAN
E165408	PZ 1	86	30	32	37	5	3258951654088
E165409	PZ 2	86	30	32	42	5	3258951654095





APARAFUSAMENTO

Em complemento da sua gama de chaves tri-matéria, expert propõe uma oferta alternativa ainda mais competitiva com o nome BI-MATÉRIA.



CARACTERÍSTICAS

Ergonomia

Cabo

Código de cor

Lamina

Extremidade rugosa

Tri-matéria

Bi-matéria

Cromada

Zincada

GAMA

Lamina standard

Lamina longa

Lamina curta

Laminas com sextavado

Isoladas 1000V



JOGO DE CHAVES DE PARAFUSOS - BI-MATÉRIA

JOGO DE 10 CHAVES BI-MATÉRIA FENDA-PHILLIPS®-POZIDRIV®

- Chave para parafusos de fenda (eletricista): 2,5 x 50 - 3 x 50 - 4 x 100 mm.
- Chave para parafusos de fenda (mecânico): 5,5 x 125 - 6,5 x 150 mm.
- Chave Phillips®: PH0 x 75 - PH1 x 100 - PH2 x 125.
- Chave Pozidriv® (compacta): PZ1 x 100 - PZ2 x 125.



E160924	Peso g 650	5	EAN 3258951609248
---------	---------------	---	----------------------



JOGO DE 7 CHAVES BI-MATÉRIA FENDA-PHILLIPS®

- Chave para parafusos de fenda (eletricista): 2,5 x 50 - 3 x 50 - 4 x 100 mm.
- Chave para parafusos de fenda (mecânico): 5,5 x 125 - 6,5 x 150 mm.
- Chave Phillips®: PH1 x 100 - PH2 x 125.



E160922	Peso g	📦	EAN
E160922	466	5	3258951609224



JOGO DE 7 CHAVES BI-MATÉRIA FENDA-POZIDRIV®

- Chave para parafusos de fenda (eletricista): 2,5 x 50 - 3 x 50 - 4 x 100 mm.
- Chave para parafusos de fenda (mecânico): 5,5 x 125 - 6,5 x 150 mm.
- Chave Pozidriv®: PZ1 x 100 - PZ2 x 125.



E160923	Peso g	📦	EAN
E160923	466	5	3258951609231



JOGO DE 5 CHAVES BI-MATÉRIA FENDA-PHILLIPS®

- Chave para parafusos de fenda (eletricista): 3,5 x 75 - 4 x 100 mm.
- Chave para parafusos de fenda (mecânico): 5,5 x 125 mm.
- Chave Phillips®: PH1 x 100 - PH2 x 125.



E160920	Peso g	📦	EAN
E160920	330	5	3258951609200





JOGO DE CHAVES DE PARAFUSOS - BI-MATÉRIA

JOGO DE 5 CHAVES BI-MATÉRIA FENDA-POZIDRIV®

- Chave para parafusos de fenda (eletricista): 3,5 x 75 - 4 x 100 mm.
- Chave para parafusos de fenda (mecânico): 5,5 x 125 mm.
- Chave Pozidriv®: PZ1 x 100 - PZ2 x 125.



E160921	Peso g	📦	EAN
	330	5	3258951609217

CHAVE DE FENDAS BI-MATÉRIA

CHAVE BI-MATÉRIA PARA PARAFUSO DE FENDA ELETRICISTA

- ISO 2380-1 - ISO 2380-2
- Cabo ergonômico de dupla matéria confortável e eficaz.
- Lâmina em aço com cromo-vanádio, zincada.

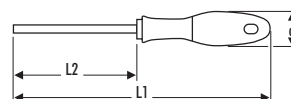
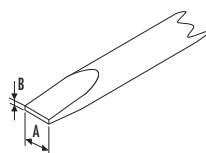

	A x L2 x B mm	L1 mm	d mm	Peso g	📦	EAN
E160250	2,5 x 50 x 0,4	149	20	16	5	3258951602508
E160252	3,5 x 75 x 0,6	177	27	37	10	3258951602522
E160253	4,0 x 100 x 0,8	202	27	43	10	3258951602539

CHAVE BI-MATÉRIA PARA PARAFUSO DE FENDA

- ISO 2380-1 - ISO 2380-2
- Cabo ergonômico de dupla matéria confortável e eficaz.
- Lâmina em aço com cromo-vanádio, zincada.

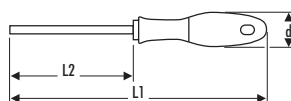
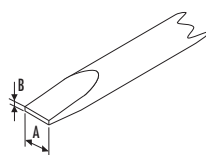
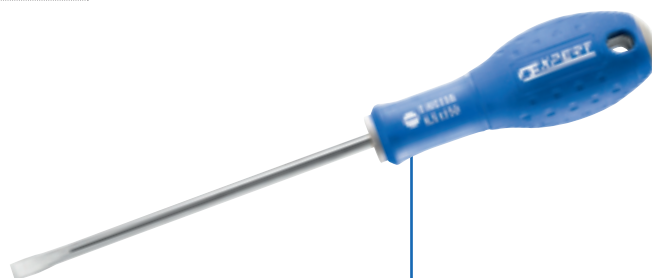

	A x L2 x B mm	L1 mm	d mm	Peso g	📦	EAN
E160254	5,5 x 125 x 1,0	230	32	69	10	3258951602546
E160255	6,5 x 150 x 1,2	266	40	123	10	3258951602553
E160256	8,0 x 175 x 1,6	291	40	177	10	3258951602560



CHAVE BI-MATÉRIA PARA PARAFUSOS PHILLIPS®

- ISO 8764-1 - ISO 8764-2
- Cabo ergonómico de dupla matéria confortável e eficaz.
- Lâmina em aço com crómio-vanádio, zincada.

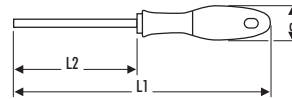

	L1 mm	L2 mm	d mm	Peso g	☒	EAN
E160340	177	75	27	44	10	3258951603406
E160341	205	100	32	69	10	3258951603413
E160342	230	125	32	88	10	3258951603420

CHAVE BI-MATÉRIA PARA PARAFUSOS POZIDRIV®

- ISO 8764-1 - ISO 8764-2
- Cabo ergonómico de dupla matéria confortável e eficaz.
- Lâmina em aço com crómio-vanádio, zincada.

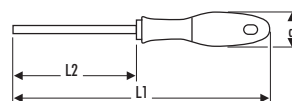

	L1 mm	L2 mm	d mm	Peso g	☒	EAN
E160410	177	75	27	41	10	3258951604106
E160411	205	100	32	69	10	3258951604113
E160412	230	125	32	88	10	3258951604120





MINI CHAVE

MINI CHAVE PLANA

- Cabo acetato de celulose azul.
- Lâmina redonda com cromo-vanádio, niquelada.
- Clip em E161111.

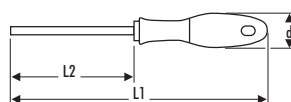
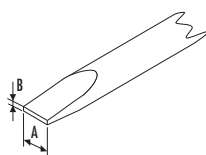

	A x L2 x B mm	L1 mm	L2 mm	d mm	Peso g	☒	EAN
E161110	2,0x35x0,4	75	35	12,5	7	1	3258951611104
E161111	2,5x35x0,4	110	50	13	10	1	3258951611111

CHAVES DE CAIXA COM CABO

CHAVES DE CAIXA COM CABO MÉTRICAS

- ISO 2236 - DIN 3125
- Cabo ergonómico de dupla matéria confortável e eficaz.
- Código de cor forma: cinzento.
- Lâmina em aço com cromo-vanádio, cromada.

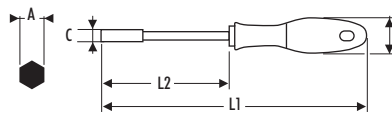

	A mm	L1 mm	L2 mm	C mm	d mm	Peso g	☒	EAN
E121501	5	230	125	8	32	78	1	3258951215012
E121502	5,5	230	125	8,8	32	78	1	3258951215029
E121503	6	230	125	9,4	32	80	1	3258951215036
E121504	7	230	125	11	32	100	1	3258951215043
E121505	8	240	125	12	40	125	1	3258951215050
E121506	9	240	125	13,3	40	132	1	3258951215067
E121507	10	240	125	14,5	40	148	1	3258951215074
E121517	13	240	125	18,5	40	220	1	3258951215173



JOGO CHAVES SEXTAVADAS

JOGO DE 7 CHAVES MACHO SEXTAVADAS MÉTRICAS

- Em suporte plástico, estojo compacto e resistente.
- Tipo navalha de bolso.
- Acabamento brunido.



E469262	Qtd	Conteúdo	Peso g	☒	EAN
E469262	7	2,5-3-4-5-6-8-10 mm.	250	12	3258954692629

JOGO DE 8 CHAVES MACHO TORX®

- Em suporte plástico, estojo compacto e resistente.
- Tipo navalha de bolso.
- Acabamento: brunido.



E469263	Qtd	Conteúdo	Peso g	☒	EAN
E469263	8	T9-T10-T15-T20-T25-T27-T30-T40	156	12	3258954692636





CHAVES SEXTAVADAS

JOGO DE 9 CHAVES MACHO SEXTAVADAS MÉTRICAS

- Em suporte plástico, estojo compacto e resistente.
- Chaves em aço de cromo-vanádio, galvanizadas.
- Longas de cabeça esférica.



	Qtd	Conteúdo	Peso g		EAN
E113947	9	1,5-2-2,5-3-4-5-6-8-10 mm	350	1	3258951139479

CHAVES MACHO SEXTAVADAS LONGAS MÉTRICAS

- ISO 2936 - DIN 911
- Fabricada em aço de cromo-vanádio para uma resistência ao binário superior às normas em vigor.
- Arestas das faces das extremidades microchanfradas para uma melhor resistência na cabeça do parafuso.
- Acabamento: galvanizada.

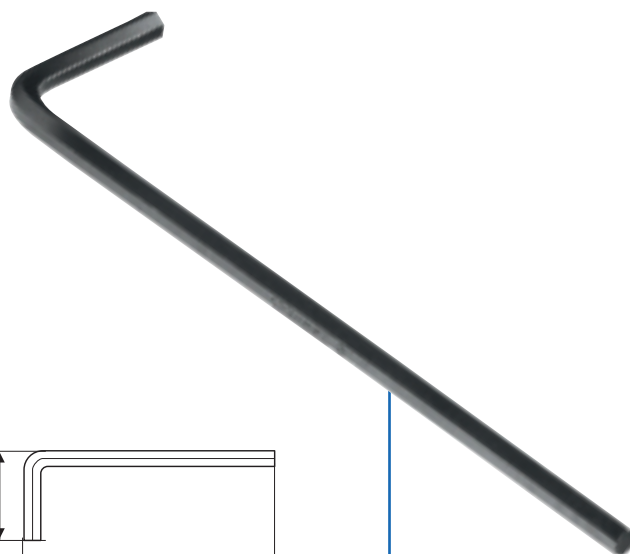

	A mm	L mm	l mm	Peso g		EAN
E113930	1,5	64	16	150	10	3258951139301
E113931	2	77	18	2	10	3258951139318
E113932	2,5	88	21	4	10	3258951139325
E113933	3	93	23	7	10	3258951139332
E113934	4	104	29	13	10	3258951139349
E113935	5	120	33	24	10	3258951139356
E113936	6	141	38	41	10	3258951139363
E113938	8	158	44	81	10	3258951139387
E113939	10	180	50	142	10	3258951139394
E120303	12	202	57	218	5	3258951203033
E120301	9	169	47	108	10	3258951203019
E120302	11	191	53	182	5	3258951203026
E120304	14	229	70	354	1	3258951203040
E120305	17	262	80	562	1	3258951203057



JOGO DE 10 CHAVES MACHO SEXTAVADAS MÉTRICAS

- Em suporte plástico, estojo compacto e resistente.
- Jogo económico.
- Acabamento: fosfato preto.

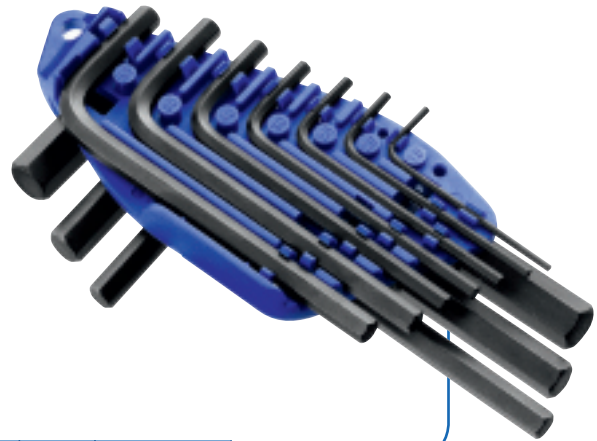

	Qtd	Conteúdo	Peso g		EAN
E069253	10	2-2,5-3-4-5-6-7-8-9-10 mm	310	12	3258950692531

JOGO DE 8 CHAVES MACHO SEXTAVADAS EM POLEGADAS

- Em suporte plástico, estojo compacto e resistente.
- Chaves em aço de cromo-vanádio, galvanizadas.
- Longas



	Qtd	Conteúdo	Peso g		EAN
E121101	9	1/16"-5/64"-3/32"-1/8"-5/32"-3/16"-7/32"-1/4"-3/8"	290	1	3258951211014

JOGO DE 9 CHAVES MACHO SEXTAVADAS MÉTRICAS

- Em suporte plástico, estojo compacto e resistente.
- Chaves em aço de cromo-vanádio, galvanizadas.
- Longas.



	Qtd	Conteúdo	Peso g		EAN
E113976	9	1,5-2-2,5-3-4-5-6-8-10 mm	350	1	3258951139769





CHAVES SEXTAVADAS

CHAVES MACHO SEXTAVADAS LONGAS EM POLEGADAS

→ ISO 2936 - DIN 911

- A cabeça esférica permite uma deslocação até 15°; para um aperto fácil e rápido, nos locais de acesso difícil.
- Permite também uma penetração rápida e fácil no perfil do parafuso.
- Acabamento: galvanizada.



	A mm	L mm	l mm	Peso g		EAN
E113964	1,5	64	16	1	10	3258951139646
E113965	2	77	18	2	10	3258951139653
E113966	2,5	88	21	4	10	3258951139660
E113967	3	93	23	8	10	3258951139677
E113968	4	104	29	14	10	3258951139684
E113969	5	120	33	24	10	3258951139691
E113970	6	141	38	36	10	3258951139707
E113972	8	158	44	80	10	3258951139721
E113974	10	180	50	139	10	3258951139745



JOGO DE 8 CHAVES MACHO SEXTAVADAS EM POLEGADAS

- Em suporte plástico, estojo compacto e resistente.
- Chaves em aço de cromo-vanádio, galvanizadas.
- Longas de cabeça esférica.



	Qtd	Conteúdo	Peso g		EAN
E117816	9	1/16"-5/64"-3/32"-1/8"-5/32"-3/16"-7/32"-1/4"-3/8"	290	1	3258951178164



CHAVES SEXTAVADAS LONGAS COM CABEÇA ESFÉRICA

→ ISO 2936 - DIN 911

- A cabeça esférica permite desapertar até 15°, para um desaperto fácil e rápido, nos sitios de acesso difícil.
- Permite um encaixe rápido e fácil da ponta da chave.
- Acabamento: negro fosfatado.



	A "	L mm	l mm	Peso g		EAN
E120601	1/16"	78	16	2	5	3258951206010
E120603	3/32"	88	19	5	5	3258951206034
E120602	5/64"	83	17	3	5	3258951206027
E120604	1/8"	98,5	22	8	5	3258951206041
E120605	5/32"	108	25	12	5	3258951206058
E120606	3/16"	119	28,5	20	5	3258951206065
E120607	7/32"	129,5	32	39	5	3258951206072
E120608	1/4"	140	35	50	5	3258951206089
E120609	3/8"	181	44,5	130	5	3258951206096

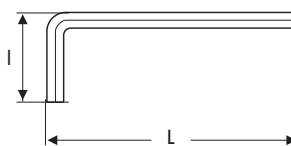



JOGO DE 9 CHAVES MACHO SEXTAVADAS MÉTRICAS

- Em suporte plástico, estojo compacto e resistente.
- Chaves em aço de cromo-vanádio, galvanizadas.
- Curtas



	Qty	Conteúdo	Peso g		EAN
E113929	9	1,5-2-2,5-3-4-5-6-8-10 mm.	260	1	3258951139295

CHAVES MACHO SEXTAVADAS CURTAS MÉTRICAS

- ISO 2936 - DIN 911
- Fabricada em aço de cromo-vanádio para uma resistência ao binário superior às normas em vigor.
- Arestas das faces das extremidades microchanfradas para uma melhor resistência na cabeça do parafuso.
- Acabamento: galvanizado.



	A mm	L mm	l mm	Peso g		EAN
E120101	0,9	41	11	50	10	3258951201015
E113911	1,3	42	14	1	10	3258951139110
E113912	1,5	47	16	1	10	3258951139127
E113913	2	52	18	3	10	3258951139134
E113914	2,5	59	21	3	10	3258951139141
E113915	3	66	23	6	10	3258951139158
E120102	3,5	70	26	7	10	3258951201022
E113916	4	74	29	10	10	3258951139165
E120103	4,5	80	31	13	10	3258951201039
E113917	5	85	33	18	10	3258951139172
E113918	6	96	38	30	10	3258951139189
E113919	7	102	41	43	10	3258951139196
E113920	8	108	44	60	10	3258951139202
E113921	9	114	47	79	10	3258951139219
E113922	10	122	50	104	10	3258951139226
E113923	11	129	53	143	5	3258951139233
E113924	12	137	57	168	5	3258951139240
E113925	13	145	63	212	1	3258951139257
E113926	14	154	70	264	1	3258951139264
E113927	17	177	80	444	1	3258951139271
E113928	19	199	89	555	1	3258951139288





CHAVES MACHO TORX®

JOGO DE 7 CHAVES MACHO TORX®

- Em suporte plástico, estojo compacto e resistente.
- Chaves em aço de cromo-vanádio, acabamento fosfato preto.



	Qty	Conteúdo	Peso g		EAN
E121102	7	T10-T15-T20-T25-T27-T30-T40	110	1	3258951211021

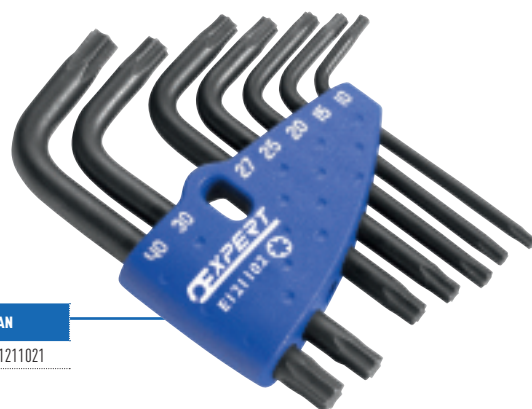

CHAVES MACHO TORX®

- ACUMENT TMD 702
- Acabamento: fosfato preto.



	N°	L mm	l mm	Peso g		EAN
E113994	T10	54	20	4	10	3258951139943
E113995	T15	58	22	5	10	3258951139950
E113996	T20	61	24	7	10	3258951139967
E113997	T25	66	25	9	10	3258951139974
E113998	T27	69	27	15	10	3258951139981
E113999	T30	76	30	20	10	3258951139998
E113854	T40	83	33	29	10	3258951138540

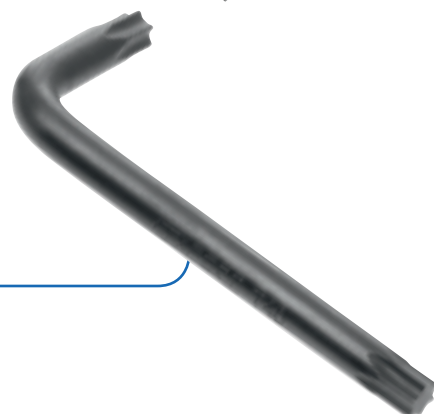

JOGO DE CHAVES MACHO RÉSISTORX® EM SUPORTE PLÁSTICO

- Estojo compacto e resistente.
- Chaves em aço de cromo-vanádio, acabamento fosfato preto.



	Qty	Conteúdo	Peso g		EAN
E121103	7	TT10-TT15-TT20-TT25-TT27-TT30-TT40	110	1	3258951211038



CHAVES MACHO RESISTORX®

- ACUMENT TMD 702
- Acabamento: fosfato preto.

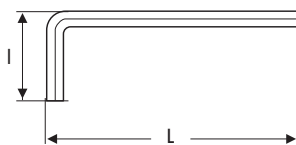

	N°	L mm	l mm	Peso g		EAN
E113858	TT10	54	20	4	10	3258951138588
E113859	TT15	58	22	5	10	3258951138595
E113860	TT20	61	24	7	10	3258951138601
E113861	TT25	66	25	9	10	3258951138618
E120901	TT27	69	27	15	5	3258951209011
E113862	TT30	76	30	20	10	3258951138625
E113863	TT40	83	33	29	10	3258951138632

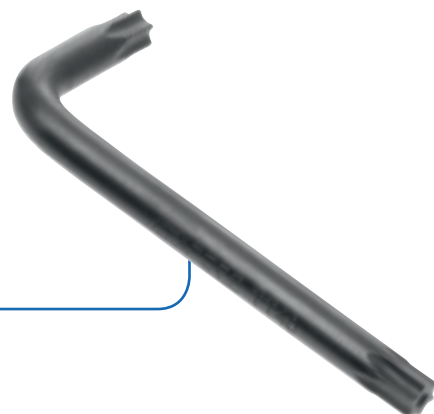



CHAVES SEXTAVADAS EM T

JOGOS DE 7 CHAVES MACHO EM T COM CABO SEXTAVADAS MÉTRICAS

- Chaves macho em T com cabo sextavadas:
- 2,5-3-4-5-6-8-10 mm.

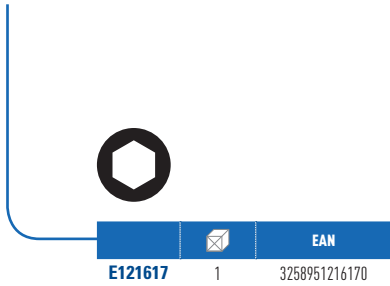

CHAVES MACHO EM T COM CABO SEXTAVADAS MÉTRICAS

- ISO 2936 - DIN 911
- Pega em T ergonómica para uma utilização eficaz das duas extremidades da chave.
- Aço de silício.
- Acabamento: fosfato preto.

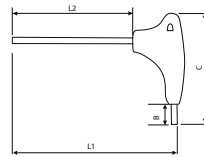
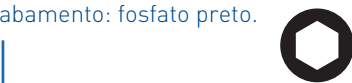

	A mm	L1 mm	L2 mm	B mm	C mm	Peso g		EAN
E121602	2	127	100	10	52	18	18	3258951216026
E121601	2,5	127	100	10	52	20	5	3258951216019
E121603	3	127	100	10	52	21	5	3258951216033
E121604	4	183	150	11	66	47	5	3258951216040
E121605	5	183	150	11	66	60	5	3258951216057
E121606	6	240	200	12	82	112	5	3258951216064
E121607	8	240	200	14	82	165	5	3258951216071
E121608	10	240	200	16	82	233	5	3258951216088

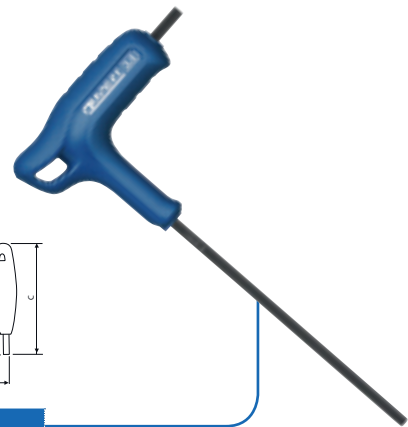

MÓDULO DE 8 CHAVES MACHO EM T COM CABO SEXTAVADAS

- Pega em T ergonómica para uma utilização eficaz das duas extremidades da chave.
- 6 chaves macho em T com cabo sextavadas de cabeça esférica: 4 - 5 - 6 - 7 - 8 - 10 mm.
- Tabuleiro vazio: E121205.

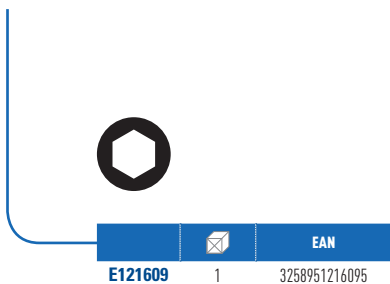



CHAVES SEXTAVADAS EM T

JOGOS DE 6 CHAVES MACHO EM T COM CABO SEXTAVADAS DE CABEÇA ESFÉRICA

→ Chaves macho em T com cabo sextavadas de cabeça esférica: 3-4-5-6-7-8 mm.



	Peso g	📦	EAN
E121616	755	1	3258951216163



CHAVES MACHO EM T COM CABO SEXTAVADAS DE CABEÇA ESFÉRICA MÉTRICA

→ ISO 2936 - DIN 911

→ Pega em T ergonómica para uma utilização eficaz das duas extremidades da chave.

→ Cabeça esférica que permite uma inclinação até 15°.

→ Aço de silício.

→ Acabamento: fosfato preto.

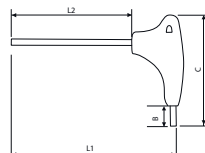

	A mm	L1 mm	L2 mm	B mm	C mm	Peso g	📦	EAN
E121610	4	183	150	11	66	47	5	3258951216101
E121611	5	183	150	12	66	60	5	3258951216118
E121612	6	240	200	12	82	112	5	3258951216125
E121613	7	240	200	13	82	137	5	3258951216132
E121614	8	240	200	14	82	165	5	3258951216149
E121615	10	240	200	16	82	233	5	3258951216156

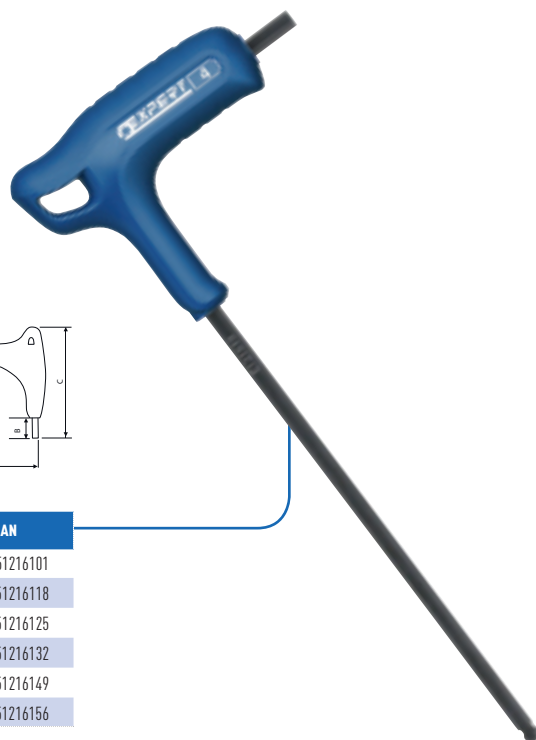

JOGO DE 7 CHAVES MACHO EM T COM CABO TORX®

→ Chaves macho em T com cabo Torx®: T10-T15-T20-T25-T27-T30-T40.



	Peso g	📦	EAN
E121709	355	1	3258951217092





CHAVES SEXTAVADAS EM T

MÓDULO DE 7 CHAVES MACHO EM T COM CABO TORX®

- Chaves macho em T com cabo Torx®: T10-T15-T20-T25-T27-T30-T40.
- Tabuleiro vazio: E121214.

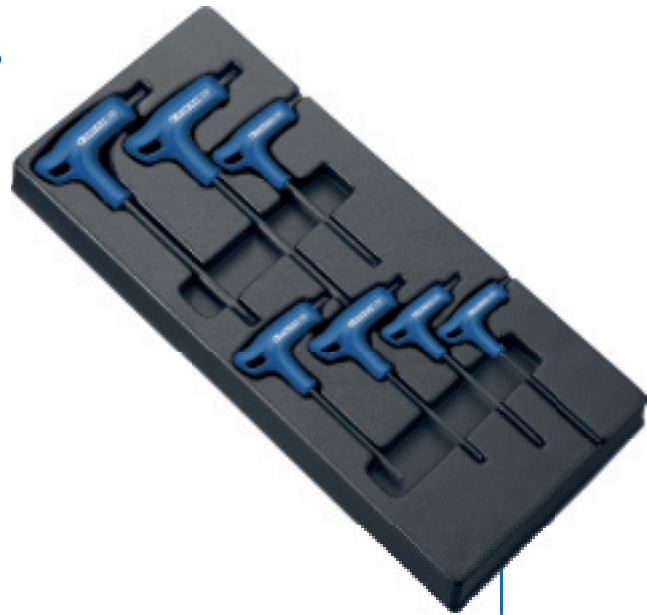

	Peso g		EAN
E121708	547	1	3258951217085

CHAVES MACHO EM T COM CABO TORX®

- **ACUMENT TMD 702**
- Pega em T ergonómica para uma utilização eficaz das duas extremidades da chave.
- Aço de silício.
- Acabamento: fosfato preto.

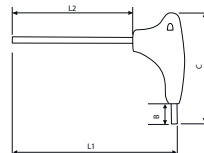

	N°	L1 mm	L2 mm	B mm	C mm	Peso g		EAN
E121701	T10	126	100	10	52	18	5	3258951217016
E121702	T15	126	100	10	52	25	5	3258951217023
E121703	T20	133	100	11	66	35	5	3258951217030
E121704	T25	133	100	12	66	50	5	3258951217047
E121705	T27	133	100	12	66	55	5	3258951217054
E121706	T30	191	150	12	82	60	5	3258951217061
E121707	T40	191	150	14	82	112	5	3258951217078





CHAVES SEXTAVADAS EM T

CHAVES MACHO EM T SEXTAVADAS

→ UNI 2936 - ISO 2936 - DIN ISO 2936

→ Precisão dimensional que garante um acoplamento perfeito com o parafuso.

→ Corpo em aço com cromo-vanádio.

→ Acabamento: cromado, brilhante.

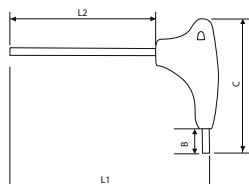

	A mm	L1 mm	L2 mm	C mm	Peso g	☒	EAN
E121215	2	125	117	62.5	19	5	3258951212158
E121216	2.5	125	117	62.5	19	5	3258951212165
E121217	3	150	142	75	24	5	3258951212172
E121218	3.5	150	142	75	24	5	3258951212189
E121219	4	180	170	90	62	5	3258951212196
E121220	4.5	180	170	90	62	5	3258951212202
E121221	5	210	198	105	99	5	3258951212219
E121222	6	210	196	105	135	5	3258951212226
E121223	7	210	196	105	135	5	3258951212233
E121224	8	250	234	125	200	5	3258951212240
E121226	10	300	279.5	150	410	5	3258951212264
E121227	12	320	296	160	590	5	3258951212271
E121228	14	340	312	170	830	5	3258951212288

JOGO DE CHAVES MACHO EM T SEXTAVADAS

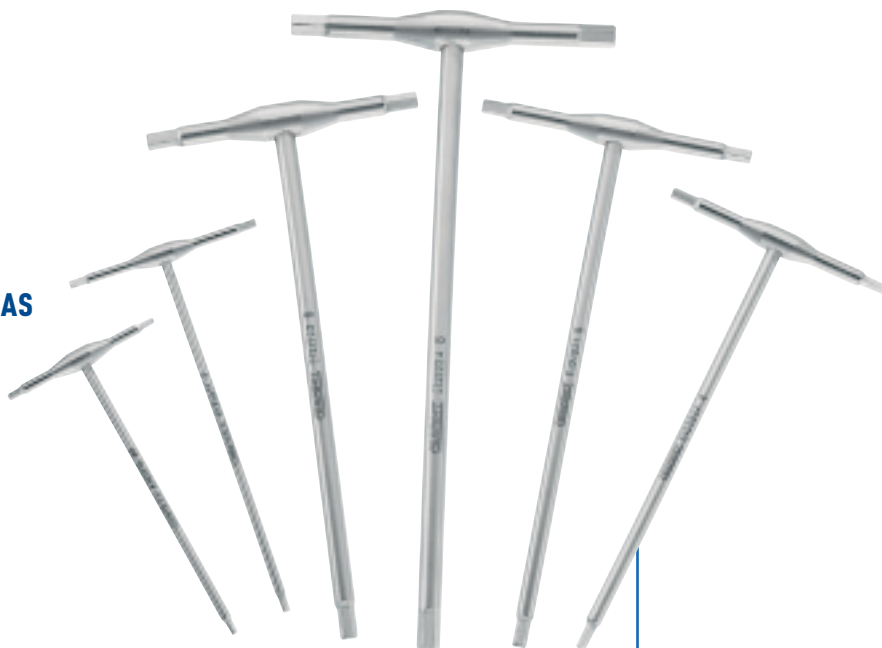

	Conteúdo	Peso g	☒	EAN
E121229	2,5 - 3 - 4 - 5 - 6 - 8 mm.	550	1	3258951212295
E121230	2 - 2,5 - 3 - 3,5 - 4 - 4,5 - 5 - 6 - 7 - 8 - 10 - 12 - 14 mm.	2610	1	3258951212301



CAIXA DE CHAVES DE PANCADA

CAIXA DE CHAVES DE PANCADA - 12 PEÇAS

- Desbloqueio rápido e com toda a segurança dos parafusos gripados, enferrujados ou colados.
- Entregue em caixa metálica.
- Conteúdo:
 - Chave de pancada 1/2".
 - Chave de caixa porta-pontas 1/2" - 5/16".
 - Ponta extrator n.º3, C.36 mm.
 - Ponta extrator n.º4, C.71 mm.
 - 2 pontas para parafusos de fenda 8-10 mm, C.36 mm.
 - 2 pontas para parafusos Phillips® 2-3 mm, C.36 mm.
 - 2 pontas para parafusos de fenda 8-10 mm, C.80 mm.
 - 2 pontas para parafusos Phillips® 2-3 mm, C.80 mm.



E230301	Peso g	📦	EAN
1250	1	3258952303015	

PONTAS

MÓDULO DE CHAVES MACHO

- Caixa de pontas e acessórios 49 peças com:
- Pontas de fenda: 4-4,5-5,5-6,5x2-8 mm.
- Pontas Phillips®: PH1x2-PH2x3-PH3.
- Pontas Pozidriv®: PZ1x2-PZ2x3-PZ3x2.
- Pontas Torx®: T10x2-T15x2-T20x2-T25x2-T30x2.
- Pontas ResisTorx®: TT10-TT15x2-TT20x2-TT25x2-TT30x2-TT40.
- Pontas sextavadas: 2-3x2-4x2-5x2-6x2 mm.
- Porta-pontas magnético com anel de fixação.
- Chave de fenda porta-pontas revólver de roquete + 7 pontas: fenda: 4-5,5-6 mm, Phillips®: PH1-PH2, Pozidriv®: PZ1-PZ2.
- Jogo de 9 chaves macho sextavadas métricas num estojo: 1,5-2-2,5-3-4-5-6-8-10 mm.
- Jogo de 7 chaves macho Torx® num estojo: T10-T15-T20-T25-T27-T30-T40 mm.
- Adaptador chaves de caixa 1/4".
- Tabuleiro vazio: E121106.



E121105	Qtd	Peso g	📦	EAN
5	1392	1	3258951211052	





PONTAS

CAIXA DE PONTAS 1/4" - 100 PEÇAS

- Pontas de fenda: 3 - 4 - 4,5 - 5 - 5,5 - 6 - 6,5 - 7 - 8 mm.
- Pontas Phillips®: PH00 - PH0 - PH1x2 - PH2x2 - PH3 - PH4.
- Pontas Pozidriv®: PZ1 - PZ2x2 - PZ3 - PZ4.
- Pontas sextavadas métricas: 1,5 - 2 - 2,5 - 3 - 4 - 5 - 5,5 - 6 - 7 - 8 mm.
- Pontas sextavadas em polegadas: 1/16" - 5/64" - 3/32" - 7/64" - 1/8" - 9/64" - 5/32" - 3/16" - 7/32" - 1/4".
- Pontas Tri-wing®: #1 - #2 - #3 - #4.
- Pontas Spanner®: #4 - #6 - #8 - #10 - #12.
- Pontas Torq-set®: #6 - #8 - #10.
- Pontas quadrado Robertson: #0 - #1 - #2x2 - #3.
- Pontas borboleta: 1/8" - 5/32" - 3/16" - 1/4" - 5/16".
- Pontas XZN®: M5 - M6 - M8.
- Pontas Torx®: T8 - T9 - T10 - T15 - T20 - T25 - T27 - T30 - T40 - T45.
- Pontas sextavadas com proteção, métricas: 2 - 2,5 - 3 - 4 - 5 - 6mm.
- Pontas sextavadas com proteção, em polegadas: 5/64" - 3/32" - 7/64" - 1/8" - 9/64" - 5/32".
- Pontas Resistorx®: TT8 - TT10 - TT15 - TT20 - TT25 - TT27 - TT30 - TT35 - TT40.
- Porta-pontas magnético 1/4" [E113648].
- Porta-pontas com bloqueio 1/4" [E168733].



E131709	Qtd	Peso g	📦	EAN
E131709	100	902	1	3258951317099



PONTAS PARA PARAFUSOS PERFIL POZIDRIV® 25 MM - 1/4"

- Pontas fenda: 4 - 4,5 - 5,5 - 6,5x2 - 8 mm.
- Pontas Phillips®: PH1x2 - PH2x3 - PH3.
- Pontas Pozidriv®: PZ1x2 - PZ2x3 - PZ3x2.
- Pontas Torx®: T10x2 - T15x2 - T20x2 - T25x2 - T30x2.
- Pontas ResisTorx®: T10 - T15x2 - T20x2 - T25x2 - T30x2 - T40.
- Pontas sextavadas: 2 - 3x2 - 4x2 - 5x2 - 6x2 mm.
- Porta-bits com anel de fixação.



E131701	Qtd	Peso g	📦	EAN
E131701	49	392	10	3258951317013



SELEÇÃO EM ESTOJO DE PONTAS 1/4" - 39 PEÇAS

- Pontas fenda: 4 - 5,5 - 6,5 - 8 mm.
- Pontas Phillips®: PH1 - PH2x2 - PH3.
- Pontas Pozidriv®: PZ1 - PZ2 - PZ3.
- Pontas Torx®: T8 - T10 - T15 - T20 - T25 - T30 - T40.
- Pontas ResisTorx®: TT10 - TT15 - TT20 - TT25 - TT27 - TT30 - TT40.
- Pontas sextavadas: 3 - 4 - 5 - 6 mm.
- Porta-bits com anel de fixação.
- Chaves de caixa sextavadas: 6 - 7 - 8 - 10 - 11 - 12 - 13 mm.
- Adaptador chaves de caixa.
- Mini-roquete.



E131705	Qtd	Peso g	📦	EAN
E131705	39	445	10	3258951317051





SELEÇÃO EM ESTOJO DE PONTAS 1/4" - 32 PEÇAS

- Pontas fenda: 4 - 5,5 - 6,5 - 8 mm.
- Pontas Phillips®: PH1 - PH2 - PH3.
- Pontas Pozidriv®: PZ1 - PZ2 - PZ3.
- Pontas Torx®: T8 - T10 - T15 - T20x2 - T25x2 - T30 - T40.
- Pontas ResisTorx®: T10 - T15 - T20 - T25 - T27 - T30 - T40.
- Pontas sextavadas: 3 - 4 - 5 - 6 mm.
- Mini-roquete.
- Porta-bits com anel de fixação.



	Qtd	Peso g		EAN
E131702	32	367	10	3258951317020



SELEÇÃO EM ESTOJO DE PONTAS 1/4" - 19 PEÇAS

- Pontas fenda: 4 - 4,5 - 5,5 mm.
- Pontas Phillips®: PH1 - PH2.
- Pontas Pozidriv®: PZ1 - PZ2 - PZ3.
- Pontas Torx®: T10 - T15 - T20 - T25 - T30 - T40.
- Pontas sextavadas: 3 - 4 - 5 - 6 mm.
- Porta-pontas magnético.



	Qtd	Peso g		EAN
E113901	19	188	20	3258951139011



CAIXA DE PONTAS 1/4" - 61 PEÇAS

- Pontas de fenda: 4 mm x 3 - 6 mm x 3.
- Pontas Phillips®: PH1 x 3 - PH2 x 6 - PH3 x 3.
- Pontas Pozidriv®: PZ1 x 3 - PZ2 x 6 - PZ3 x 3.
- Pontas sextavadas métricas: 4 mm x 3 - 5 mm x 3 - 6 mm x 3.
- Pontas Torx®: T10 x 3 - T15 x 3 - T20 x 3 - T25 x 3 - T27 x 3 - T30 x 3 - T40 x 3.
- Porta-pontas magnético 1/4".



	Qtd	Peso g		EAN
E131710	61	445	1	3258951317105





PONTAS

PONTAS PARA FENDA 25 MM - 1/4"

→ ISO 1173 - ISO 2380-1 - ISO 2351-1



	A mm	Sextavadas "	Qtd	Peso g	✉	EAN
E130101	4	1/4	6	42	20	3258951301012
E130103	5,5	1/4	6	46	20	3258951301036
E130104	6,5	1/4	6	46	20	3258951301043
E130102	4,5	1/4	6	42	20	3258951301029
E130105	8	1/4	6	63	20	3258951301050



PONTAS DE TORÇÃO PHILLIPS® 25 MM - 1/4"

→ ISO 1173 - ISO 8764-1 - ISO 2351-2



	N°	Sextavadas "	Qtd	Peso g	✉	EAN
E113685	PH 1	1/4	6	42	20	3258951136850
E113686	PH 2	1/4	6	46	20	3258951136867
E113687	PH 3	1/4	6	50	20	3258951136874



PONTAS DE TORÇÃO POZIDRIV® 25 MM - 1/4"

→ ISO 1173 - ISO 8764-1 - ISO 2351-2



	N°	Sextavadas "	Qtd	Peso g	✉	EAN
E113631	PZ 1	1/4	6	42	20	3258951136317
E113632	PZ 2	1/4	6	46	20	3258951136324
E113633	PZ 3	1/4	6	50	20	3258951136331



PONTAS SEXTAVADAS 25 MM - 1/4"

→ ISO 1173 - ISO 2936 - ISO 2351-3



	A mm	Sextavadas "	Qtd	Peso g	✉	EAN
E113650	2	1/4	6	50	20	3258951136508
E113651	2,5	1/4	6	54	20	3258951136515
E113652	3	1/4	6	54	20	3258951136522
E117768	4	1/4	6	54	20	3258951177686
E113654	5	1/4	6	54	20	3258951136546
E113655	6	1/4	6	63	20	3258951136553
E113656	7	1/4	6	75	20	3258951136560
E113657	8	1/4	6	75	20	3258951136577
E113658	10	1/4	6	88	20	3258951136584





PONTAS DE APARAFUSAR TORX® -25 MM - 1/4"

→ ISO 1173



	N°	Sextavadas"	Qty	Peso g	☒	EAN
E117771	T6	1/4	3	33	20	3258951177716
E117772	T7	1/4	3	33	20	3258951177723
E117773	T8	1/4	3	38	20	3258951177730
E117774	T9	1/4	3	38	20	3258951177747
E117775	T10	1/4	3	38	20	3258951177754
E117776	T15	1/4	3	38	20	3258951177761
E117777	T20	1/4	3	38	20	3258951177778
E117778	T25	1/4	3	38	20	3258951177785
E117779	T30	1/4	3	38	20	3258951177792
E117780	T40	1/4	3	42	20	3258951177808



PONTAS RESISTORX® 25 MM - 1/4"

→ ISO 1173



	N°	Sextavadas"	Qty	Peso g	☒	EAN
E117781	TT10	1/4	3	38	20	3258951177815
E117782	TT15	1/4	3	38	20	3258951177822
E117783	TT20	1/4	3	38	20	3258951177839
E117784	TT25	1/4	3	38	20	3258951177846
E117785	TT27	1/4	3	38	20	3258951177853
E117786	TT30	1/4	3	38	20	3258951177860
E117787	TT40	1/4	3	38	20	3258951177877



PONTAS PHILLIPS® 50 MM - 1/4"

→ ISO 1173 - ISO 8764-1 - ISO 2351-2



	N°	Sextavadas"	Qty	Peso g	☒	EAN
E113691	PH 1	1/4	6	70	20	3258951136911
E113692	PH 2	1/4	6	76	20	3258951136928
E113693	PH 3	1/4	6	82	20	3258951136935



PONTAS POZIDRIV® 50 MM - 1/4"

→ ISO 1173 - ISO 8764-1 - ISO 2351-2



	N°	Sextavadas"	Peso g	☒	EAN
E113637	PZ 1	1/4	70	20	3258951136379
E113638	PZ 2	1/4	76	20	3258951136386
E113639	PZ 3	1/4	82	20	3258951136393





PONTAS

PONTAS DE PERFIL SEXTAVADO 50 MM - 1/4"

→ ISO 1173 - ISO 2936 - ISO 2351-3



	A mm	Qty	Peso g	☒	EAN
E113659	3	6	70	20	3258951136591
E113660	4	6	76	20	3258951136607
E113661	5	6	82	20	3258951136614
E113662	6	6	88	20	3258951136621



CHAVES DE CAIXA MAGNÉTICAS PARA PARAFUSOS SEXTAVADOS

→ ISO 1173 - ISO 691 - ISO 1711-1

→ Manutenção do parafuso por ímã.



	A mm	L mm	Peso g	☒	EAN
E113643	7	65	45	24	3258951136430
E113644	8	65	45	24	3258951136447
E113645	9	65	45	24	3258951136454
E113646	10	65	51	24	3258951136461
E131608	13	65	46	24	3258951316085



PORTA-PONTAS E ACESSÓRIOS

CHAVE DE PARAFUSOS PORTA-PONTAS 1/4"

→ ISO 1173 - DIN 3126

→ Punho vulcanizado na lâmina: extremamente fiável e durável.

Punho soft grip anti-derrapante.

→ Punho soft grip anti-derrapante.

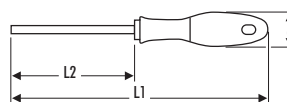

	L1 mm	L2 mm	d mm	Peso g	☒	EAN
E165490	230	125	32	130	5	3258951654903

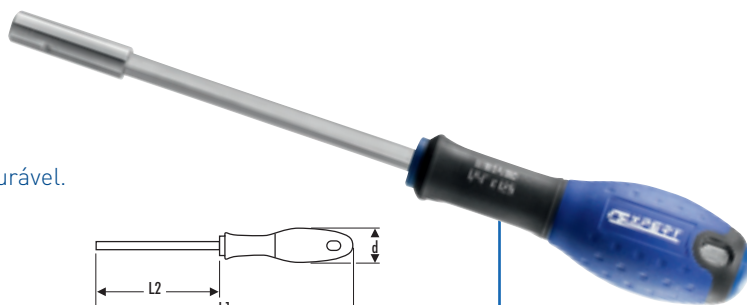

MINI PORTA-PONTAS DE ROQUETE 1/4"

→ ISO 1173

	L mm	Peso g	☒	EAN
E131601	91	54	20	3258951316016





CAIXA DE APARAFUSAMENTO 1/4" COM CHAVE REVÓLVER – 59 PEÇAS

- Chaves porta-pontas revólver de roquete (E160802).
- Pontas de fenda: 3 – 4x3 – 4,5 – 5 – 5,5x2 – 6 – 6,5x2 – 8 mm.
- Pontas Phillips®: PH1x3 – PH2x4 – PH3.
- Pontas Pozidriv®: PZ1x3 – PZ2x3 – PZ3.
- Pontas sextavadas: 2x2 – 3 – 4x2 – 5x2 – 6x2 mm.
- Pontas Torx®: T10 – T15x2 – T20x2 – T25x2 – T30x2 – T40x2.
- Pontas Resistorx®: TT10 – TT15x2 – TT20x2 – TT25x2 – TT30x2 – TT40.



E160804	Peso g	📦	EAN
891	1	3258951608043	

CHAVE DE PARAFUSOS PORTA-PONTAS PUNHO GIRATÓRIO COM ROQUETE

- Chave de parafusos porta-pontas revólver de roquete.
- Recipiente 6 pontas.
- Abertura através da pressão simultânea de 2 botões.
- 2 posições de aperto: tradicional e posição revólver para uma potência de aperto dez vezes maior.
- Fornecido com: Fenda: 4-5,5-6 mm, Philips®: PH1-PH2, Pozidriv®: PZ1-PZ2.



E160802	Sextavadas "	Peso g	📦	EAN
1/4	320	10	3258951608029	





PORTA-PONTAS E ACESSÓRIOS

CHAVE DE PARAFUSOS PORTA-PONTAS DE ROQUETE

- Recipiente 6 pontas.
- Abertura através da pressão simultânea de 2 botões.
- Fornecido com: Fenda: 4-5,5-6,5 mm, Philips®: PH1-PH2, Pozidriv®: PZ1-PZ2.



E160801	1/4	Peso g	10	EAN
		300		3258951608012



MINI-CHAVE DE PARAFUSOS PORTA-PONTAS DE ROQUETE

- Entregue com 1 recipiente de 3 ponteiras:
- Fenda: 5,5 mm.
- Philips®: PH2.
- Pozidriv®: PZ2.



E160803	1/4	Peso g	10	EAN
		170		3258951608036



CHAVE PORTA-PORTAS TURN 6

- Cabo em acetato de celulose transparente.
- Cabo de fixação directa com a ponta, evitando qualquer perda de potência aquando dos apertos grandes.
- Lâmina niquelada equipada com um adaptador magnético cromado.
- Tampão em elastómero.
- Entregue com: Fenda: 4,5-6,5, Philips®: PH1-PH2, Pozidriv®: PZ1-PZ2.



E161115	Peso g	1	EAN
	200		3258951611159





CHAVE PORTA-LÂMINAS

- Cabo porta-pontas em acetato.
- Mandril em latão.
- Lâminas redondas niqueladas.
- E161113 vem com: slot de 3,5 a 5,0, PH1, 1 ponto.



	L mm	Peso g	☒	EAN
E161112	135	28	1	3258951611128
E161113	155	58	1	3258951611135

PORTA-PONTAS COM BLOQUEIO 1/4"

→ ISO 1173



	L mm	Peso g	☒	EAN
E168733	60	28	20	3258951687338

PORTA-PONTAS MAGNÉTICO 1/4"

→ ISO 1173



	L mm	Peso g	☒	EAN
E113648	60	22	20	3258951136485
E131609	120	41	1	3258951316092

PORTA-CHAVES DE CAIXA 1/4"

→ ISO 1173 - ISO 1174-1



	L mm	Peso g	☒	EAN
E113649	50	29	24	3258951136492



APERTO CONTROLADO





Chaves dinamométricas

P.138

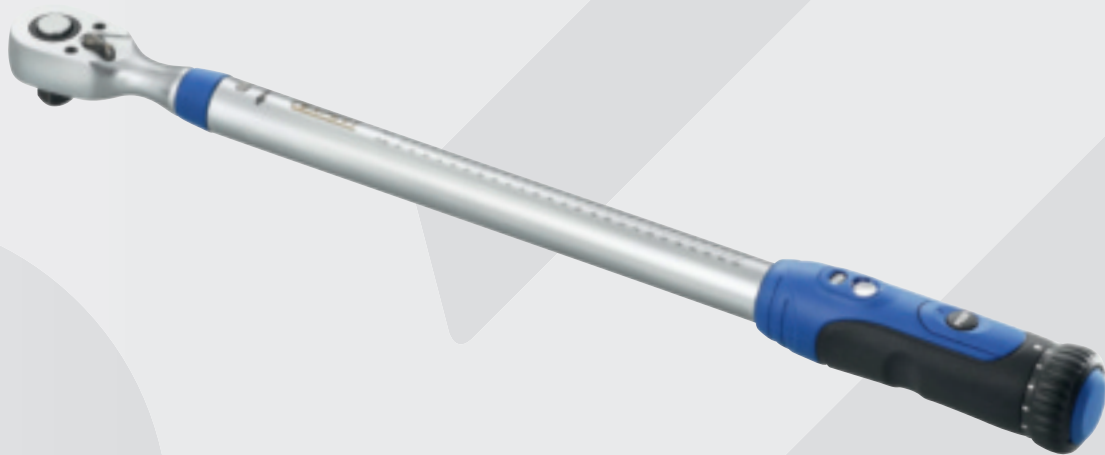

Multiplicadores de binário

P.139





CHAVES DINAMOMÉTRICAS

CHAVES DINAMOMÉTRICAS

- ISO 6789
- Precisão: +/- 4%.
- Pega confortável.
- Leitura direta do valor de binário.
- Rápida e fácil de regular.
- Resistência comprovada.
- Entregue com certificado de aferição.

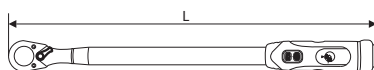

	▣	N.m	L mm	Peso g	☒	EAN
E100105	1/4"	5 - 25	323	760	1	3258951001059
E100106	3/8"	10 - 50	400	988	1	3258951001066
E100107	1/2"	20 - 100	400	988	1	3258951001073
E100108	1/2"	40 - 200	517	1360	1	3258951001080
E100109	1/2"	60 - 340	620	1730	1	3258951001097
E100110	3/4"	150 - 750	1200	5850	1	3258951001103



KITS DE REPARAÇÃO DE ROQUETES

- E100501: para chave dinamométrica 1/4" E100105.
- E100502: para chaves dinamométricas 3/8" E100106.
- E100503: para chaves dinamométricas 1/2" E100108, E100111, E100112 e E100113.
- E100504: para chave dinamométrica 3/4" E100110.
- E100505: para chave dinamométrica 1/2" E100107.
- E100506: para chave dinamométrica 1/2" E100109.



	☒	EAN
E100501	1	3258951005019
E100502	1	3258951005026
E100503	1	3258951005026
E100504	1	3258951005026
E100505	1	3258951005040
E100506	1	3258951005040

MULTIPLICADORES DE BINÁRIO

MULTIPLICADORES DE BINÁRIO

- Excelente aperto e desaperto.
- Casquilho fusível.
- Um braço de bloqueio direito.
- Um braço de bloqueio a 90°.



	☒	Ratio	N.m. entrada	N.m. saída	Peso g	☒	EAN
E100103	1/2" x 3/4"	6,5	231	1500	6200	1	3258951001035
E100104	1/2" x 1"	12	208	2500	8600	1	3258951001042

CASQUILHOS FUSÍVEIS

	N.m	Peso g	☒	EAN
E100203	1500	70	1	3258951002032
E100204	2500	70	1	3258951002049



FERRAMENTAS ENERGIZADAS





Chaves de impacto

P.142



Berbequins reversíveis

P.144



Retificadora direita

P.145



Lixadora

P.146



Pistola pneumática de rebitar

P.146



Roquete pneumático

P.146



Chaves de caixa de impacto 3/8"

P.148



Chaves de caixa de impacto 1/2"

P.148



Chaves de caixa de impacto 3/4"

P.153



Chaves de caixa de impacto 1"

P.156





CHAVES DE IMPACTO

CHAVES DE IMPACTO 1/2" COMPACTAS

- Construção compacta para aceder às zonas de acesso difícil.
- Binário: 678 N.m no desaperto.
- Revestimento de borracha na pega.
- Gatilho progressivo.
- Regulação de potência: 3.
- Rosca de ligação: 1/4".
- Tubo : 3/8" - 10 mm.



	Peso kg		EAN
E230104	1,6	1	3258952301042

CHAVES DE IMPACTO 1/2"

- Mecanismo de pancada com martelos geminados.
- Binário: 814 N.m no desaperto.
- Revestimento de borracha na pega.
- Gatilho progressivo.
- Regulação de potência: 5.
- Rosca de ligação: 1/4".
- Tubo: 3/8" - 10 mm.



	Peso kg		EAN
E230110	2,7	1	3258952301103

SUPORTE MAGNÉTICO PARA CHAVES DE IMPACTO 1/2"

- 4 ganchos para colocar chaves de caixa até ao quadrado 1/2".
- Anel para chave de impactos.
- Suporte para chave dinamométrica ou roquete.



		EAN
E231015	1	3258952310150



CHAVES DE IMPACTO 3/4" - 1017 N.M

- Mecanismo de pancada com martelos geminados.
- Binário: 1.017 N.m no desaperto.
- Revestimento de borracha na pega.
- Gatilho progressivo.
- Regulação de potência: 5.
- Rosca de ligação: 1/4".
- Tubo: 3/8" - 10 mm.



	Peso kg		EAN
E230115	2,9	1	3258952301158

CHAVE DE IMPACTO 3/4" - 1400 N.M

- Mecanismo de pancada com martelo geminado robusto.
- Binário: 1400 N.m no desaperto.
- O revestimento de borracha na pega permite um trabalho confortável e protege contra o frio.
- Escape pela pega.
- Gatilho progressivo.
- Inversor de acesso fácil que integra 3 níveis de potência no aperto.
- Diâmetro do tubo: 3/8" - 10 mm.
- Ligação ferramenta: 1/4".



	Peso kg		EAN
E230116	4,75	1	3258952301165

CHAVE DE IMPACTO 1"

- Mecanismo de pancada durável tipo pinless rocking dog.
- Binário: 2170 N.m no desaperto.
- Escape lateral.
- Gatilho progressivo.
- Inversor de acesso fácil que integra 3 níveis de potência no aperto.
- Diâmetro do tubo: 3/4" - 19 mm.
- Ligação ferramenta: 1/2".

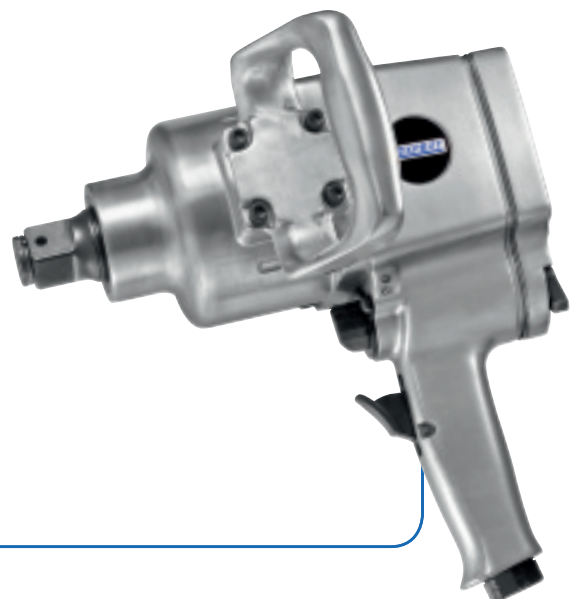

	Peso kg		EAN
E230120	12	1	3258952301202





CHAVES DE IMPACTO

CHAVES DE IMPACTOS 1"

- Mecanismo de pancada durável.
- Binário: 2170 N.m no desaperto.
- Revestimento de borracha na pega.
- Gatilho progressivo.
- Regulação de potência: 3.
- Rosca de ligação: 1/2".
- Tubo: 3/4" - 19 mm.



	Peso kg		EAN
E230125	9,8	1	3258952301257

CHAVE DE IMPACTO BARRA LONGA 1"

- Mecanismo de pancada durável tipo pinless rocking dog.
- Binário: 2170 N.m no desaperto.
- Escape lateral.
- Gatilho progressivo.
- Inversor de acesso fácil que integra 3 níveis de potência no aperto.
- Rosca de ligação 3/4" (19 mm).
- Peso: 9,8 kg.

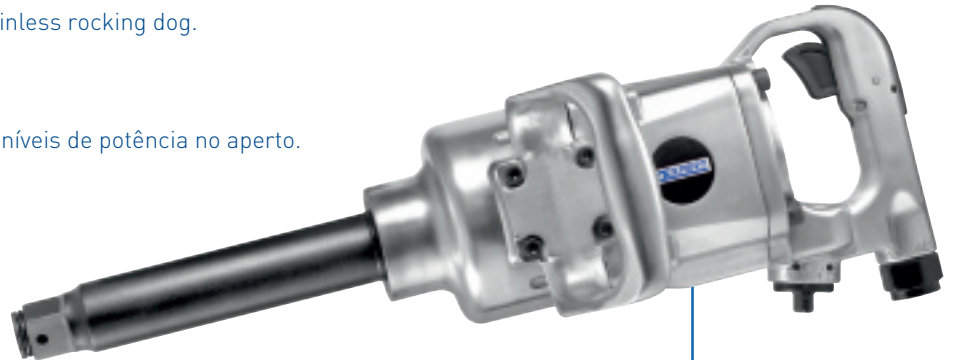

	Peso kg		EAN
E230126	9,8	1	3258952301257

BERBEQUINS REVERSÍVEIS

BERBEQUINS REVERSÍVEIS 3/8"

- Mandril de aperto rápido.
- Capacidade do mandril: 3/8" - 10 mm.
- Velocidade em vazio: 1 800 rpm.
- Potência: 0,3 kW.
- Diâmetro do tubo: 3/8" - 10 mm.
- Ligação ferramenta: 1/4".



	Peso kg		EAN
E230402	1,170	1	3258952304029



RETIFICADORA DIREITA

RETIFICADORA DIREITA 1/4"

- Velocidade em vazio: 25 000 rpm.
- Gatilho progressivo para um melhor controlo da velocidade.
- Diâmetro do tubo: 3/8" - 10 mm.
- Ligação ferramenta: 1/4".
- Potência: 0,3 kW.



E230502	Peso g	☒	EAN
E230502	562	1	3258952305026

RETIFICADORA ANGULAR COM PINÇA 1/4"

- Velocidade em vazio: 20.000 rpm.
- Gatilho progressivo para um melhor controlo da velocidade.
- Diâmetro do tubo: 3/8" - 10 mm.
- Ligação ferramenta: 1/4".
- Potência: 0,25 kW.



E230503	Peso g	☒	EAN
E230503	502	1	3258952305033

RODA DIAM.125 - M14"

- Velocidade de carga: 11000 r / min.
- Gatilho de segurança.
- Alimentação: 0,75 kW.
- Diâmetro do tubo: 3/8" - 10 mm.
- Ferramenta Log: 1/4".



E230508	Peso kg	☒	EAN
E230508	1,90	1	3258952305088





LIXADORA

LIXADORA ORBITAL 15 MM - 5 MM

- Velocidade em vazio: 10.000 rpm.
- Velocidade variável através de gatilho.
- Escape de ar rotativo a 360°
- Diâmetro do tubo: 3/8" - 10 mm.
- Ligaçao de ferramenta: 1/4".



	Peso kg		EAN
E230603	0,65	1	3258952306030

PISTOLA PNEUMÁTICA DE REBITAR

PISTOLA PNEUMÁTICA DE REBITAR

- Para rebites de 2,4-3,2-4,0-4,8 mm.
- Para uma utilização com aço, alumínio, cobre ou outros materiais moles.
- Força de tração: 9 kN.
- Gatilho grande para facilitar a utilização.
- Curso da ferramenta: 14 mm.
- Diâmetro do tubo: 3/8" - 10 mm.
- Ligaçao ferramenta: 1/4".



	Peso kg		EAN
E230901	1,720	1	3258952309017

ROQUETE PNEUMÁTICO

ROQUETE PNEUMÁTICO "MINI" 1/4"

- Design compacto para trabalhar num ambiente confinado.
- Velocidade em vazio: 250 rpm.
- Binário máximo: 27 N.m.
- Escape lateral.
- Inversão fácil na cabeça do roquete.
- Diâmetro do tubo: 1/4" - 6 mm.
- Ligaçao ferramenta: 1/4".



	L mm	d mm	Peso kg		EAN
E230201	175,5	36	0,52	1	3258952302018



ROQUETE PNEUMÁTICO "MINI" 3/8"

- Design compacto para trabalhar num ambiente confinado.
- Velocidade em vazio: 250 rpm.
- Binário máximo: 54 N.m.
- Escape lateral.
- Inversão fácil na cabeça do roquete.
- Diâmetro do tubo: 1/4" - 6 mm.
- Ligaç o ferramenta: 1/4".



	L mm	d mm	Peso kg	☒	EAN
E230202	175,5	36	0,52	1	3258952302025

ROQUETE PNEUMÁTICO 3/8"

- Mecanismo robusto para uma utiliza o di ria.
- Velocidade em vazio: 150 rpm.
- Bin rio m ximo: 68 N.m.
- Escape lateral.
- Invers o f cil na cabe a do roquete.
- Di metro do tubo: 3/8" - 10 mm.
- Liga o ferramenta: 1/4".



	L mm	L1 mm	d mm	Peso kg	☒	EAN
E230203	267	110,8	40,5	1,17	1	3258952302032

ROQUETE PNEUMÁTICO 1/2"

- Mecanismo robusto para uma utiliza o di ria.
- Velocidade em vazio: 150 rpm.
- Bin rio m ximo: 68 N.m.
- Escape lateral.
- Invers o f cil na cabe a do roquete.
- Di metro do tubo: 3/8" - 10 mm.
- Liga o ferramenta: 1/4".



	L mm	L1 mm	d mm	Peso kg	☒	EAN
E230204	267	110,8	40,5	1,17	1	3258952302049





CHAVES DE CAIXA DE IMPACTO 3/8"

JOGO DE CHAVES DE CAIXA DE IMPACTO 3/8" - 9 PEÇAS

- Chaves de caixa de impacto 3/8": 8-9-10-11-12-13-14-17-19 mm.
- Fornecido com anéis e cavilhas de segurança.
- Fornecido em expositor metálico.



		Peso kg		EAN
E041601	3/8"	1,30	1	3258950416014

CHAVES DE CAIXA DE IMPACTO 1/2"

ESTOJO DE CHAVES DE CAIXA LONGAS DE IMPACTO 1/2" - 14 PEÇAS

- Chaves de caixa longas de impacto sextavadas 1/2": 10-11-12-13-14-16-17-19-21-22-24-27-30-32 mm.
- Fornecido com anel e cavilhas de segurança.
- Fornecido em caixa com fechos metálicos, compatível com gaveta de carro.



		Peso kg		EAN
E041602	1/2"	4,65	1	3258950416021

ESTOJO DE CHAVES DE CAIXA E ACESSÓRIOS DE IMPACTO 1/2" - 17 PEÇAS

- Chaves de caixa de impacto sextavadas 1/2": 10-11-12-13-14-15-16-17-18-19-21-22-24-27-30-32 mm.
- Extensões de impacto 1/2" : 125 mm.
- Fornecido com anel e cavilhas de segurança.
- Fornecido em caixa com fechos metálicos, compatível com gaveta de carro.



		Peso kg		EAN
E041603	1/2"	3,80	1	3258950416038



MÓDULO DE ESPUMA DE CHAVES DE CAIXA CURTAS DE IMPACTO 1/2" - 11 PEÇAS

- Chave de impactos compacta 1/2".
- Chaves de caixa Impacto 1/2" - sextavadas - métricas: 11-12-13-17-19-21-22-24-27 mm.
- Extensão impacto 1/2": 125 mm.
- Conjunto de 5 anéis e 5 pinos para de chaves 1/2".
- E117884 : 8 -> 14 mm.
- E117881 : 15 -> 32 mm.
- Tabuleiro vazio: E231105.



E231101	1/2"	Peso g	1	EAN
		3,2		3258952311010

MÓDULO ESPUMA DE CHAVES DE CAIXA DE IMPACTO 1/2" - 10 PEÇAS

- Chave de impactos 1/2".
- Chaves de caixa longas impacto 1/2" - sextavadas - métricas: 13-16-17-18-19-21-22-24 mm.
- Extensão impacto 1/2": 125 mm.
- Conjunto de 5 anéis e 5 pinos para de chaves 1/2".
- E117884 : 8 -> 14 mm.
- E117881 : 15 -> 32 mm.
- Tabuleiro vazio: E231106.



E231102	1/2"	Peso kg	1	EAN
		5,2		3258952311027





CHAVES DE CAIXA DE IMPACTO 1/2"

MÓDULO DE CHAVES DE CAIXA E ACESSÓRIOS DE IMPACTO 1/2" - 26 PEÇAS

- Chaves de caixa de impacto sextavadas 1/2": 10-11-12-13-14-15-16-17-18-19-21-22-24 mm.
- Chaves de impacto Torx®: E10-E12-E14-E16-E18-E20-E24.
- Chaves de caixa de impacto longas para jantes de liga: 17-19-21 mm.
- 1 pack de 5 anéis de segurança e 5 cavilhas para chaves de caixa de impacto 1/2" 8 mm a 14 mm.
- 1 pack de 5 anéis de segurança e 5 cavilhas para chaves de caixa de impacto 1/2" 15 a 32 mm.
- 1 extensão de impacto 1/2" 125 mm.
- Tabuleiro: E041606.

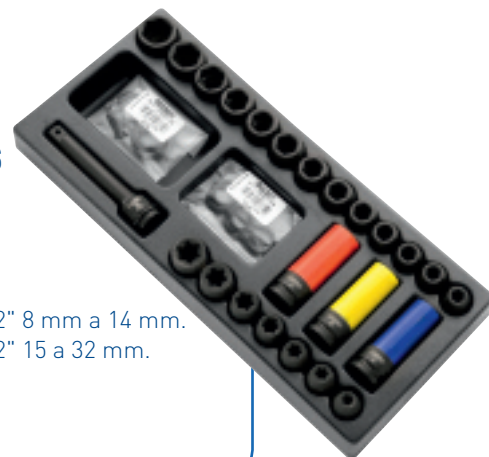

E041604	1/2"	Peso kg	1	EAN
		3,55		3258950416045

MÓDULO DE CHAVES DE CAIXA DE IMPACTO - 1/2" - 17 PEÇAS

- Chaves de caixa de impacto 1/2": 8-10-11-12-13-14-15-16-17-18-19-21-22-24 mm.
- 2 extensões de impacto 1/2": 50-250 mm.
- 1 cardan de impacto 1/2".
- Tabuleiro vazio: E040602.



E040601	1/2"	Peso kg	1	EAN
		2,35		3258950406015

MÓDULO DE CHAVES DE CAIXA DE IMPACTO 1/2" - 25 PEÇAS

- Chaves de caixa longas de impacto 1/2" sextavadas: 10-11-13-14-16-17-18-19-21-22-24-27-30-32 mm.
- 1 extensão de impacto 1/2" - 125 mm.
- Chaves de caixa aparafusadoras de impacto sextavadas 1/2": 5-6-8-10-12-14-17-19.
- 1 pack de 5 anéis de segurança e 5 cavilhas para chaves de caixa de impacto 1/2" 8 mm a 14 mm.
- 1 pack de 5 anéis de segurança e 5 cavilhas para chaves de caixa de impacto 1/2" 15 a 32 mm.
- Tabuleiro vazio: E041645.



E041644	1/2"	Peso kg	1	EAN
		5,24		3258950416441

JOGO DE CHAVES DE CAIXA DE IMPACTO TORX® 1/2" - 7 PEÇAS

- Chaves de caixa de impacto Torx 1/2": E10-E12-E14-E16-E18-E20-E24.
- Fornecido em expositor metálico.



E041605	1/2"	Peso kg	1	EAN
		0,7		3258950416052



CHAVES DE CAIXA DE IMPACTO 1/2"

EXTENSÕES DE IMPACTO 1/2"

- Especialmente estudada para resistir às tensões das máquinas de choques.
- Aço de cromo Molibdénio.
- Para sua segurança, utilize as extensões de impacto com os anéis e cavilhas adaptadas.

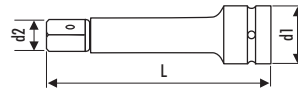

	L mm	d2 mm	Peso g	☒	EAN
E113616	50	16	97	1	3258951136164
E113617	125	16	230	1	3258951136171
E113618	250	16	430	1	3258951136188

CHAVE DE CAIXA DE IMPACTO 1/2" PORTA-PONTEIRAS 1/2"

- Especialmente estudado para resistir às tensões das máquinas de choque.
- Aço de cromo Molibdénio.
- Para sua segurança, utilize as chaves de caixa de impacto com os anéis e cavilhas adaptadas.

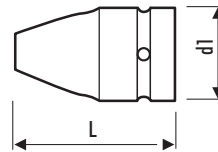

	L mm	Peso g	☒	EAN
E113619	40	90	1	3258951136195

CARDAN DE IMPACTO 1/2"

- Especialmente estudado para resistir às tensões das máquinas de choque.
- Aço de cromo Molibdénio.
- Para sua segurança, utilize as chaves de caixa de impacto com os anéis e cavilhas adaptadas.

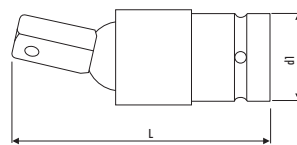

	L mm	Peso g	☒	EAN
E113620	60	170	1	3258951136201

1 PACK DE 5 CAVILHAS METÁLICAS E 5 ANÉIS PARA CHAVES DE CAIXA DE IMPACTO 1/2"

- E117884 para chaves de caixa de 8 a 14 mm.
- E117881 para chaves de caixa de 15 a 32 mm.



	Peso g	☒	EAN
E117881	5	1	3258951178812
E117884	6	1	3258951178843





CHAVES DE CAIXA DE IMPACTO 1/2"

CHAVES DE CAIXA DE IMPACTO 1/2" MÉTRICAS - SEXTAVADAS

- Especialmente estudada para resistir às tensões das máquinas de choques.
- Aço de cromo Molibdénio.
- Para sua segurança, utilize as extensões de impacto com os anéis e cavilhas adaptadas.



	A mm	L mm	d1 mm	d2 mm	Peso g	☒	EAN
E113489	8	38	25	15	86	1	3258951134894
E113490	10	38	25	17.5	87	1	3258951134900
E113491	11	38	25	18.7	89	1	3258951134917
E113492	12	38	25	20	89	1	3258951134924
E113493	13	38	25	21.3	88	1	3258951134931
E113494	14	38	25	22.5	88	1	3258951134948
E113495	15	38	30	23.7	136	1	3258951134955
E113496	16	38	30	25	138	1	3258951134962
E113497	17	38	30	26.2	133	1	3258951134979
E113498	18	38	30	27.5	134	1	3258951134986
E113499	19	38	30	28.7	128	1	3258951134993
E113588	21	38	30	30	120	1	3258951135884
E113589	22	38	30	32	160	1	3258951135891
E113592	24	45	30	35	177	1	3258951135921
E113594	27	50	30	38	222	1	3258951135945
E113596	30	50	30	42	240	1	3258951135969
E113597	32	50	30	44	244	1	3258951135976

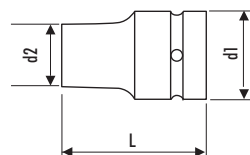

CHAVES DE CAIXA LONGAS DE IMPACTO 1/2" MÉTRICAS - SEXTAVADAS

- Especialmente estudada para resistir às tensões das máquinas de impacto.
- Aço de cromo Molibdénio.
- Para sua segurança, utilize as extensões de impacto com os anéis e cavilhas adaptadas.



	A mm	L mm	d1 mm	d2 mm	Peso g	☒	EAN
E113598	10	78	25	17.5	139	1	3258951135983
E113599	11	78	25	18.7	147	1	3258951135990
E113600	13	78	25	21.3	165	1	3258951136003
E113605	14	78	25	22.5	168	1	3258951136058
E113606	16	78	30	25	238	1	3258951136065
E113607	17	78	30	26.2	238	1	3258951136072
E113608	18	78	30	27.5	252	1	3258951136089
E113609	19	78	30	28.7	252	1	3258951136096
E113610	21	78	30	31	272	1	3258951136102
E113611	22	78	30	32	279	1	3258951136119
E113612	24	78	30	35	325	1	3258951136126
E113613	27	78	30	38	384	1	3258951136133
E113614	30	78	30	42	411	1	3258951136140
E113615	32	78	30	44	427	1	3258951136157

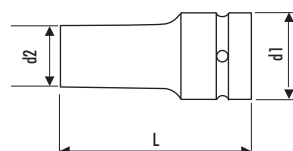



CHAVES DE CAIXA HEXAGONAIS DE IMPACTO 1/2"

- Especialmente estudada para resistir às tensões das máquinas de impacto.
- Aço de cromo Molibdénio.
- Chaves de caixa aparafusadoras monobloco.
- Para sua segurança, utilize os casquilhos de impacto com os anéis e cavilhas adaptadas.

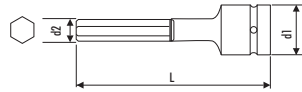

	A mm	L mm	d1 mm	d2 mm	Peso g	☒	EAN
E113623	5	75	25	6	84	1	3258951136232
E113624	6	75	25	7.1	89	1	3258951136249
E113625	8	75	25	9.5	97	1	3258951136256
E113626	10	75	25	11.8	108	1	3258951136263
E113627	12	75	25	14	125	1	3258951136270
E113628	14	75	25	16	143	1	3258951136287
E113629	17	75	25	19.8	178	1	3258951136294
E113630	19	75	25	22.1	203	1	3258951136300



CHAVES DE CAIXA DE IMPACTO 3/4"

MÓDULO DE ESPUMA DE CHAVES DE CAIXA CURTAS DE IMPACTO 3/4" - 11 PEÇAS

- Chave de impactos 3/4".
- Chaves de caixa de impacto 3/4" - métricas: 19-22-24-27-30-32-36-38 mm.
- Lote de 5 cavilhas metálicos e 5 anéis para chaves de caixa de impacto 3/4".
- Extensão impacto 3/4": 175 mm.



	☒	Peso g	☒	EAN
E231103	3/4"	8,1	1	3258952311034

CHAVES DE CAIXA DE IMPACTO 3/4"

EXTENSÕES DE IMPACTO 3/4"

- Especialmente estudada para resistir às tensões das máquinas de impacto.
- Aço de cromo Molibdénio.
- Para sua segurança, utilize as extensões de impacto com os anéis e cavilhas adaptadas.

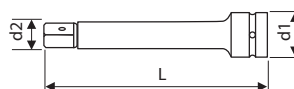

	L mm	d1 mm	d2 mm	Peso g	☒	EAN
E113487	175	44	25	883	1	3258951134870
E113488	250	44	25	1167	1	3258951134887



CHAVES DE CAIXA DE IMPACTO 3/4"

CARDAN DE IMPACTO - 3/4"

- Especialmente estudada para resistir às tensões das máquinas de impacto.
- Aço de cromo Molibdénio.
- Para sua segurança, utilize as extensões de impacto com os anéis e cavilhas adaptadas.

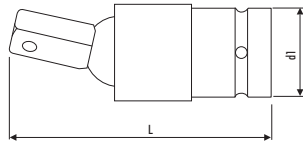

	L mm	d1 mm	Peso g		EAN
E041501	107	25.6	700	1	3258950415017



REDUTOR DE IMPACTO - 3/4" - 1/2"

- Especialmente estudada para resistir às tensões das máquinas de impacto.
- Aço de cromo Molibdénio.
- Para sua segurança, utilize os adaptadores de impacto com os anéis e cavilhas adaptadas.

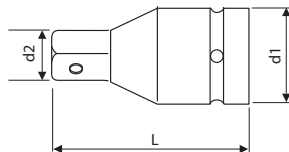

	L mm	d1 mm	d2 mm	Peso g		EAN
E041502	56	44	12.58	350	1	3258950415024



REDUTOR DE IMPACTO 1" - 3/4"

- Especialmente estudada para resistir às tensões das máquinas de impacto.
- Aço de cromo Molibdénio.
- Para sua segurança, utilize os adaptadores de impacto com os anéis e cavilhas adaptadas.

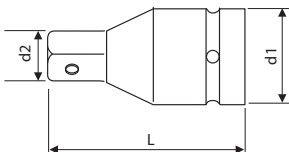

	L mm	d1 mm	d2 mm	Peso g		EAN
E041503	75	54	25	800	1	3258950415031



1 PACK DE 5 CAVILHAS METÁLICAS E 5 ANÉIS PARA CHAVES DE CAIXA DE IMPACTO 3/4"

- Para chaves de caixa 3/4" de 17 a 50 mm.

	Peso g		EAN
E113563	10,6	1	3258951135631

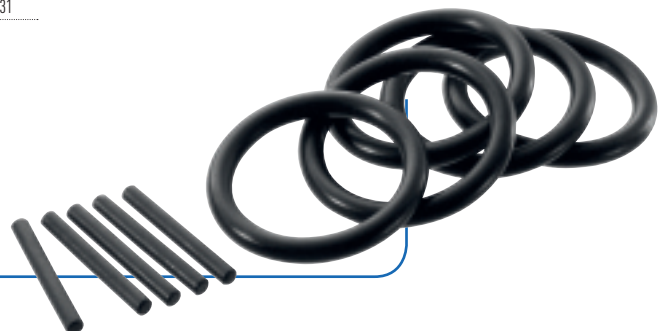



CHAVES DE CAIXA DE IMPACTO 3/4"

CHAVES DE CAIXA DE IMPACTO 3/4" MÉTRICAS

- Especialmente estudada para resistir às tensões das máquinas de impacto.
- Aço de cromo Molibdénio.
- Para sua segurança, utilize as extensões de impacto com os anéis e cavilhas adaptadas.

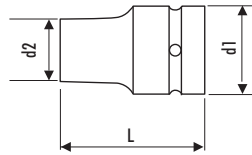

	A mm	L mm	d1 mm	d2 mm	Peso g	☒	EAN
E041101	17	38	30	26.2	367	1	3258950411019
E041102	19	38	30	28.7	367	1	3258950411026
E041103	21	38	30	30	367	1	3258950411033
E041104	22	38	30	32	367	1	3258950411040
E041105	24	45	30	35	400	1	3258950411057
E041106	27	50	30	38	400	1	3258950411064
E113470	30	50	30	42	429	1	3258951134702
E113471	32	50	30	44	475	1	3258951134719
E113472	33	56	44	51	481	1	3258951134726
E113473	34	56	44	52	492	1	3258951134733
E113475	36	56	44	54	523	1	3258951134757
E113476	38	58	44	57	565	1	3258951134764
E113477	41	58	44	60	608	1	3258951134771
E113479	46	63	44	67	770	1	3258951134795

CHAVES DE CAIXA DE IMPACTO LONGAS 3/4" MÉTRICAS

- Especialmente estudada para resistir às tensões das máquinas de impacto.
- Aço de cromo Molibdénio.
- Para sua segurança, utilize as extensões de impacto com os anéis e cavilhas adaptadas.

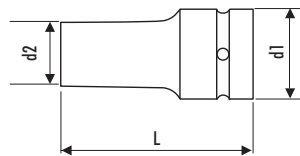

	A mm	L mm	d1 mm	d2 mm	Peso g	☒	EAN
E113480	17	95	44	31	541	1	3258951134801
E113481	19	95	44	33	566	1	3258951134818
E113482	24	95	44	39	634	1	3258951134825
E113483	27	95	44	43	705	1	3258951134832
E113484	30	95	44	47	734	1	3258951134849
E113485	32	95	44	49	829	1	3258951134856
E041301	33	95	44	52	800	1	3258950413013
E113486	36	95	44	54	930	1	3258951134863
E041302	41	95	44	60	1000	1	3258950413020
E041303	46	95	44	67	1200	1	3258950413037





CHAVES DE CAIXA DE IMPACTO 1"

JOGO DE CHAVES DE CAIXA LONGAS DE IMPACTO EM EXPOSITOR 1" - 4 PEÇAS

- Chaves de caixa longas de impacto 1" sextavadas – métricas
- Chaves de caixa: 27-32-33-36 mm.
- Entregue com fios metálicos e cavilhas de segurança.
- Entregue em expositor metálico (E042406).



E041648	1"	Peso g	1	EAN
		608		3258950416489

JOGO DE CHAVES DE CAIXA DE IMPACTO EM EXPOSITOR 1" - 8 PEÇAS

- Chaves de caixa impacto 1" sextavadas – métricas
- Chaves de caixa: 27-30-32-33-36-41-46-50 mm.
- Entregue com fios metálicos e cavilhas de segurança.
- Entregue em expositor metálico (E042408).



E041647	1"	Peso g	1	EAN
		1350		3258950416472

CHAVES DE CAIXA DE IMPACTO 1"

EXTENSÃO CHAVES DE CAIXA DE IMPACTO 1"

- ISO 1174-2
- Especialmente estudadas para resistir às tensões das máquinas de choques.
- Aço com cromo-molibdênio.
- Para sua segurança, utilize as suas extensões de impacto com os anéis e cavilhas adaptadas.

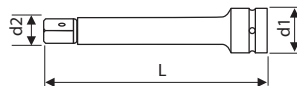

E042402	L mm	d1 mm	d2 mm	Peso g	1	EAN
	200	54	34	1626		3258950424026



LOTE DE 5 CAVILHAS METÁLICAS E 5 ANÉIS PARA CHAVES DE CAIXA DE IMPACTO 1"

→ Para chaves de caixa 1" de 19 a 70 mm.

E042401	Peso g	☒	EAN
	7	1	3258950424019

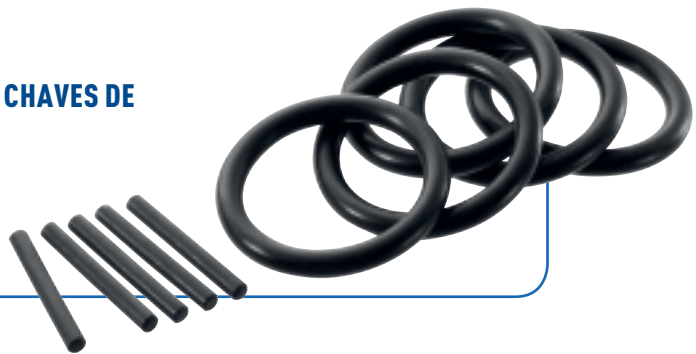

CHAVES DE CAIXA DE IMPACTO 1"

CHAVES DE CAIXA IMPACTO 1"

- ISO 2725-2 - ISO 1711-2 - ISO 1174-2
- Especialmente estudadas para resistir às tensões das máquinas de choques.
- Aço com cromo-molibdênio.
- Para sua segurança, utilize as chaves de caixa de impacto com os anéis e cavilhas adaptadas.

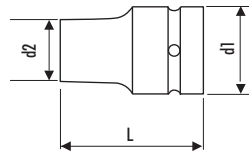

	A mm	L mm	d1 mm	d2 mm	Peso g	☒	EAN
E042204	27	58	50,9	44	500	1	3258950422046
E042207	30	60	50,9	48	540	1	3258950422077
E042208	32	60	50,9	50,9	570	1	3258950422084
E042209	33	62	52	52,9	630	1	3258950422091
E042211	36	62	52	55,9	650	1	3258950422114
E042213	41	62	52	61,5	700	1	3258950422138
E042215	46	64	58	68	980	1	3258950422152
E042216	50	70	58	73	1140	1	3258950422169

CHAVES DE CAIXA DE IMPACTO LONGAS 1"

- ISO 2725-2 - ISO 1711-2 - ISO 1174-2
- Especialmente estudadas para resistir às tensões das máquinas de choques.
- Aço com cromo-molibdênio.
- Para sua segurança, utilize as chaves de caixa de impacto com os anéis e cavilhas adaptadas.

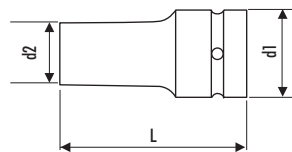

	A mm	L mm	d1 mm	d2 mm	Peso g	☒	EAN
E042304	27	90	50,9	44	740	1	3258950423043
E042307	32	90	50,9	50,9	900	1	3258950423074
E042308	33	90	52	52,9	940	1	3258950423081
E042310	36	90	52	55,9	1000	1	3258950423104

ALIGATES





Jogo de alicates mecânico

P.160



Alicates ajustáveis

P.162



Alicates universais

P.162



Alicates de corte

P.163



Alicates pontas

P.165



Alicates para freios circlips®

P.166



Turquesas

P.168



Alicates de Pressão

P.168



ALICATES 1000 VOLTS E ALICATES ELETRONICA

Ver secção eletricidade eletrônica p 212.

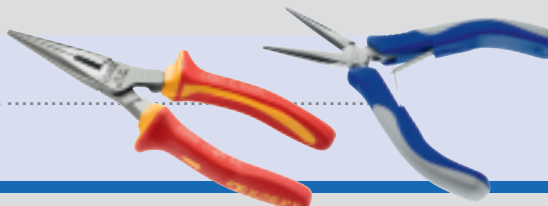



JOGO DE ALICATES MECÂNICO

JOGO DE 4 ALICATES PARA MECÂNICA

- Alicates universal 180 mm : E080504.
- Alicates de corte diagonal 160 mm : E080205.
- Alicates de pontas meio redondas direitas 200 mm : E080408.
- Alicates extensível 240 mm : E184690.
- Fabricado em França.



	Qde	Peso g		EAN
E080817	4	975	1	3258950808178

JOGO DE 4 ALICATES PARA MECÂNICO

- Alicates universal 180 mm : E080504.
- Alicates de corte diagonal 160 mm : E080205.
- Alicates de pontas meio redondas direitas 200 mm : E080408.
- Alicates ajustável 240 mm : E084648.
- Fabricado em França.



	Qde	Peso g		EAN
E080818	4	985	1	3258950808185

JOGO DE 2 ALICATES PARA MECÂNICO

- Alicates corte diagonal 160 mm : E080205.
- Alicates ajustável 240 mm : E184690.
- Fabricado em França.



	Qde	Peso g		EAN
E080815	2	558	1	3258950808154

JOGO DE 3 ALICATES PARA MECÂNICO

- Alicates universal 180 mm : E080504.
- Alicates de corte diagonal 160 mm : E080205.
- Alicates de pontas meio redondas direitas 200 mm : E080408.
- Fabricado em França.



	Qde	Peso g		EAN
E080816	3	730	1	3258950808161



JOGO DE 7 ALICATES E CHAVES DE FENDAS/PHILLIPS

- Alicates universal 180 mm : E080504.
- Alicates de corte diagonal 160 mm : E080205.
- Chave de fendas : 3,5 X 75 E164983.
- Chave de fendas : 4 X 100 E165017.
- Chave de fendas : 5.5 X 125 E165476.
- Chave Phillips : PH 1 X 100 E165207.
- Chave Phillips : PH 2 X 125 E165209.
- Fabricado em França.

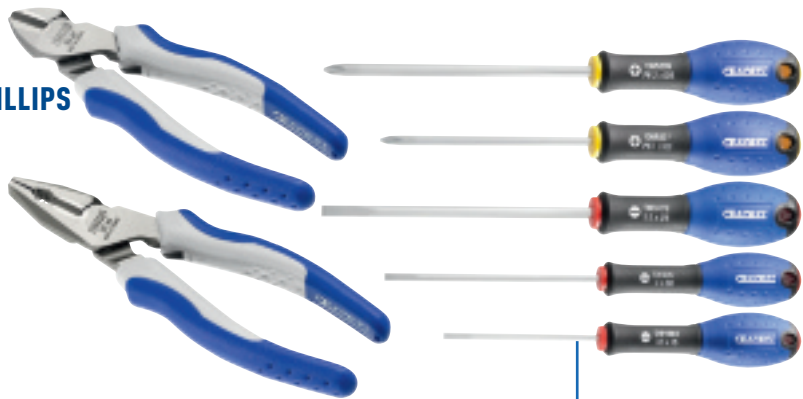

	Qde	Peso g	☒	EAN
E080819	7	2500	1	3258950808192

MODULES DE PINCES MÉCANICIEN

MÓDULO DE 4 ALICATES PARA MECÂNICA

- Alicates de corte diagonal de 160 mm: E080205
- Alicates universal 180 mm: E080504
- Alicates de descarnar 170 mm: E050106
- Alicates de pontas semirredondas retas de 200 mm: E080408
- Tabuleiro vazio: E010537.
- Fabricado em França.

	Qde	Peso g	☒	EAN
E080821	4	1246	1	3258950808215

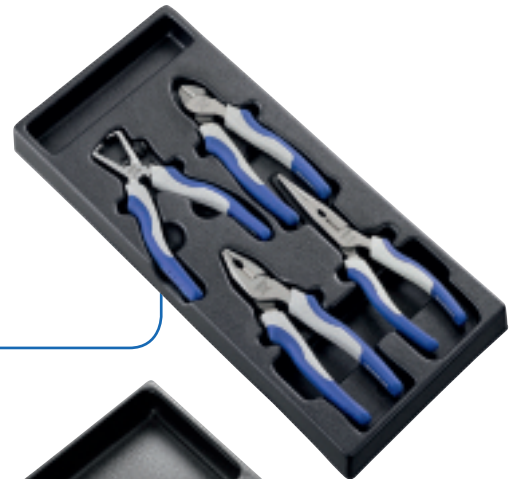

MÓDULO DE 2 ALICATES AJUSTÁVEL/PRESSÃO

- Tabuleiro em poliestireno.
- E080801 contém:
- 1 alicate ajustável: E184690.
- 1 alicate de pressão: E184199.
- Tabuleiro vazio: E010504.

	Qde	Peso g	☒	EAN
E080801	2	1370	1	3258950808017



MÓDULO DE ALICATES AJUSTÁVEL PRESSÃO

- O módulo E194944 contém:
- 1 alicate ajustável: E084648.
- 1 alicate de pressão mono-regulável de pontas curtas: E084809.
- Tabuleiro termoformado vazio: E010504.

	Qde	Peso g	☒	EAN
E194944	2	1264	1	3258951949443





ALICATES AJÚSTAVEIS

ALICATES AJÚSTAVEIS

- ISO 8976
- Multi-posições.
- Botão pushlock (patenteado).
- Cabo ergonómico bi-matéria.
- Acabamento: crómio preto.
- 17 posições.

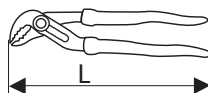

	L mm	Profundidade (mandíbulas) mm	Peso g		EAN
E084648	260	31.6	254	5	3258950846484
E084649	311	69.5	304	5	3258950846491

ALICATES AJÚSTAVEIS SOBREPOSTO - 240 MM

- ISO 8976
- Cabos espalmados.
- Revestimentos em PVC azul.
- Acabamento: forjado envernizado.

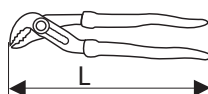

	L mm	Profundidade (mandíbulas) mm	Peso g		EAN
E184690	240	32.5	310	10	3258951846902

ALICATES UNIVERSAIS

ALICATE UNIVERSAL

- DIN ISO 5746
- Concebido para abranger todas as aplicações de preensão e corte. Extremidades de corte concebidas para cortar todos os tipos de cabos (macios, semi rígidos, rígidos).
- Pega ergonómica para um conforto superior em utilização prolongada e repetitiva.
- E080503 Corda de piano máx. 1,6 mm 220 kg/mm².
- E080504 Corda de piano máx. 1,8 mm 215 kg/mm².
- E080505 Corda de piano máx. 2,0 mm 210 kg/mm².
- Fabricado em França.

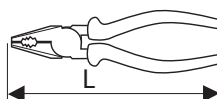

	L mm	Peso g		EAN
E080503	160	195	1	3258950805030
E080504	180	225	1	3258950805047
E080505	200	300	1	3258950805054



ALICATES DE CORTE

ALICATE DE CORTE PARA ELETRICIDADE

- **DIN ISO 5749**
- Modelo para eletricidade especificamente concebido para oferecer um acesso perfeito em espaços reduzidos.
- Extremidades de corte concebidas para garantir o melhor desempenho em cabos macios (cobre) e semi rígidos.
- Pega ergonómica para uma utilização confortável durante operações de corte repetitivas.
- E080208 Corda de piano máx. 1,4 mm 160 kg/mm².
- E080209 Corda de piano máx. 1,6 mm 160 kg/mm².
- E080210 Corda de piano máx. 1,8 mm 160 kg/mm².
- Fabricado em França.

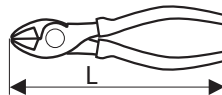

	L mm	Peso g		EAN
E080208	140	155	1	3258950802084
E080209	160	190	1	3258950802091
E080210	180	250	1	3258950802107

ALICATE DE CORTE PARA ENGENHARIA

- **DIN ISO 5749**
- Concebido para oferecer uma versatilidade perfeita independentemente da carga de corte.
- Extremidades de corte concebidas para garantir o melhor desempenho em cabos macios (cobre), semi rígidos e rígidos (aço inoxidável, mola).
- Pega ergonómica para uma utilização confortável durante operações de corte repetitivas.
- E080205 Corda de piano máx. 1,6 mm 220 kg/mm².
- E080206 Corda de piano máx. 1,8 mm 215 kg/mm².
- E080207 Corda de piano máx. 2,0 mm 210 kg/mm².
- Fabricado em França.

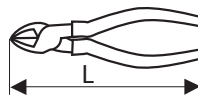

	L mm	Peso g		EAN
E080205	160	200	1	3258950802053
E080206	180	260	1	3258950802060
E080207	200	320	1	3258950802077

ALICATE DE CORTE FRONTAL - 160 MM

- **DIN ISO 5748**
- O design da extremidade de corte assegura um corte preciso de cabos rígidos e semi rígidos.
- Esforço de corte mínimo graças à alavanca mais longa.
- Pega ergonómica para um conforto superior em operações de corte repetitivas.
- Corda de piano máx. 1,6 mm 220 kg/mm².
- Fabricado em França.

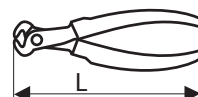

	L mm	Peso g		EAN
E080211	160	200	1	3258950802114





ALICATES DE CORTE

ALICATES DE CORTE DIAGONAL

- Corpo em aço com cromo-vanádio.
- Pontas polidas e cromadas para um corte preciso e eficiente.
- Revestimentos em PVC azul.

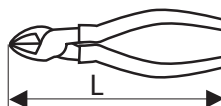

	L mm	Peso g		EAN
E020308	150	130	5	3258950203089
E020309	175	215	5	3258950203096

ALICATE DE CORTE DIAGONAL OBLÍQUO

- Corpo em aço com cromo-vanádio.
- Pontas polidas e cromadas para um corte preciso e eficiente.
- Revestimentos em PVC azul.

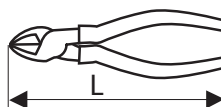

	L mm	Peso g		EAN
E020310	150	127	2	3258950203102

ALICATES PONTAS

PONTAS SEMI-REDONDAS - ALICATE CURVO DE 40°

- DIN ISO 5745
- Pontas finas para assegurar um ótimo acesso quando utilizado em espaços reduzidos (quadros elétricos).
- Pontas dentadas finas com cortador de cabos lateral - máx. 1,6 mm 160 kg/mm².
- Pega ergonômica para um conforto superior em utilização prolongada e repetitiva.
- Fabricado em França

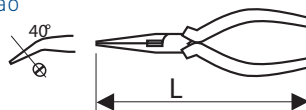

	L mm	Peso g		EAN
E080409	160	177	1	3258950804095
E080410	200	192	1	3258950804101



ALICATES PONTAS

ALICATE PLANO - PONTAS RETAS - 160 MM

- DIN ISO 5745
- Pontas ligeiramente dentadas para uma preensão perfeita.
- Pega ergonómica para um conforto superior.
- Fabricado em França.

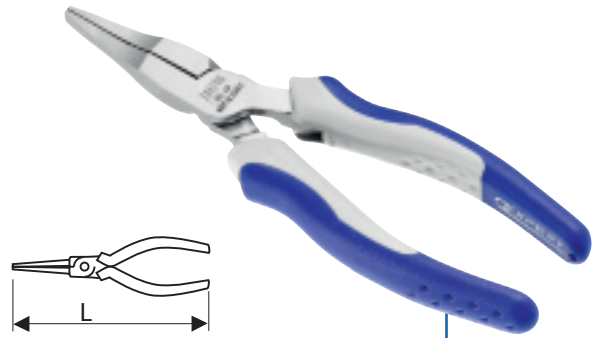

	L mm	Peso g		EAN
E080411	160	140	1	3258950804118

ALICATE DE PONTAS REDONDAS 170 MM

- DIN ISO 5745
- Ideal para formar círculos, dobras ou arcos.
- Pega ergonómica para um conforto superior.
- Fabricado em França.



	L mm	Peso g		EAN
E080412	170	135	1	3258950804125

ALICATE DE PONTAS DIREITAS LONGAS

- DIN ISO 5745
- Pontas finas para assegurar um ótimo acesso quando utilizado em espaços reduzidos (quadros elétricos).
- Pontas dentadas finas com cortador de cabos lateral - máx. 1,6 mm 160 kg/mm².
- Pega ergonómica para um conforto superior em utilização prolongada e repetitiva.
- Fabricado em França



	L mm	Peso g		EAN
E080407	160	177	1	3258950804071
E080408	200	192	1	3258950804088





MÓDULO DE ALICATES PARA FREIOS

MÓDULO DE 4 ALICATES CIRCLIPS®

- 1 alicate de fechar à direita: E117914.
- 1 alicate de fechar pontas a 90°: E117922.
- 1 alicate de abrir à direita: E117910.
- 1 alicate de abrir pontas a 90°: E177918.
- Tabuleiro vazio: E010503.



	Qde	Peso g		EAN
E194943	4	1052	1	3258951949436

ALICATES PARA FREIOS CIRCLIPS®

CONJUNTO DE 4 ALICATES CIRCLIPS®

- Alicates interno reto: E117914.
- Alicates interno de 90°: E117922.
- Alicates externo reto: E117910.
- Alicates externo de 90°: E177918.
- Embalagem de retalho.

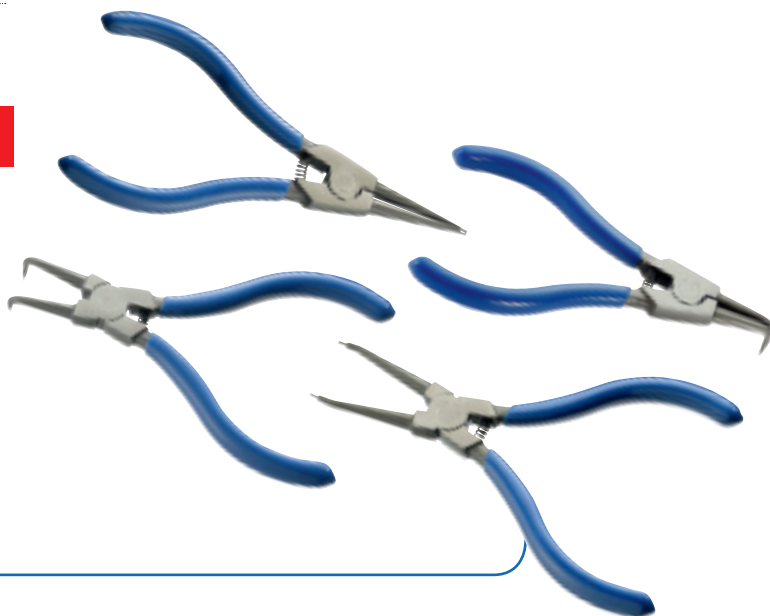

	Peso g maxi		EAN
E080820	785	1	3258950808208

ALICATES PARA FREIOS CIRCLIPS® - DE FECHAR PONTAS DIREITAS

- DIN 5256 - NF E 73-130
- Pontas maquinadas que permitem um posicionamento perfeito do freio.
- Revestimento PVC azul.

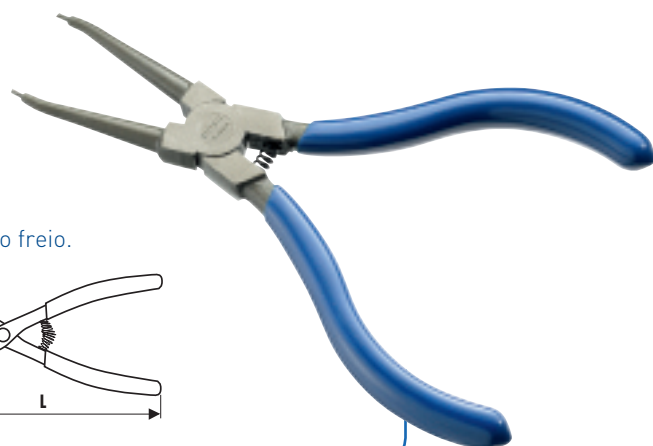
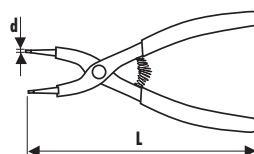

	d mm**	L mm	Circlips mini-maxi mm	Peso g		EAN
E117912	0.9	140	3-10	95	10	3258951179123
E117913	1.3	145	10-25	100	10	3258951179130
E117914	1.8	185	19-60	140	10	3258951179147
E117915	2	215	40-100	330	10	3258951179154



ALICATES PARA FREIOS CIRCLIPS® - DE FECHAR PONTAS A 90°

- DIN 5256 - NF E 73-130
- Pontas maquinadas que permitem um posicionamento perfeito do Circlips®.
- Revestimento PVC azul.

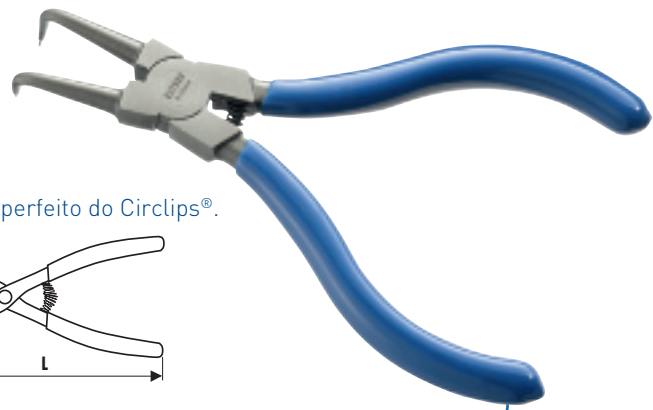
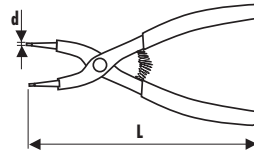

	d mm**	L mm	Circlips mini-maxi mm	Peso g	☒	EAN
E117920	0.9	130	3-10	95	10	3258951179208
E117921	1.3	130	10-25	100	10	3258951179215
E117922	1.8	170	19-60	150	10	3258951179222
E117923	2	275	40-100	330	10	3258951179239

ALICATES CIRCLIPS® - DE ABRIR, PONTAS DIREITAS

- DIN 5254 - NF E 73-130
- Pontas maquinadas que permitem um posicionamento perfeito do Circlips®.
- Revestimento PVC azul.

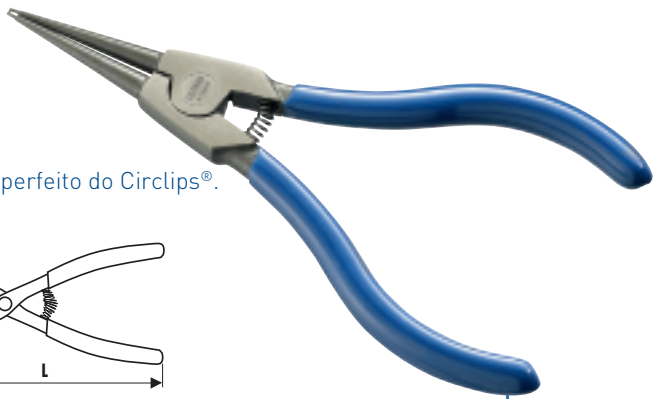
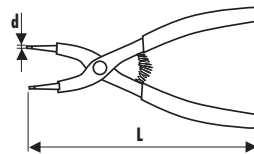

	d mm**	L mm	Circlips mini-maxi mm	Peso g	☒	EAN
E117908	0.9	150	3-10	95	10	3258951179086
E117909	1.3	150	10-25	100	10	3258951179093
E117910	1.8	180	19-60	160	10	3258951179109
E117911	2	180	40-100	330	10	3258951179116

ALICATES PARA FREIOS CIRCLIPS® - DE ABRIR PONTAS CURVAS A 90°

- DIN 5254 - NF E 73-130
- Pontas maquinadas que permitem um posicionamento perfeito do Circlips®.
- Revestimento PVC azul.

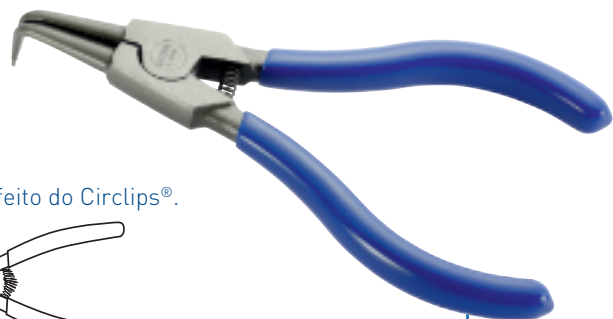
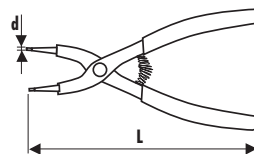

	d mm**	L mm	Circlips mini-maxi mm	Peso g	☒	EAN
E117916	0.9	140	3-10	95	10	3258951179161
E117917	1.3	140	10-25	105	10	3258951179178
E117918	1.8	170	19-60	150	10	3258951179185
E117919	2	200	40-100	330	10	3258951179192





TURQUESAS

TURQUESAS RUSSAS

- ISO 9242
- Braço rígido semi-arredondado para uma manipulação facilitada.
- Cortantes tratados «HF» para uma longa duração de vida e desempenhos de corte acrescidos.
- Capacidade de corte máx: 4,5 mm para fio mole e fio duro 160 kg/mm².
- Acabamento brunido cabeça polida.

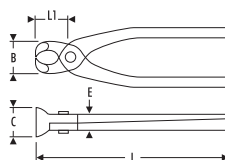

	B mm	C mm	L mm	L1 mm	Peso g	☒	EAN
E184179	28	12	200	10	265	10	3258951841792
E184302	31	13	220	10.5	325	10	3258951843024
E184181	35	14	250	12	425	10	3258951841815
E184182	35	14	280	12	495	10	3258951841822

ALICATES DE PRESSÃO

ALICATES DE PRESSÃO MONO-REGULÁVEIS MORDENTES CURTOS

- Corpo cromado anti-corrosão.
- Mordentes maquinados com precisão.
- Estrias em toda a profundidade do mordente.
- Potência de aperto regulável por manípulo.
- Alavanca de desbloqueio.

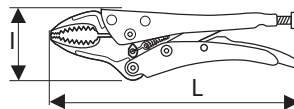

	L mm	l mm	Profundidade (mandíbulas) mm	Peso g	☒	EAN
E084807	140	47	23	205	5	3258950848075
E084808	190	60	34	415	5	3258950848082
E084809	250	75	50	659	5	3258950848099

ALICATES DE PRESSÃO MONO-REGULÁVEIS MORDENTES LONGOS

- Alicates de pressão mordentes longos que permite um acesso melhor e é ideal para os trabalhos mais delicados.
- Corpo cromado anti-corrosão.
- Mordentes maquinados com precisão. Estrias em toda a profundidade do mordente.
- Potência de aperto regulável por parafuso.
- Alavanca de desbloqueio.

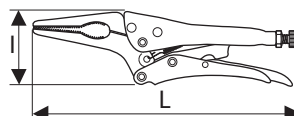

	L mm	l mm	Profundidade (mandíbulas) mm	Peso g	☒	EAN
E084812	170	47	51	227	5	3258950848129
E084813	235	56	66	450	5	3258950848136



ALICATES DE PRESSÃO LONGO ALCANCE

- Alicates de pressão «C».
- Garras especiais em aço forjado para garantir uma retenção perfeita dos perfis, ferro em U e cantoneiras.
- Corpo cromado anti-corrosão.
- Mordentes maquinados com precisão.
- Potência de aperto regulável por parafuso.
- Alavanca de desbloqueio.

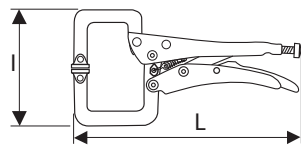

E084816



E084815

	L mm	l mm	Profundidade (mandíbulas) mm	Hauteur de machoir mm	Peso g	✉	EAN
E084815	170	88	37	58	265	5	3258950848150
E084816	290	150	65	100	890	5	3258950848167

ALICATE DE PRESSÃO GRANDE CAPACIDADE

- Alicates de pressão ideal para beneficiar de uma grande capacidade de fixação em superfícies redondas/quadradas e em cantos.
- Cremalheira de botão 4 posições.
- Corpo cromado.
- Alicates com acabamento em fosfato.
- Mordentes maquinados com precisão.
- Pontas de 17 mm de largura.

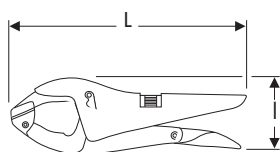

	L mm	l mm	Peso g	✉	EAN
E080701	250	63	620	1	3258950807010



MEDIÇÃO - TRAÇAGEM





Módulos

P.172



Níveis

P.173



Fita métrica

P.173



Paquímetro

P.174



Régua

P.174

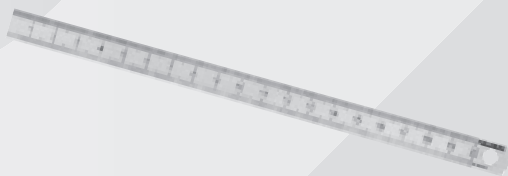

Riscador

P.174

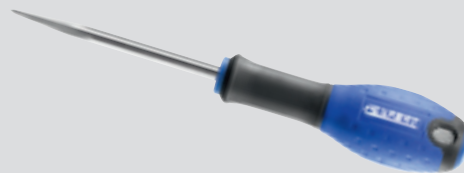

Riscador

P.175

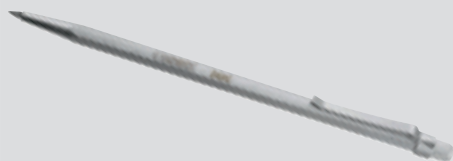



MÓDULOS

TESOURA AVIAÇÃO CORTE À DIREITA

- Tabuleiro termoformado.
- 1 alicate para rebitar 270 mm: E169804.
- 1 paquímetro mecânico 1/20 mm: E140601.
- 1 régua 200 mm: E140801.
- 1 punção automático Ø 7 mm: E150504.
- 1 riscador para traçagem em aço 190 mm: E003601.
- 1 tesoura aviação de corte à direita: E214563.
- Tabuleiro vazio: E142402.



	Quantité	Peso g		EAN
E142401	6	1513	1	3258951424018

MÓDULO CHAPARIA 2/3

- Contém:
- 1 alicate para rebitar 270 mm: E169804.
- 1 punção 4 mm: E150502.
- 1 ponteiro de traçar aço 190 mm: E003601.
- 1 régua 200 mm: E140801.
- 1 tesoura aviação de corte à direita: E214563.
- 1 serrote para metais - pega revólver: E115122.
- 1 fita métrica de dupla matéria: E140103.
- 1 x-ato 18 mm: E020302.
- 1 paquímetro mecânico 1/20 mm: E140601.
- Tabuleiro termoformado vazio: E010519.



	Quantité	Peso g		EAN
E090302	9	2305	1	3258950903026



NÍVEIS

NÍVEIS MAGNÉTICOS

- DIN 877
- Corpo em liga leve.
- 2 ímãs.



	Dimensions	Peso g	☒	EAN
E142301	300 x 50 x 20 mm	286	1	3258951423011
E142302	450 x 50 x 20 mm	364	1	3258951423028
E142303	600 x 50 x 20 mm	442	1	3258951423035



FITA MÉTRICA

FITAS MÉTRICAS

- Precisão de classe II.
- Caixa ergonômica cromada.
- Lâmina durável com revestimento em nylon.
- Fixação eficiente da lâmina.
- Clip para cinto em aço inoxidável.

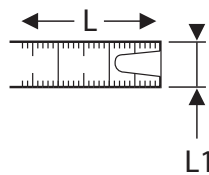

	L mm	L1 mm	Peso g	☒	EAN
E140105	3	13	90	1	3258951401057
E140106	5	19	200	1	3258951401064



PAQUÍMETRO

PAQUÍMETRO UNIVERSAL 1/20 - 0,05 MM

- DIN 862
- Precisão 1/20 - 0,05 mm.
- Capacidade de medição: 150 mm.
- Medida de interior, exterior e profundidade.
- Fornecido com capa de protecção com certificado de conformidade.

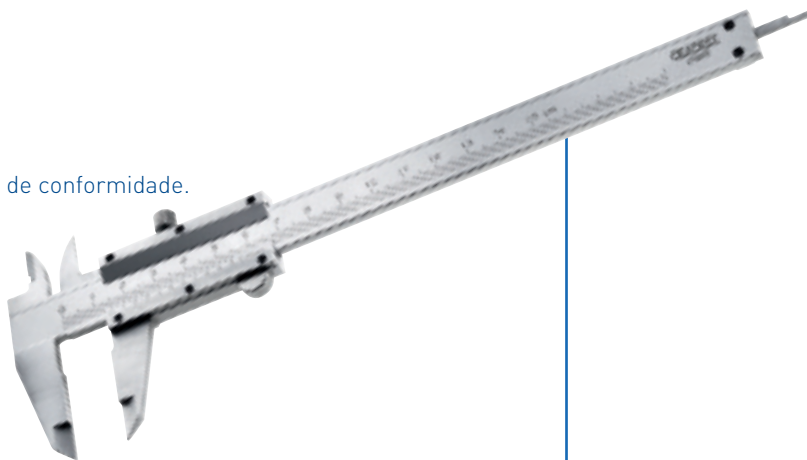

	L mm	Peso g		EAN
E140601	235	185	10	3258951406014

RÉGUA

RÉGUA FLEXÍVEL - 200 MM

- Gravação nas duas faces.
- mm e 1/2mm em cada face.



	L mm	Peso g		EAN
E140801	217	12	10	3258951408018

RISCADOR

PONTA QUADRADA

- Pega soft grip anti-derrapante.
- Lâmina redonda cromada.
- Ponta afiada.

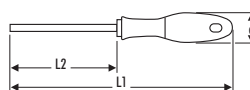

	L1 mm	L2 mm	d mm	Peso g		EAN
E161114	180	75	32	60	10	3258951611142



RISCADOR

RISCADOR COM PONTA EM CARBONETO - TIPO LÁPIS - 150 MM

- Ponteiro de traçar carboneto.
- Corpo hexagonal munido de um clip.
- Ponteira de afiar.
- Diâmetro 2,5 mm.



	L mm	Peso g		EAN
E140902	150	35	10	3258951409022

PONTEIROS DE TRAÇAR AÇO - 210 MM

- Corpo plástico.
- Diâmetro ponta: 0,4 mm.
- Diâmetro corpo: 8 mm.



	L mm	Peso g		EAN
E003601	190	20	10	3258950036014



MARTELOS





Modúlo ferramentas de pancada

P.178



Martelos

P.178



Malhos

P.180



Marretas

P.181



Martelos de Batentes - Maços

P.181



Ferramentas de pancada

P.182





MARTELOS

MODÚLO FERRAMENTAS DE PANCADA

MÓDULOS FERRAMENTAS DE PANCADA

- Contém:
- 1 martelo.
- 1 macete de 32 mm.
- 3 saca-troços de 4, 6 e 8 mm.
- 1 buril de perfil constante de 24 mm.
- 1 punção de 6 mm.
- E150801: Martelo de pena 32, referência: E154668 - tabuleiro vazio E010501.
- E150802: Martelo DIN, referência: E150103 - tabuleiro vazio E010506.
- E150803: Martelo de cabeça em forma de bola, referência E150107 - tabuleiro vazio E010507.



	Quantité	Peso g		EAN
E150801	1	1945	1	3258951508015
E150802	1	1911	1	3258951508022
E150803	1	1610	1	3258951508039

MARTELOS

MARTELOS DE PENA

- ISO 15601
- Cabeça dureza 50-58 HRC.
- Ligação cabeça-cabo por cunhagem.
- Cabo em nogueira americana.
- Cabeça abaulada.

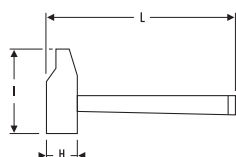

	H mm	L mm	l mm	Peso g		EAN
E154665	25	284	78.5	245	1	3258951546659
E154667	30	304	91.5	530	1	3258951546673
E154668	32	306	98	650	1	3258951546680
E154669	35	309	104	800	1	3258951546697
E154670	40	325	108.5	1020	1	3258951546703
E154672	45	355	126	1600	1	3258951546727
E154673	50	365	135.5	1900	1	3258951546734
E154674	55	370	141	2400	1	3258951546741



MARTELO DE PENA

- DIN 1041, ISO 15601
- Cabeça dureza 50-58 HRC.
- Cabo de freixo.
- Cunhagem cônica.

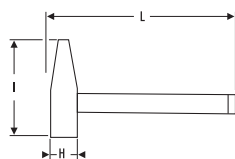

	H mm	L mm	L mm	Peso g	☒	EAN
E150101	19	280	95	300	1	3258951501016
E150102	23	300	105	410	1	3258951501023
E150103	27	320	120	625	1	3258951501030
E150104	33	350	130	960	1	3258951501047
E150105	36	360	135	1180	1	3258951501054

MARTELOS COM CABEÇA EM FORMA DE BOLA

- ASME B107.53
- Cabeça dureza 50-56 HRC.
- Cabo de hickory.
- Cunhagem através de cunha metal e cunha madeira.

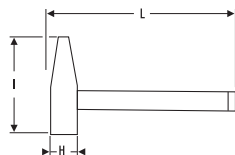

	d mm"	L mm	L mm	Peso g	☒	EAN
E150106	19	275	64	200	1	3258951501061
E150107	23.5	300	82.5	355	1	3258951501078
E150108	30.5	350	101.7	590	1	3258951501085
E150109	35.5	396	120	890	1	3258951501092
E150110	38.5	400	124.5	1110	1	3258951501108





MARTELOS

MARTELO DE COBRE

- Cabo de madeira.
- Cabeças em cobre e pele enrolada.

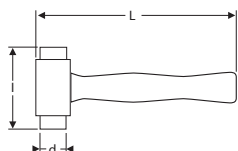

	d mm"	L mm	l mm	Peso g	☒	EAN
E151002	32	270	95	680	1	3258951510025
E151003	38	305	105	1135	1	3258951510032
E151004	44	305	120	1590	1	3258951510049



MALHOS

MAÇOS DE ARESTAS QUEBRADAS

- ISO 15601
- Cabeça dureza 50-58 HRC.
- Cabo de freixo.
- Cunhagem cônica.

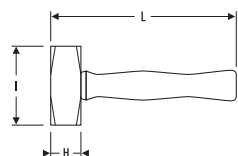

	H mm	L mm	l mm	Peso g	☒	EAN
E150111	40	260	95	1000	1	3258951501115
E150112	43	260	100	1250	1	3258951501122
E150113	45	280	110	1500	1	3258951501139
E150114	50	300	120	2000	1	3258951501146





MARRETAS

MAÇOS SEM RECOCHETE

- Material: borracha sintética SBR (styrene-butadiene rubber).
- Anti-ressalto graças a esferas de aço.
- Anti-vibração.
- Dureza cabeça shore A80-90.
- Cabo não amovível: monobloco.

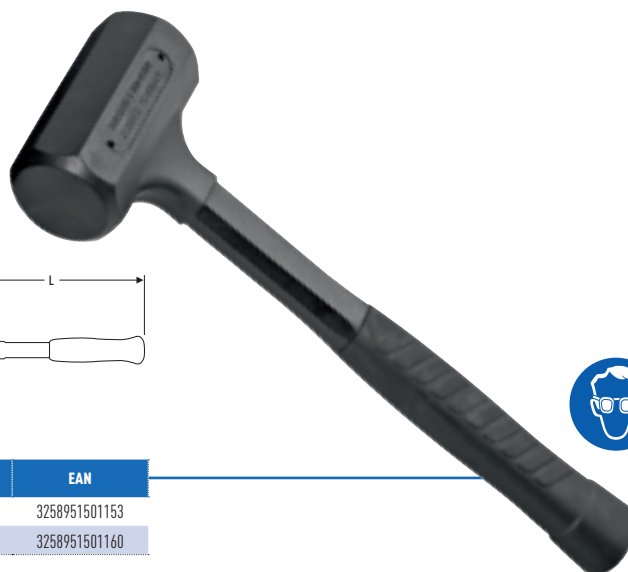
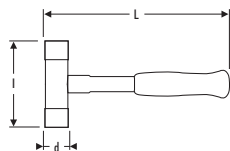

	d mm"	L mm	l mm	Peso g	☒	EAN
E150115	37,4	286	91,5	500	1	3258951501153
E150116	54	370	131,5	1370	1	3258951501160

MARTELOS DE BATENTES - MAÇOS

MARTELOS COM BATENTES INTERMUTÁVEIS

- Cabeça em liga de aço galvanizado.
- Cabo de madeira.
- 2 ponteiros em nylon.

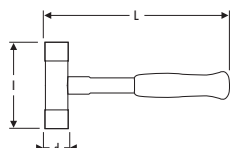

	d mm"	L mm	l mm	Peso g	☒	EAN
E150301	27	270	90	200	1	3258951503010
E150302	32	290	100	290	1	3258951503027
E150303	40	330	110	600	1	3258951503034
E150304	50	350	115	950	1	3258951503041

BATENTES INTERMUTÁVEIS EM NYLON

- Ponteiros nylon de dureza shore D66-85.
- Facilmente substituíveis.



	d mm"	Peso g	☒	EAN
E150305	27	20	1	3258951503058
E150306	32	33	1	3258951503065
E150307	40	48	1	3258951503072
E150308	50	60	1	3258951503089





FERRAMENTAS DE PANCADA

JOGO DE 6 SACA-TROÇOS

→ DIN 6450

→ 6 saca-troços de 2 a 8 mm.



	Quantité	Peso g		EAN
E418226	6	970	1	3258954182267

SACA-TROÇOS

→ Dureza 48-56 HRc para os diâmetros 2 a 4 mm e

50-58 HRc para os diâmetros 5 a 8 mm.

→ Monobloco para maior robustez e durabilidade.

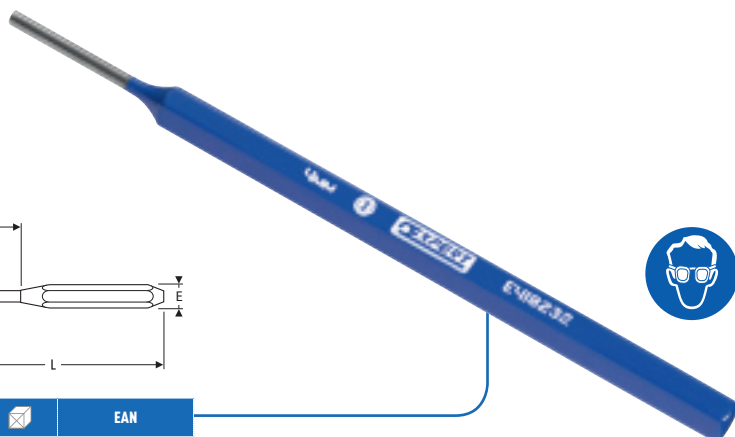
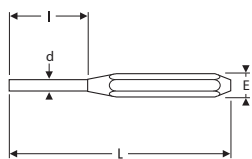

	d mm"	E mm	L mm	l mm	Peso g		EAN
E418230	2	6.3	152	25	35	1	3258954182304
E418231	3	7.9	152	35	52	1	3258954182311
E418232	4	7.9	152	40	55	1	3258954182328
E418233	5	7.9	152	45	55	1	3258954182335
E418234	6	9.5	152	50	75	1	3258954182342
E418235	8	9.5	152	50	85	1	3258954182359

PUNÇÃO-DE-BICO

→ Dureza 34-44 para a zona de pancada e 50-58 para a ponta.

→ Mono-corpo para maior robustez e durabilidade.

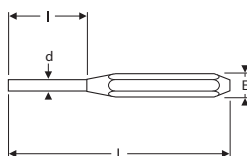

	d mm"	E mm	L mm	l mm	Peso g		EAN
E150501	2.5	9.5	102	25.4	51	1	3258951505014
E150502	4	9.5	102	25.4	53	1	3258951505021
E418227	6	9.5	102	25.4	55	1	3258954182274
E418228	8	11.1	114	25.4	86	1	3258954182281
E418236	10	11.1	127	25.4	100	1	3258954182366



PUNÇÕES AUTOMÁTICOS

- Dureza 56-61 para a ponta.
- Carga de activação E150503: 6 a 12,5 kg - E150504: 12,2 a 18,5 kg.
- Corpo em bronze.

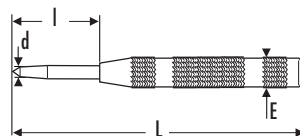
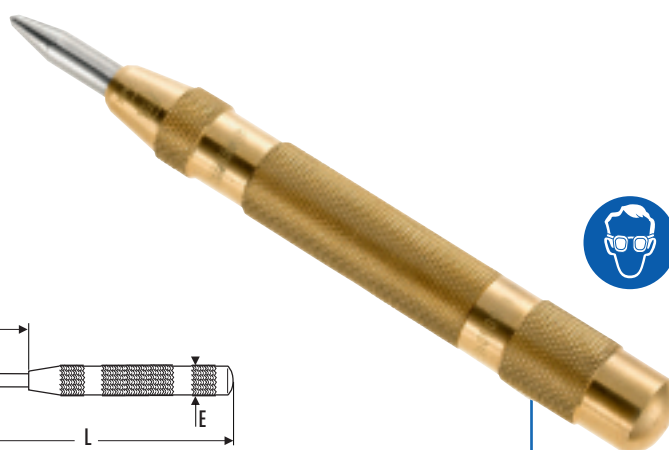

	d mm"	E mm	L mm	l mm	Peso g	📦	EAN
E150503	4	14	130	27	72	1	3258951505038
E150504	7	17	151	26.7	133	1	3258951505045

ESCOPRO EXTRA PLANO 26 MM

- DIN 7255
- Tratado para 54-58 HRC.

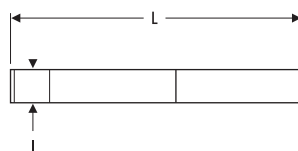
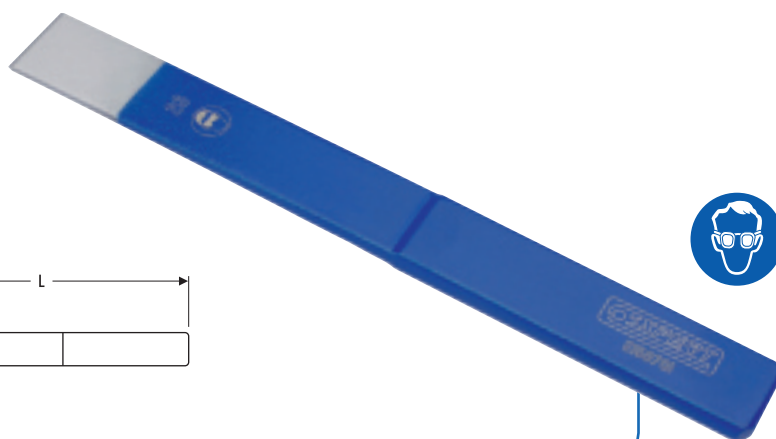

	L mm	l mm	Peso g	📦	EAN
E150701	235	26	250	1	3258951507018

ESCOPRO

- DIN 7255
- Tratado para 54-58 HRC.

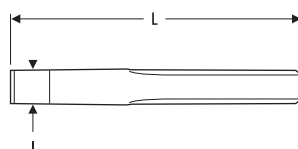

	L mm	l mm	Peso g	📦	EAN
E150702	150	21	195	1	3258951507025
E150703	200	24	350	1	3258951507032
E150704	250	27	510	1	3258951507049



CORTE

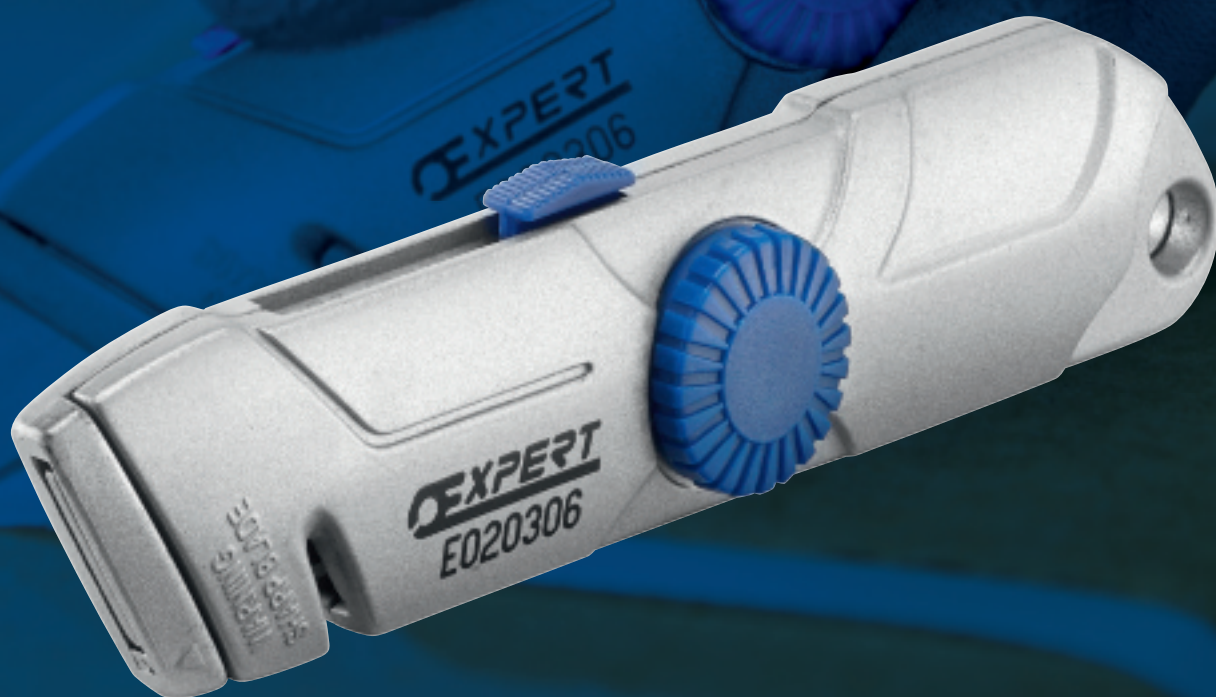



Serras para metais

P.186



Limas

P.187



Corta-rebites

P.189



Tesouras

P.190



X-actos

P.192



X-ato de segurança

P.193



Tesouras

P.193



Corta-tudo

P.193



**SERRAS PARA METAIS****SERROTE DE ARCO - 1 LÂMINA**

- Serra com pega revólver - Tensão até 100Kg - Capacidade de corte de 100 mm.
- Pré-tensão da lâmina graças a um sistema de alavanca; Regulação e colocação sob tensão facilitadas.
- Fornecido com uma lâmina bi-metálica.
- Arco em aço cromado - Parte dianteira e traseira com revestimento pintura.
- Lâmina 300 mm.

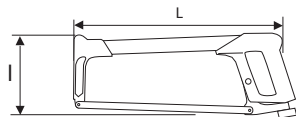

	L mm	l mm	Peso g		EAN
E115122	376	131	590	1	3258951151228

**SERROTE DE ARCO - CABO DE MADEIRA + 1 LÂMINA**

- Arco em metal revestimento epóxico - Tensão da lâmina até 80KG - capacidade de corte de 100 mm.
- Tensão da lâmina na parte dianteira do arco.
- Fornecido com uma lâmina HSS.
- Pega em madeira.
- Lâmina 300 mm.

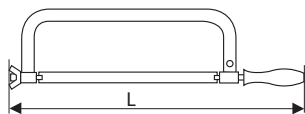

	L mm	Peso g		EAN
E115123	455	550	1	3258951151235

**LÂMINA BI-METÁLICA - 300 MM**

- Lâmina sobresselente para serras para metais E115122 e E115123.
- Acondicionadas por 10 em tubo plástico.
- Encomenda por múltiplos de 10. Exemplo: 20 x E115126 = 20 lâminas.

	L mm	Peso g		EAN
E115126	300	160	10	3258951151266

**MINI-SERRA - 1 LÂMINA**

- Moldura do arco em alumínio esmaltado.
- Leve e bom agarre na mão - Ideal para os pequenos trabalhos em matérias plásticas e metal.
- Entregue com uma lâmina em aço carbono.
- Pega em plástico.
- Lâmina 155 mm.

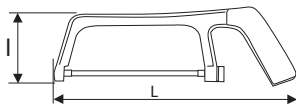

	L mm	l mm	Peso g		EAN
E020101	257	94	140	1	3258950201016





LÂMINA - 150 MM

- Lâmina sobresselente para mini-serra E020101.
- Acondicionadas por 10 em tubo plástico.
- Encomenda por múltiplos de 10. Exemplo: 20 x E020103 = 20 lâminas.



E020103	L mm	Peso g	📦	EAN
E020103	150	120	10	3258950201030

LIMAS

JOGO DE 5 LIMAS MEIO-MURÇO

- 1 lima plana meio-murço 200 mm: E020602.
- 1 lima meia-cana meio-murço de 200 mm: E020604.
- 1 lima redonda meio-murço 200 mm: E020607.
- 1 lima quadrada meio-murço 200 mm: E020609.
- 1 lima triangular meio-murço 200 mm: E020610.



E020613	Qty	Peso g	📦	EAN
E020613	5	826	1	3258950206134

JOGO DE 3 LIMAS MEIO-MURÇO

- 1 lima plana meio-murço 200 mm: E020602.
- 1 lima meia-cana meio-murço de 200 mm: E020604.
- 1 lima redonda meio-murço 200 mm: E020607.



E020612	Qty	Peso g	📦	EAN
E020612	3	450	1	3258950206127

MÓDULO DE 4 LIMAS

- 1 lima plana bastarda 200 mm: E020603.
- 1 lima meia-cana meio-murço de 200 mm: E020604.
- 1 lima redonda meio-murço 200 mm: E020607.
- 1 lima quadrada meio-murço 200 mm: E020609.
- Tabuleiro vazio: E010514.



E020611	Qty	Peso g	📦	EAN
E020611	4	758	1	3258950206110





LIMAS

LIMAS PLANAS

→ Pega em plástico.

→ A = meio-murço. B = bastarda.



	Tipo	Peso g		EAN
E020602	A	180	5	3258950206028
E020603	B	180	5	3258950206035

LIMAS MEIA-CANA

→ Pega em plástico.

→ A = meio-murço. B = bastarda.



	Tipo	Peso g		EAN
E020604	A	164	5	3258950206042
E020605	B	164	5	3258950206059

LIMAS REDONDAS

→ Pega em plástico.

→ A = meio-murço. B = bastarda.



	Tipo	Peso g		EAN
E020607	A	106	5	3258950206073
E020608	B	106	5	3258950206080

LIMA QUADRADA MEIO-MURÇO

→ Pega em plástico.

→ Lima meio-murço.



	Tipo	Peso g		EAN
E020609	A	110	5	3258950206097



LIMA TRIANGULAR MEIO-MURÇO

- Pega em plástico.
- Lima meio-murço.



	Tipo	Peso g		EAN
E020610	A	200	5	3258950206103

CORTA-REBITES

CORTA-CAVILHAS BRAÇOS TUBULARES

- Garras forjadas de cromo molibdênio.
- Capacidade de corte de aço até 160kg/mm².
- Braços tubulares.



	L mm	d mm -100kg/mm	d mm -130kg/mm	d mm -160kg/mm	Peso g		EAN
E195561	300	6	4	3	720	1	3258951955611
E117750	350	8	6	5	1220	1	3258951177501
E117751	450	8	6	6	1580	1	3258951177518
E117752	600	10	8	7	2600	1	3258951177525
E117753	750	11	10	8	3950	1	3258951177532
E117754	900	12	11	9	5450	1	3258951177549
E117755	1050	14	12	10	8100	1	3258951177556

LÂMINAS PARA CORTA-REBITES

- Entregue com parafuso.



	Coupe boulon	Peso g		EAN
E195568	E195561	28	1	3258951955680
E117756	E117750	40	1	3258951177563
E117757	E117751	50	1	3258951177570
E117758	E117752	87	1	3258951177587
E117759	E117753	125	1	3258951177594
E117760	E117754	175	1	3258951177600
E195569	E117755	265	1	3258951955697



**TESOURAS****TESOURA AVIAÇÃO CORTE À DIREITA - LONGO ALCANCE**

→ ASME B 107.16M

- Lâminas forjadas - Forte desmultiplicação e afastamento das pontas por mola encastrada garantem uma utilização de longa duração confortável.
- Corte preciso; lâmina ligeiramente estriada para evitar qualquer risco de deslizamento.
- Desempenhos de corte: Inox 80 kg/mm² 0,8 mm - Aço semi-duro 1,2 mm.
- Confortável: revestimento dupla matéria - Código de cores normalizado.

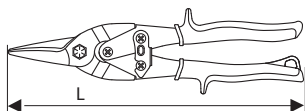

	L mm	l mm	Comprimento lâmina mm	Peso g	☒	EAN
E214563	250	52	45	399	10	3258952145639
E020906	290	65	82	400	10	3258950209067

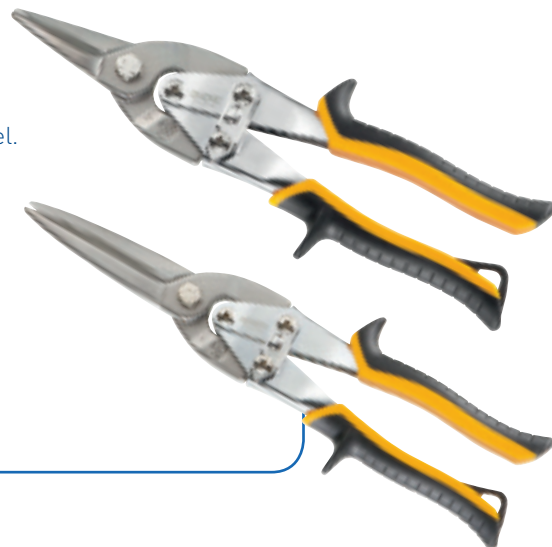
**TESOURAS AVIAÇÃO**

→ ASME B 107.16M

- Lâminas forjadas - Forte desmultiplicação e afastamento dos bicos por mola encastrada garantem uma utilização de longa duração confortável.
- Corte preciso, lâmina ligeiramente estriada para evitar qualquer risco de deslizamento.
- Desempenhos de corte: Inox 80 Kg/mm² 0,8 mm - Aço semi-duro 1,2 mm.
- Confortável: revestimento de dupla matéria.
- Código de cor normalizado seguindo o sentido do corte:
- E020902: Corte à direita - verde.
- E020903: Corte à esquerda - vermelho.

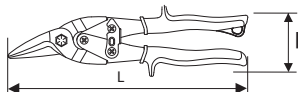

	L mm	l mm	Comprimento lâmina mm	Peso g	☒	EAN
E020902	248	52	40	400	10	3258950209029
E020903	248	52	40	400	10	3258950209036

**TESOURAS DESMULTIPLICADAS PARA RECORTE**

→ ASME B 107.16M

- Tesoura tipo passa-rebordo - Forte desmultiplicação e afastamento das lâminas por mola encastrada garantem uma utilização de longa duração confortável.
- Código de cor normalizado seguindo o sentido do corte:
- E020904: Corte à direita - verde.
- E020905: Corte à esquerda - vermelho.

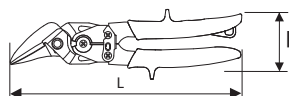

	L mm	l mm	Comprimento lâmina mm	Peso g	☒	EAN
E020904	248	65	45	380	10	3258950209043
E020905	248	65	45	380	10	3258950209050





TESOURA DE RECORTE

- Lâminas forjadas em aço carbono.
- Tesoura concebida para cortar chapa de forma precisa.
- Desempenhos de corte: Inox 80Kg/mm² 0,8 mm - Aço semi-duro 1 mm.
- Pegas revestidas a PVC.

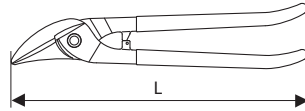
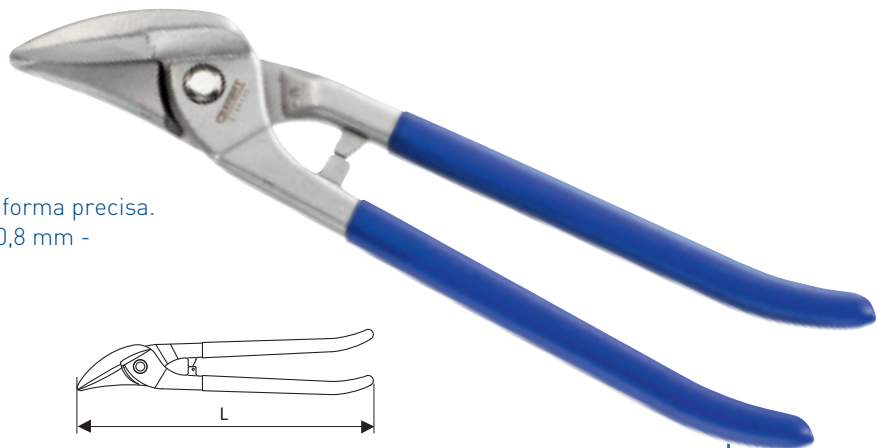

	L mm	l mm	Comprimento lâmina mm	Peso g	☒	EAN
E184195	270	55	42	380	10	3258951841952

TESOURA PARA CHAPA UNIVERSAL

- 2 lâminas estreitas, corte à direita, em linha recta e curva.
- Lâminas forjadas em liga de aço fina.
- Dureza das lâminas 56 - 60 HRC.
- Desempenho de corte: 120 kg/mm² 1,2 mm.
- Lâminas polidas.
- Pegas lacadas de alta qualidade.

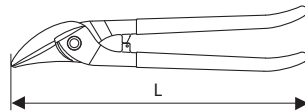
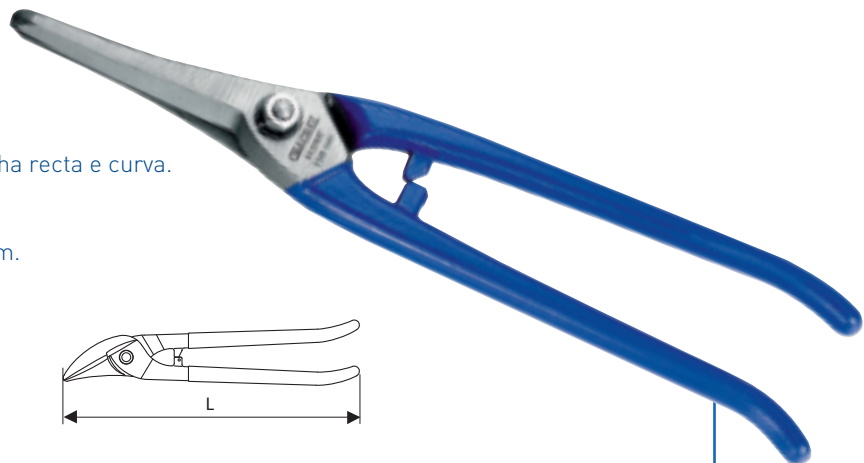

	L mm	Peso g	☒	EAN
E020907	250	470	10	3258950209074

TESOURA PARA CHAPA SEMI-UNIVERSAL

- 1 lâmina estreita, 1 lâmina larga, corte à direita, em linha recta e curva.
- Lâminas forjadas em liga de aço fina.
- Dureza das lâminas 56 - 60 HRC.
- Desempenho de corte: 120 kg/mm² 1,2 mm.
- Lâminas polidas.
- Pegas lacadas de alta qualidade.

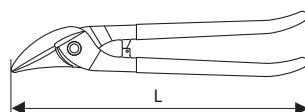

	L mm	Peso g	☒	EAN
E020908	260	476	10	3258950209081





X-ACTOS

X-ACTO 9 MM

- Lâmina divisível.
- Parte-lâmina amovível na tampa.
- Clip de bolso integrado.
- Armazenamento para 1 lâmina de substituição.
- Fornecido com 2 lâminas.



E020301	L mm	Peso g		EAN
E020301	140	28	10	3258950203010

LÂMINAS DE X-ACTOS 9 MM

- 10 segmentos de lâmina destacável.

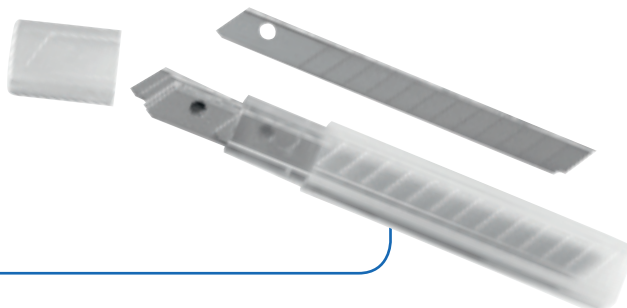

E020303	Peso g		EAN
E020303	35	10	3258950203034

X-ACTO 18 MM

- Lâmina divisível.
- Parte-lâmina amovível na tampa.
- Armazenamento para 1 lâmina de substituição.
- Fornecido com 2 lâminas.



E020302	L mm	Peso g		EAN
E020302	160	74	10	3258950203027

LÂMINAS DE X-ACTOS 18 MM

- 10 segmentos de lâmina destacável.

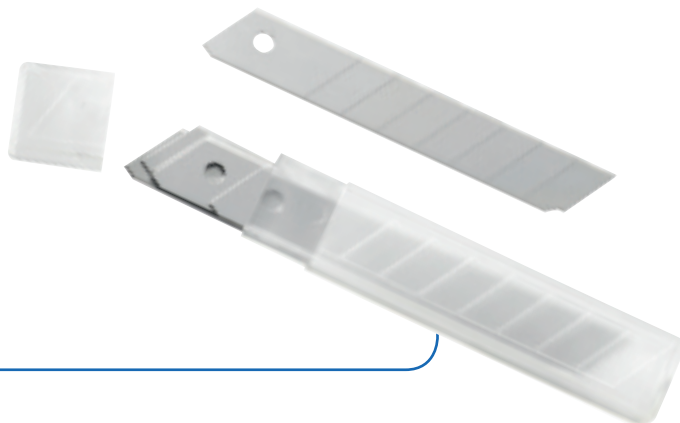

E020304	Peso g		EAN
E020304	92	10	3258950203041



X-ATO DE SEGURANÇA

X-ATO DE SEGURANÇA

- Retorno automático da lâmina no final da aplicação.
- Fornecido com uma lâmina.
- Fenda corta-fio.
- Dureza das lâminas: 58 - 62 HRc.



	Peso g		EAN
E020306	130	12	3258950203065

JOGO DE 12 LÂMINAS



	Peso g		EAN
E020307	48	25	3258950203072

TESOURAS

TESOURAS

- Lâmina direita grande.
- Acabamento: Níquel.
- Revestimentos em nylon.



	L mm	Peso g		EAN
E051601	145	100	5	3258950516011

TESOURAS

Ver secção electricidade eletrónica p 212.



CORTA-TUDO

TESOURA CORTA-TUDO

- Alto desempenho: corta qualquer tipo de material: cartão, borracha, pvc, couro 5 mm, chapa fina, cabo eléctrico.
- Indispensável, irá garantir um corte preciso e limpo, graças às lâminas ligeiramente dentadas.
- Seguro: bloqueio na posição fechada.
- Confortável: Revestimento dupla matéria.
- Comprimento de lâmina 58 mm.

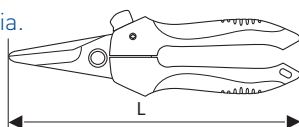

	L mm	Peso g		EAN
E020901	190	201	1	3258950209012



ILUMINAÇÃO





Projetores

P.196



Lanterna de inspeção

P.198



Sistema de iluminação

P.200

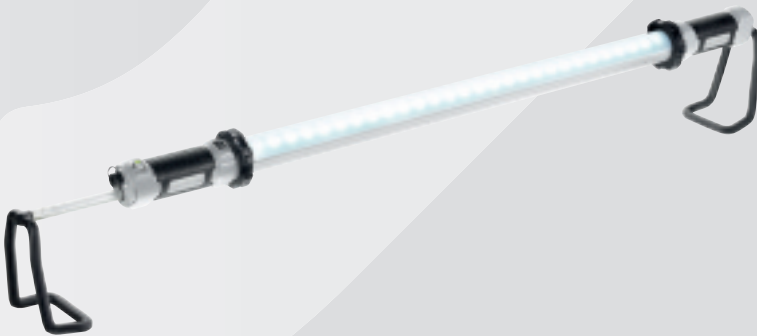

Lâmpadas flexíveis

P.201





PROJETORES

PROJETOR DE CABO 35W

- 1 Led COB 35W.
- Potência de iluminação: 1200 lúmens ou 3500 lux a 1,0 m.
- IP 65.
- Gancho de suspensão.
- Pode ser utilizado com os dois suportes:
E201424: Suporte no solo.
E201425: Tripé.
- Dimensões: 250 x 185 x 87 mm.



E201412	Peso g		EAN
E201412	1980	1	3258952014126

PROJETOR RECARREGÁVEL 15W EM SUPORTE

- 1 Led COB 15W.
- Dois níveis de potência de iluminação:
8W: 600 lúmens ou 350 lux a 1,0 m.
15W: 1200 lúmens ou 600 lux a 1,0 m.
- Autonomia:
8W: até 7 horas.
15W: até 3,5 horas.
- Tempo de carga: 3-4 horas.
- Entregue com carregador.
- IP 65.
- Suporte no solo fornecido (E201424).
- Suporte alternativo: Tripé (E201425).
- Dimensões: 187 x 138 x 80 mm.



E201411	Peso g		EAN
E201411	2154	1	3258952014119



ACESSÓRIOS

- Tripé para projetor de cabo 35W E201412 e para projetor recarregável 15W E201411.
- Regulável em altura.

E201425	Peso g		EAN
E201425	2450	1	3258952014256



SUPORE DE CHÃO

- Suporte de chão para projetor com fios 35W E201412 e E201411 projetor sem fios de 15W.
- Punho para transporte.

E201424	Peso g		EAN
E201424	780	1	3258952014249



LANTERNA DE INSPECÇÃO

LANTERNA

- Lanterna recarregável.
- 1 LED COB de alto desempenho.
- 2 potências de iluminação:
250 lúmens/70 lux a 1 m.
500 lúmens/140 lux a 1 m.
- Autonomia: 2,5/5 h.
- Indicador de bateria.
- IP54.
- Equipado com 2 ímãs na parte traseiro.
- Gancho de suspensão.
- Entregue com cabo adaptador de alimentação.
- Baterias de íões de lítio.

E201431	Peso g		EAN
E201431	260	1	3258952014317





LANTERNA DE INSPEÇÃO

LANTERNA DE INSPEÇÃO FLEXÍVEL

- Lanterna de inspeção recarregável.
- 6 LEDs SMD de alto desempenho + 1 LED na extremidade.
- Potência de iluminação principal: 200 lúmens/300 lux a 50 cm.
- Potência de iluminação na extremidade: 50 lúmens/450 lux a 50 cm.
- Autonomia: 5 h de iluminação principal - 9 h de iluminação na extremidade.
- Tempo de carregamento: 4,5 h.
- Base magnética flexível em 180°.
- Equipada com 2 ímãs na parte traseira e 2 ganchos escamoteáveis.
- Entregue com adaptador de alimentação e cabo de isqueiro 12V.
- Baterias de íões de lítio.
- Dimensões: 50 x 40 x 250 mm.

E201427	Peso g		EAN
E201427	260	1	3258952014270



LANTERNA-CANETA

- 6 LEDs COB de alto desempenho + 1 lanterna LED SMD.
- Potência de iluminação principal: 110 lúmens: 50 lux a 1 m.
- Potência de iluminação na lanterna: 70 lúmens/35 lux a 1 m.
- IP54.
- 3 x pilhas AAA.

E201432	Peso g		EAN
E201432	135	1	3258952014324





LANTERNA-CANETA RECARREGÁVEL POR USB

- Lanterna-caneta recarregável por USB.
- 6 LEDs SMD de alto desempenho + 1 LED na extremidade.
- Potência de iluminação principal: 45 lúmens ou 125 lux a 50 cm.
- Potência de iluminação na extremidade: 3 lúmens ou 25 lux a 50 cm.
- Autonomia: 3 h de iluminação - 12 h de iluminação na extremidade.
- Dimensões: 18 x 33 x 170 mm.

E201406	Peso g	📦	EAN
E201406	60	12	3258952014065



ESPELHO TELESCÓPICO DE LEDS

- Iluminação dois LEDs.
- Tamanho extensível: de 290 a 876 mm.
- Cabeça rotativa e ângulo adaptável.
- 1 pilha botão 3V de lítio fornecida.

E051401	Peso g	📦	EAN
E051401	115	1	3258950514017



GARRA FLEXÍVEL MAGNÉTICA DE LED

- Braço flexível de 252 mm.
- 4 garras.
- Iluminação LED.
- Forte ponta magnética.
- 3 pilhas LR44 fornecidas.

E201414	Peso g	📦	EAN
E201414	180	1	3258952014140





LANTERNA DE INSPECÇÃO

LÂMPADA MAGNETIC

- Mini LED Magnetic lâmpada 2 .
- Luzes automaticamente em contato com objetos de metal.
- Ímã V para caber todos os tipos de ferramentas.
- Bateria incluída .



E201426	Peso g		EAN
E201426	60	1	3258952014263

SISTEMA DE ILUMINAÇÃO

SISTEMA DE ILUMINAÇÃO DE LED'S - 2 NÍVEIS DE ILUMINAÇÃO

- Sistema de iluminação recarregável.
- 28 LEDs SMD de alta potência.
- 2 níveis de potência baixa/alta.
- Potência de iluminação:
7W: 550 lúmens/240 lux a 1 m.
15W: 1150 lúmens/440 lux a 1 m.
- Tempo operacional: 7W: 4 h.15W: 2,5 h.
- Tempo de carga: 3,5 h.
- Feixe orientável.
- 2 ganchos extensíveis de 1,14 m a 1,90 m.
- Entregue com adaptador de alimentação.
- Baterias de íões de lítio.
- Dimensões: 1138 x 179 x 96 mm.

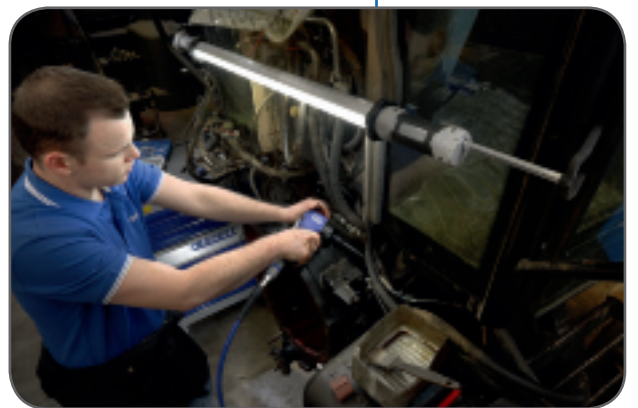

E201429	Peso g		EAN
E201429	1500	1	3258952014294



LÂMPADAS FLEXÍVEIS

LANTERNA FLEXÍVEL

- 1 LED SMD de alta potência.
- Potência de iluminação: 250 lúmens ou 1551 lux a 50 cm.
- Autonomia: 15 h.
- Feixe de iluminação de óptica regulável.
- Base magnética.
- Funciona com 2 pilhas AAA (não fornecidas).
- IP 54.
- Dimensões: 40 x 414 mm.

E201409	Peso g	📦	EAN
	350	1	3258952014096



LANTERNA FLEXÍVEL ULTRAVIOLETA

- 7 LEDs UV.
- Autonomia: 25 h.
- Base magnética.
- Funciona com 2 pilhas AAA (não fornecidas).
- IP 54.
- Dimensões: 40 x 414 mm.

E201410	Peso g	📦	EAN
	335	1	3258952014102



MINI LANTERNA FLEXÍVEL DE LEDS COM BASE MAGNÉTICA

- Ideal para iluminar os espaços reduzidos pouco acessíveis.
- 3 LEDs brancos com 5 mm de diâmetro.
- 21 lúmens.
- 150 lux a 0,5 m.
- Base magnética.
- Corpo flexível: 440 mm.
- Funciona com 3 pilhas LR44 (fornecidas).
- Dimensões: 367 x 7,5 mm.

E201413	Peso g	📦	EAN
	90	1	3258952014133



MANUTENÇÃO

TUBOS - EXTRACTORES





Manutenção

P.204



Ferramentas de tubos

P.208



Extracção

P.211





MANUTENÇÃO

MALA DE MANUTENÇÃO

- Para manutenção móvel.
- 124 ferramentas.



	Dimensões mm	Peso kg		EAN
E034806	L.565 x P.415 x H.92	8,30	1	3258950348063

RASCADOR

- Pega plástica.
- Porta-lâminas em metal.
- Lâminas substituíveis.
- 1 lâmina fornecida.



	Peso g		EAN
E201519	310	1	3258952015192

LÂMINAS SOBRESSELENTES PARA RASCADOR

- Para rascadores E201519 e E201209.
- Em caixa de 5 lâminas.

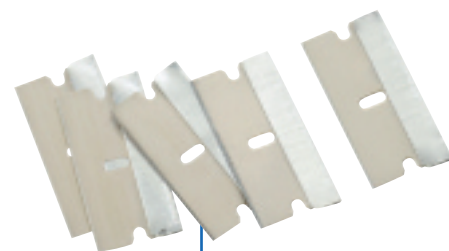

	Peso g		EAN
E201520	12	1	3258952015208



TORNOS

- Forjados, construção em aço robusto para uma longa vida útil.
- Bigorna integrada.
- Maquinado com precisão.

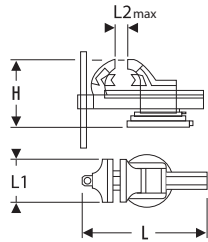

	H mm	L mm	L1 mm	L2 mm	Peso kg	☒	EAN
E090401	148	305	104	100	7.5	1	3258950904016
E090402	165	365	129	125	11	1	3258950904023
E090403	187	406	154	150	14	1	3258950904030
E090404	205	500	205	200	18.5	1	3258950904047

ALAVANCAS DE ESFORÇO

- Forjadas a partir de aço em liga de cromo.
- A forma da cabeça funciona como um ponto de apoio para aumentar o esforço.



	L mm	Peso g	☒	EAN
E150901	300	234	1	3258951509012
E150902	413	480	1	3258951509029

CHAVES PARA ANDAIMES

- Concebidas para o trabalho em andaimes.
- Mecanismo 32 dentes.
- Mudança de sentido por inversor.
- Mecanismo de dupla face proporciona dois tamanhos por chave.
E110961 : 17 x 19 mm.
E110962 : 21 x 22 mm.
- Acabamento: Zinco.

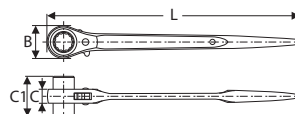
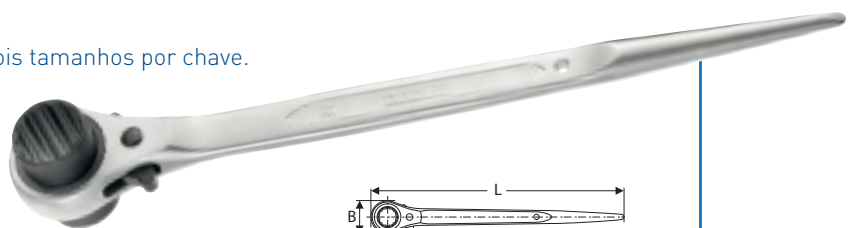

	B mm	C mm	C1 mm	L mm	Peso g	☒	EAN
E110961	40.7	17	50	309	430	1	3258951109618
E110962	40.7	17	50	309	714	1	3258951109625





MANUTENÇÃO

CORTADOR DE VIDRO

- Corpo acetato.
- Cabeça em aço niquelado.
- Fornecido com 5 roletes no disco.



	L mm	Peso g		EAN
E020305	135	34	1	3258950203058

ALICATE PARA REBITAR 270 MM

- Ponta a 90°.
- 4 bicos substituíveis de 2-3-4-5 mm diâmetro.
- Ejeção automática da haste do rebite.
- Chave para substituição de matriz incorporada.
- Construção durável em aço.



	L mm	Peso g		EAN
E169804	200	572	1	3258951698044

ALICATE SACA-BOCADOS

- Para diâmetros de: 3-3,2-3,5-4-4,5-5.
- Para pele, chapa, borracha...
- Acabamento: cromado.



	L mm	Peso g		EAN
E090303	220	280	1	3258950903033

ESPUMA PARA APOIO DE JOELHOS

- Possibilidade de introduzir duas lâmpadas para iluminar a zona de trabalho pretendida.
- Superfície tratada para resistir aos líquidos e a uma utilização repetida.
- Pega de transporte.
- Tamanho adaptado para guardar numa caixa de ferramentas em tecido ou na mochila com rodas.
- Dimensões: C.428 x P.250 x A.32 mm.

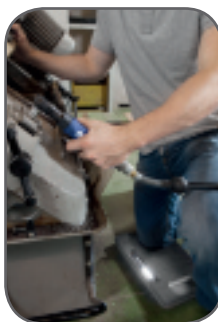

	Peso g		EAN
E200131	160	1	3258952001317



ALMOLOTOLIAS

- Bomba de vácuo.
- Tubo rígido com bocal em cobre.



	Recipiente	Peso g	☒	EAN
E090701	300 ml	215	1	3258950907017
E090702	500 ml	310	1	3258950907024

PISTOLA PARA MASSA

- Pressão: 400 bars.
- Tubo rígido.
- Flexível [C. 230 mm D. 14 mm].
- Utilização com massa em recarga ou massa avulsa.
- Capacidade: 500 cm³ ou 400 g.



	Peso g	☒	EAN
E090705	1145	1	3258950907055

PISTOLA DE SILICONE

- Ideal para os cartuchos e embalagens de cola para pára-brisas.
- Tubo em alumínio.
- Pega ergonómica.



	Peso g	☒	EAN
E090703	875	1	3258950907031





FERRAMENTAS DE TUBOS

CHAVES PARA TUBOS TIPO SUECA 45°

- Corpo em aço com cromo-vanádio.
- Maxila inclinada a 45 graus.
- Envernizadas.

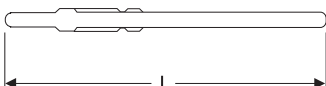
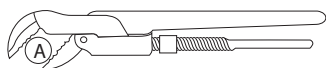

	A máx. "	A máx. mm	L mm	Peso g	☒	EAN
E090106	1/2"	40	270	480	1	3258950901060
E090107	1"	60	340	800	1	3258950901077
E090108	1 1/2	65	430	1400	1	3258950901084
E090109	2"	85	550	2350	1	3258950901091



CHAVES PARA TUBOS TIPO SUECA 90°

- Corpo em aço com cromo-vanádio.
- Maxila inclinada a 90° graus.
- Envernizadas.

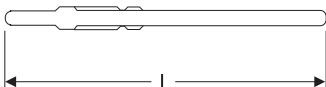
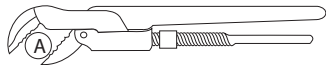

	A máx. "	A máx. mm	L mm	Peso g	☒	EAN
E090110	1"	65	330	800	1	3258950901107
E090111	1 1/2	85	420	1350	1	3258950901114
E090112	2"	100	540	2500	1	3258950901121
E090113	3"	150	630	4200	1	3258950901138



CHAVES PARA TUBOS EM ALUMÍNIO

- Corpo em alumínio.
- Maxila fixa em aço forjado.
- Envernizadas.

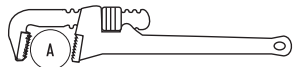
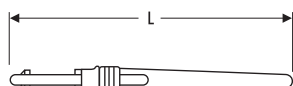

	A máx. "	A máx. mm	L mm	Peso g	☒	EAN
E090114	2 1/2	76	450	1340	1	3258950901145
E090115	3"	90	600	2230	1	3258950901152
E090116	5"	142	900	4000	1	3258950901169





CHAVES PARA TUBOS

- Corpo em ferro fundido.
- Garra fixa em aço forjado.
- Tratamento alta frequência das garras para uma grande resistência e uma perfeita fixação dos tubos.

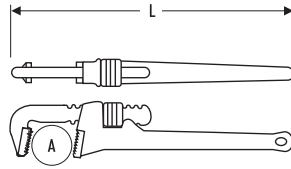

	A máx. "	A máx. mm	L mm	L "	Peso kg	☒	EAN
E117820	1"	26	200	8	0,40	1	3258951178201
E117821	1"1/4	33	250	10	0,78	1	3258951178218
E117822	1"3/4	48	350	14	1,50	1	3258951178225
E117823	2"1/4	60	450	18	2,40	1	3258951178232
E117824	2"3/4	75	600	24	4	1	3258951178249
E117825	4"	102	900	36	9	1	3258951178256

ALICATE PARA TUBOS

- ISO 8976.
- 7 posições de regulação.
- Acabamento: aço inoxidável pintado.



	L mm	Profundidade (mandíbulas) mm	Peso g	☒	EAN
E090105	250	33	350	1	3258950901053

ALICATE PARA TUBOS

- Alicate para o aperto de tubos de diferentes diâmetros(4 à 30 mm).
- Acabamento: chapa polida, cabos lacados.



	L mm	Peso g	☒	EAN
E090104	230	380	1	3258950901046





FERRAMENTAS DE TUBOS

CHAVE UNIVERSAL COM CINTA

- Cinta em borracha.
- Para diâmetro de 30 a 160 mm.

	Peso g		EAN
E200240	341	1	3258952002406



CHAVE COM CORRENTE

- Corrente em aço.
- Para diâmetro de 30 a 160 mm.

	Peso g		EAN
E200241	421	1	3258952002413



CHAVES DE CINTA PARA FILTROS

- Corpo alumínio.
- Cinta em nylon.

	A máx. "	A máx. mm	L mm	Peso g		EAN
E117827	125	4	315	290	1	3258951178270
E117828	165	6	315	310	1	3258951178287



CINTAS DE SUBSTITUIÇÃO

	Chaves de cinta para filtros		EAN
E090101	E117827	1	3258950901015
E090102	E117828	1	3258950901022

CORTA-TUBOS DE COBRE

- Capacidade de corte tubo Ø 16 mm máx. [E117829].
- Capacidade de corte tubo Ø 32 mm máx. [E117830].
- Regulação fácil e rápida por rolete.
- Corta rebarba integrado.
- Fornecido com lâmina de substituição.



	L mm	Peso g		EAN
E117829	55	120	1	3258951178294
E117830	140	300	1	3258951178300



EXTRACÇÃO

EXTRACTOR 2 GARRAS

- Transformação possível em sacar pelo interior ou exterior com a mesma garra.
- Fabricado em aço de crómio vanádio.
- Acabamento: cromado.

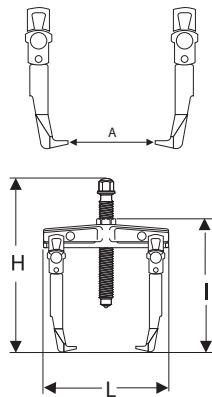

	L x t x H mm	A mm	B mm	T kN	Griffes	Vis	Peso kg	☒	EAN
E096002	115 x 105 x 133	65	14	15	E096007	E096010	0.4	1	3258950960029
E096003	146 x 155 x 182	90	17	30	E096008	E096011	0.9	1	3258950960036
E096004	186 x 155 x 182	130	17	30	E096009	E096011	1	1	3258950960043
E096005	247 x 233 x 283	175	22	40	E096009	E096012	2.8	1	3258950960050
E096006	297 x 233 x 283	220	22	40	E096009	E096012	3	1	3258950960067

GARRAS

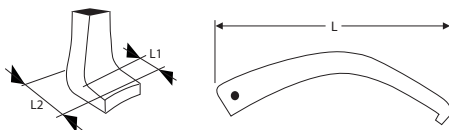

	L mm	L1 mm	L2 mm	Peso g	☒	EAN
E096007	100	10	16	82	1	3258950960074
E096008	155	15	24	187	1	3258950960081
E096009	225	22	33	554	1	3258950960098

PARAFUSO

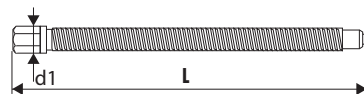

	L mm	d1 mm	Peso g	☒	EAN
E096010	135	14	150	1	3258950960104
E096011	183	17	199	1	3258950960111
E096012	283	22	434	1	3258950960128



ELECTRICIDAD - ELECTRÓNICA





Cravação

P.214



Decapador

P.215

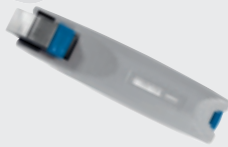

Alicates isolados 1000 V

P.216



Chave Busca Pólos

P.220



Tesouras de electricista

P.220



Chave de eletrônica

P.222



Alicates electrotécnicos

P.224



Corta-cabos

P.214



Alicates para descarnar

P.215



Alicate isolados 1000 V

P.218

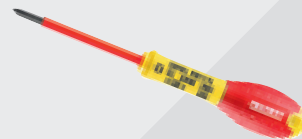

Navalhas de Eléctricista

P.220



Soldadura

P.220



Alicates de pinças

P.223





CRAVAÇÃO

ALICATE PARA CRAVAR

- Matriz 3 perfis de 0,4 a 6mm².
- Para terminais com isolantes PVC, PC e poliamida.
- Dupla cravação para cravar numa única operação garante boa união de contacto e o isolante.
- Cabo de bi-matéria para um melhor conforto.



	L mm	Peso g		EAN
E050301	235	568	1	3258950503011

ALICATE PARA CRAVAR TERMINAIS NÃO ISOLADOS

- Matriz três formas de 0,5 a 6 mm².
- Para terminais não isolados.
- Cabo de dupla matéria.



	L mm	Peso g		EAN
E050302	235	480	1	3258950503028

ALICATE PARA CRAVAR

- Prensagem de terminais pré-isolados de 1,5 - 2,5 - 6 mm² máx. e terminais tubulares de 1,5 a 6 mm² máx.
- Descarnagem de 0,75 a 6 mm² máx.



	L mm	Peso g		EAN
E117903	220	260	1	3258951179031

CORTA-CABOS

CORTA-CABOS DE COBRE

- ISO 5749
- Capacidade de corte: fios de cobre de 12 mm de diâmetro máximo.
- Revestimento de bi-matéria.



	Peso g		EAN
E189874	270	1	3253561898747



DECAPADOR

DECAPADOR

- Lâmina giratória para um corte circular e longitudinal.
- Pega plástica.
- Entregue com uma lâmina sobressalente na pega.
- Capacidade máxima: \varnothing 28 mm.

E050103	L mm	Peso g		EAN
E050103	140	65	1	3258950501031

LÂMINA SOBRESSELENTE

- Para decapador E050103.

E050104		EAN
E050104	1	3258950501048

ALICATES PARA DESCARNAR

ALICATE AUTOMÁTICO PARA DESCARNAR

- Cravagem para terminais pré-isolados: 0,5 a 6 mm²
- Cravagem para terminais nus: 0,5 a 2,5 mm² e 4 a 6 mm²
- Ajusta-se automaticamente para os cabos de 0,2 a 6 mm.
- Função corta-fio.



E050105	L mm	Peso g		EAN
E050105	216	270	1	3258950501055

ALICATE DE DESCARNAR 170 MM

- Perfeito para descarnar cabos com um ou vários fios de 0,75 a 6 mm².
- Pega ergonómica para um conforto superior.
- Fabricado em França

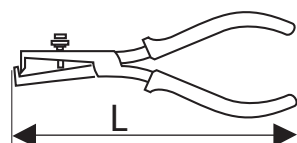

E050106	L mm	Peso g		EAN
E050106	170	185	1	3258950501062





ALICATES ISOLADOS 1000 V

ALICATE DE CORTE PARA ENGENHARIA - ISOLADO 1000 V - VDE

- IEC EN 60900 - DIN ISO 5745
- Cabeça compacta para uma acessibilidade perfeita em espaços reduzidos (quadros elétricos).
- Extremidades de corte concebidas para garantir o melhor desempenho em cabos macios (cobre) e semirrígidos.
- Pega ergonómica para uma utilização confortável durante operações de corte repetitivas.
- E050406 Corda de piano máx. 1,6 mm 220 kg/mm²
- E050407 Corda de piano máx. 1,8 mm 215 kg/mm²
- Fabricado em França



	L mm	Peso g		EAN
E050406	160	200	1	3258950501062
E050407	180	260	1	3258950504070

ALICATE DE PONTAS SEMI-REDONDAS - ISOLADO 1000 V - VDE

- IEC EN 60900 - DIN ISO 5745
- Pontas finas para assegurar um ótimo acesso quando utilizado em espaços reduzidos (quadros elétricos).
- Pontas dentadas finas com corte lateral de cabos - máx. 1,6 mm 160 kg/mm².
- Pega Expert ergonómica para uma utilização confortável durante operações de corte prolongadas e repetitivas.
- Fabricado em França

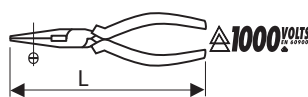

	L mm	Peso g		EAN
E050408	160	177	1	3258950504087
E050409	200	192	1	3258950504094

CONJUNTO DE 2 ALICATES - 1000 V ISOLADO - VDE

- IEC EN 60900
- Contém:
 - Alicate de corte diagonal VDE de 160 mm: E050406
 - Alicate de descarnar VDE de 170 mm: E050416
- Fabricado em França

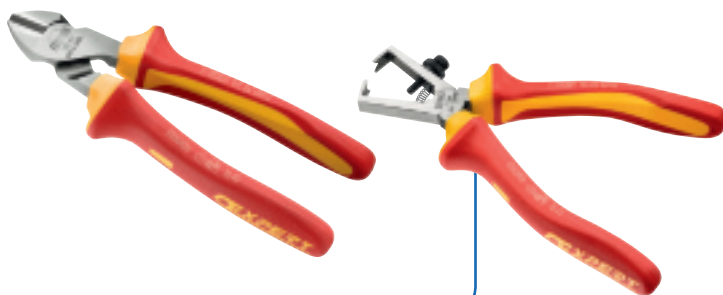

	Qde	Peso g		EAN
E050504	2	565	1	3258950505046

ALICATE MULTIGRIP - 1000 V ISOLADO - VDE

- IEC EN 60900 - DIN ISO 8976
- 6 posições para um ajuste adequado.
- Capacidade máxima das garras 36 mm
- Pega ergonómica em bimatéria.
- Acabamento envernizado.
- Fabricado em França

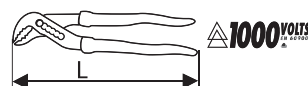

	L mm	Peso g		EAN
E050415	240	365	1	3258950504155



ALICATE DE DESCARNAR 170 MM - 1000 V ISOLADO - VDE

- IEC EN 60900
- Perfeito para descarnar cabos com um ou vários fios de 0,75 a 6 mm².
- Pega ergonómica para um conforto melhorado.
- Fabricado em França

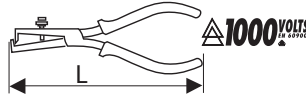

	L mm	Peso g	☒	EAN
E050416	160	185	1	3258950504162

CONJUNTO DE 3 ALICATES - 1000 V ISOLADO - VDE

- IEC EN 60900
- Alicates de corte diagonal VDE de 160 mm: E050406
- Alicates de pontas retas VDE de 160 mm: E050408
- Alicates combinado VDE de 180 mm: E050413
- Fabricado em França

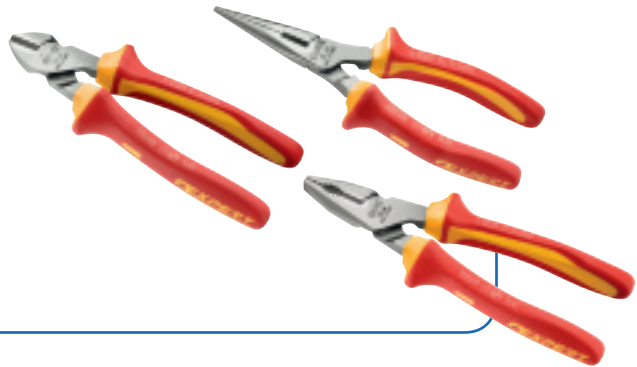

	Qde	Peso g	☒	EAN
E050502	3	730	1	3258950505022

PONTAS SEMIRREDONDAS - ALICATE ANGULAR DE 40° - ISOLADO 1000 V - VDE

- IEC EN 60900 - DIN ISO 5745
- Pontas finas para assegurar um ótimo acesso quando utilizado em espaços reduzidos (quadros elétricos).
- Pontas dentadas finas com cortador lateral de cabos - máx. 1,6 mm 160 kg/mm².
- Pega Expert ergonómica para uma utilização confortável durante operações de corte prolongadas e repetitivas.
- Fabricado em França

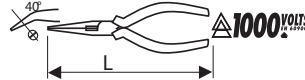

	L mm	Peso g	☒	EAN
E050410	160	177	1	3258950504100
E050411	200	192	1	3258950504117

ALICATE UNIVERSAL - ISOLADO 1000 V - VDE

- IEC EN 60900 - DIN ISO 5745
- Concebido para abranger todas as aplicações de prensão e corte. Extremidades de corte concebidas para cortar todos os tipos de cabos (macios, semirrígidos, rígidos).
- Pega ergonómica para um conforto superior em utilização prolongada e repetitiva.
- E050412 Corda de piano máx. 1,6 mm 220 kg/mm²
- E050413 Corda de piano máx. 1,8 mm 215 kg/mm²
- E050414 Corda de piano máx. 2,0 mm 210 kg/mm²
- Fabricado em França

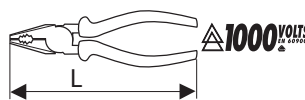

	L mm	Peso g	☒	EAN
E050412	160	195	1	3258950504124
E050413	180	225	1	3258950504131
E050414	200	300	1	3258950504148





ALICATE ISOLADOS 1000 V

JOGO DE 10 CHAVES DE PARAFUSOS ISOLADAS 1000 V PARA PARAFUSOS PHILLIPS®

- EN 60900
- Chave para parafusos de fenda: 2,5 x 50 - 3,5 x 75 - 4 x 100 - 5,5 x 150 mm.
- Chave de parafusos Pozidriv®: PZ1 x 100 - PZ2 x 125.
- Chave de parafusos Phillips®: PH0 x 75 - PH1 x 100 - PH2 x 125.
- Chave de fendas para verificador 100/500 V.



	Qde	Peso g		EAN
E160912	10	670	5	3258951609125



JOGO DE 6 CHAVES DE PARAFUSOS ISOLADAS 1000 V

- EN 60900
- Chave para parafusos de fenda: 2,5 x 50 - 3,5 x 75 - 4 x 100 - 5,5 x 150 mm.
- Chave de parafusos Phillips®: PH1 x 100 - PH2 x 125.



	Qde	Peso g		EAN
E160910	6	430	5	3258951609101



JOGO DE 6 CHAVES DE PARAFUSOS ISOLADAS 1000 V

- EN 60900
- Chave para parafusos de fenda: 2,5 x 50 - 3,5 x 75 - 4 x 100 - 5,5 x 150 mm.
- Chave de parafusos Pozidriv®: PZ1 x 100 - PZ2 x 125.



	Qde	Peso g		EAN
E160911	6	430	5	3258951609118





CHAVES ISOLADAS 1000 V PARA PARAFUSOS DE FENDA

- CEI 60900 - ISO 2380 - 1 - ISO 2380 - 2
- Cabo ergonómico de dupla matéria confortável e eficaz.
- Código de cor forma: vermelho.
- Cada produto é testado em 10 000 V.
- Lâmina redonda, brunida com isolamento em PVC cor-de-laranja.



	A x L2 x B mm	L1 mm	d mm"	Peso g	☒	EAN
E165410	2,5 x 50 x 0,4	149	20	18	5	3258951654101
E165413	2,5 x 50 x 0,4	255	32	84	5	3258951654132
E165411	3,5 x 75 x 0,6	177	27	38	5	3258951654118
E050608	3,5 x 100 x 0,6	202	27	40	1	3258950506081
E165412	4,0 x 100 x 0,8	202	27	43	5	3258951654125
E050609	4,0 x 150 x 0,8	252	27	48	51	3258950506098
E165420	6,5 x 150 x 1,2	266	40	134	5	3258951654200

CHAVES ISOLADAS 1000 V PARA PARAFUSOS PHILLIPS®

- CEI 60900 - ISO 2380-1 - ISO 2380-2
- Cabo ergonómico de dupla matéria confortável e eficaz.
- Código de cor forma: amarelo.
- Cada produto é testado em 10 000 V.
- Lâmina redonda, brunida com isolamento em PVC cor-de-laranja.

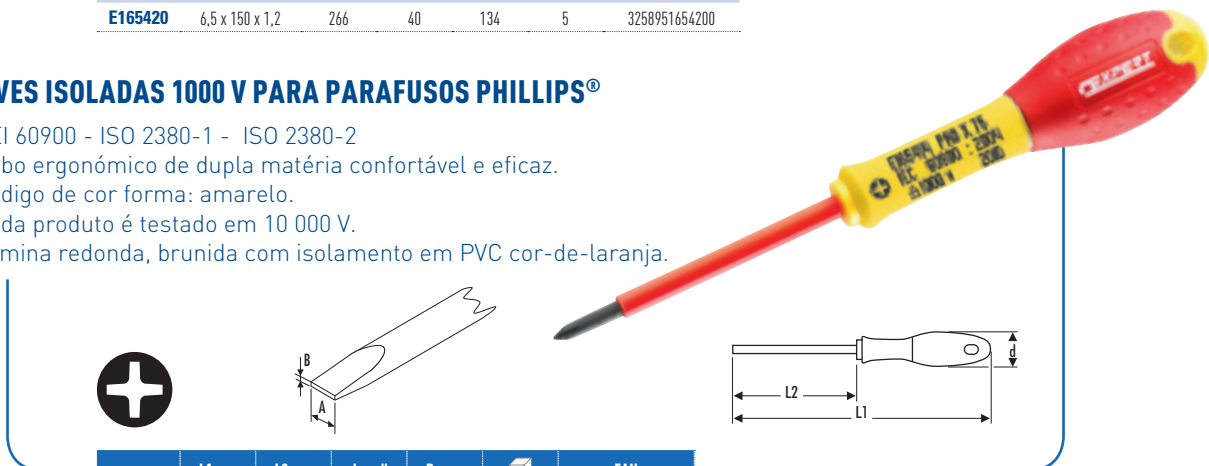

	L1 mm	L2 mm	d mm"	Peso g	☒	EAN
E165414	177	75	27	40	5	3258951654149
E165415	205	100	32	68	5	3258951654156
E165416	230	125	32	89	5	3258951654163
E165421	355	150	40	123	5	3258951654217

CHAVES DE PARAFUSOS ISOLADAS 1000 V PARA PARAFUSOS PHILLIPS®

- CEI 60900 - ISO 2380-1 - ISO 2380-2
- Cabo ergonómico tri-matéria confortável e eficaz.
- Código de cores perfil: azul.
- Todos os produtos são testados a 10 000 V.
- Lâmina redonda, brunida com isolamento em PVC cor-de-laranja.

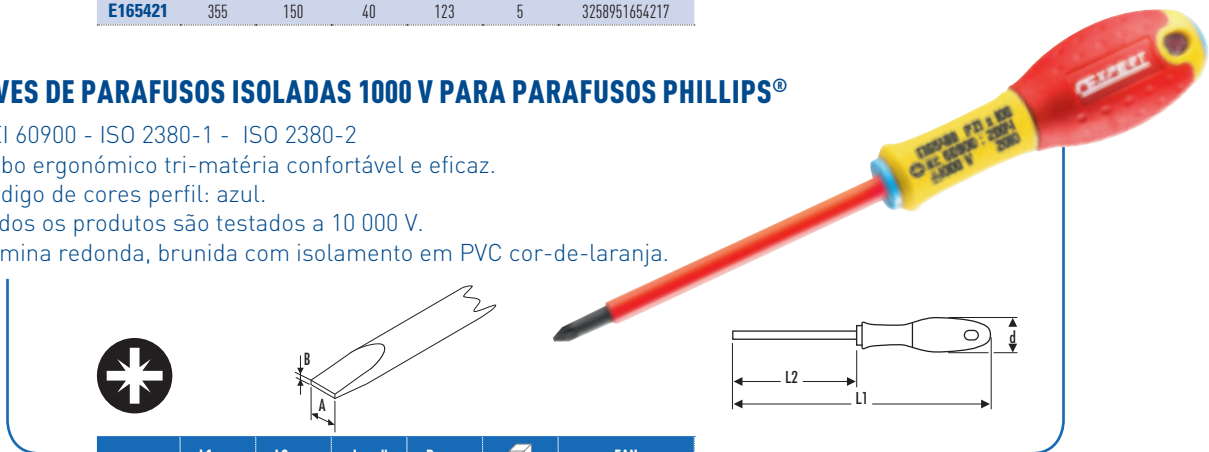

	L1 mm	L2 mm	d mm"	Peso g	☒	EAN
E165418	205	100	32	68	5	3258951654187
E165419	230	125	32	89	5	3258951654194
E165417	177	75	27	40	5	3258951654170
E165422	355	150	40	123	5	3258951654224





CHAVE BUSCA PÓLOS

CHAVE+G58 BUSCA POLOS

- 100/250 V.
- Dimensão da lâmina: 3 x 66 mm.



E161101	Peso g		EAN
	22	60	3258951611012

NAVALHAS DE ELÉTRICISTA

NAVALHA DE ELECTRICISTA COM DESCARNADOR

- Lâmina com 2 entalhes para descarnar e cortar.
- Lâmina Inox.
- Cabo de madeira.

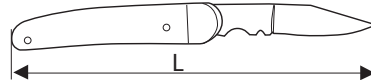

E117762	L mm	Peso g		EAN
	180	77	1	3258951177624

NAVALHA DE ELECTRICISTA 1 LÂMINA

- Lâmina canivete de podar Inox 60 mm.
- Cabo de madeira.

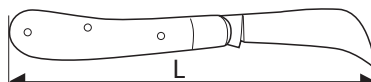

E117763	L mm	Peso g		EAN
	170	85	1	3258951177631

NAVALHA DE ELECTRICISTA 2 LÂMINAS

- Lâmina canivete de podar Inox 60 mm.
- Lâmina direita Inox 80 mm.
- Cabo de madeira.

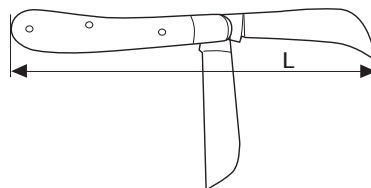

E117767	L mm	Peso g		EAN
	170	115	1	3258951177679



TESOURAS DE ELECTRICISTA

TESOURAS DE ELECTRICISTA

- Lâmina curta reforçada com corta-fio.
- Matéria: aço carbono.
- Acabamento cromado polido.
- Pega revestida a PVC.



E117764	L mm	Peso g		EAN
E117764	150	117	1	3258951177648

TESOURAS DE DUPLA MATÉRIA

- Lâmina longa com um entalhe corta-fio.
- Matéria Inox.
- Pega de dupla matéria.



E184280	L mm	Peso g		EAN
E184280	145	62	1	3258951842805

TESOURAS

Consulte a secção de Corte página 193.



SOLDADURA

FERRO DE SOLDAR

- Entregue com dispositivo de chama e ponta de \varnothing 1,2 mm.
- Recarregável com gaz butano.
- Entregue com instruções de utilização.
- Entregue com ponta de blowlamp.



E090501	L mm	d mm''	Peso g		EAN
E090501	170	19	70	1	3258950905013

PONTAS SOBRESSELENTES

E090502	d mm''	Peso g		EAN
E090502	1,2	6	1	3258950905020





CHAVE DE FENDAS E PHILIPS

JOGO DE 6 CHAVES DE FENDA DE PRECISÃO

- Para parafuso de fenda: 2,0 x 40 - 2,5 x 40 - 3,0 x 40.
- Para parafusos Phillips®: PH 000 - PH 00 - PH 0.



E161102	Qde	Peso g		EAN
E161102	6	155	1	3258951611029

CAIXA COM CHAVES DE FENDA MULTI-LÂMINAS DE PRECISÃO

- Jogo em caixa plástica composta por:
 - 1 porta-lâminas.
 - 6 lâminas de fenda: 1-1,2-1,5-1,8-2-2,5
 - 2 lâminas Phillips®: PH000-PH00.



E161109	Peso g		EAN
E161109	80	1	3258951611098



ALICATES DE PINÇAS

PINÇA LONGA MODELO A DIREITO - 160 MM

- Pontas estriadas direitas.
- Aço inoxidável, ligeiramente polido.
- Revestimento PVC azul.



E501201	L mm	Peso g	☒	EAN
E501201	160	44	1	3258955012013

PINÇA LONGA MODELO CURVO - 155 MM

- Pontas estriadas, curvas a 35°.
- Aço inoxidável, ligeiramente polido.
- Revestimento PVC azul.



E501202	L mm	Peso g	☒	EAN
E501202	155	44	1	3258955012020

PINÇA MODELO A DIREITO

- Pontas estriadas direitas.
- Aço inoxidável anti-magnético - anti-ácido.



E501203	L mm	Peso g	☒	EAN
E501203	120	12	1	3258955012037





ALICATES ELECTROTÉCNICOS

ALICATE DE PONTAS AFILADAS DIREITAS

- Pontas lisas para uma melhor protecção das peças.
- Pontas extra-finas para uma excelente acessibilidade
- Revestimento em bi-matéria macia para uma pega firme com a mão.



	L mm	Peso g		EAN
E117877	132	25	1	3258951178775



ALICATE DE PONTAS CHATAS

- Pontas estriadas para uma boa resistência de peça.
- Grande robustez das pontas.
- Revestimento em bi-matéria macia para uma pega firme com a mão.



	L mm	Peso g		EAN
E117883	137	20	1	3258951178836



ALICATE DE PONTAS AFILADAS CURVAS

- Pontas lisas para uma melhor protecção das peças.
- Pontas extra-finas para uma excelente acessibilidade.
- Revestimento em bi-matéria macia para uma pega firme com a mão.



	L mm	Peso g		EAN
E117878	133	35	1	3258951178782





ALICATES DE CORTE AXIAIS ROBUSTOS

- Cabeça ogival para uma melhor acessibilidade.
- Excelente polivalência de corte.
- Revestimento em bi-matéria macia para uma pega firme com a mão.



	L mm	d mm corda de piano	d mm cabo de aço	Peso g		EAN
E117879	115	0.8	1	64	1	3258951178799
E117880	110	0.5	0.8	64	1	3258951178805

ALICATE DE CORTE RASO FINO

- Ogiva compacta para uma perfeita acessibilidade.
- Corte limpo e preciso.
- Revestimento dupla matéria macia para um bom agarre na mão.

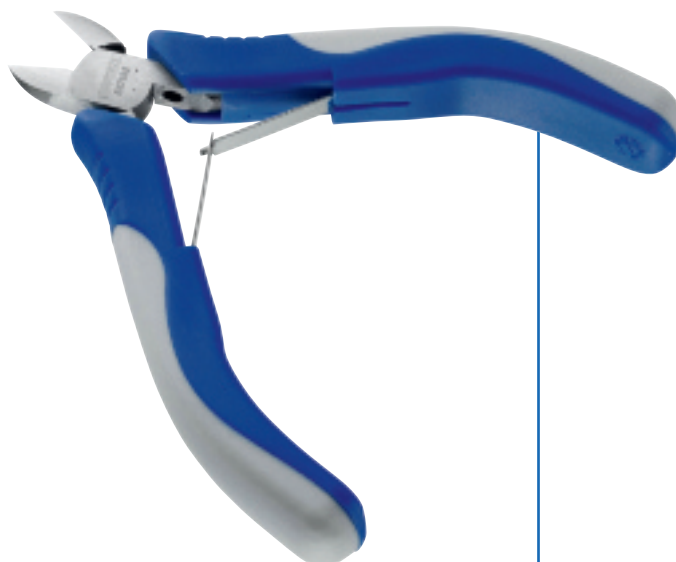

	L mm	Peso g		EAN
E117882	110	20	1	3258951178829



FERRAMENTAS AUTOMÓVEL





Equipamento de oficina

P.228



Mudança de óleo-filtros

P.232



Velas

P.237



Electricidade auto

P.239



Motor

P.243



Travões

P.248



Suspensão

P.250



Rodas

P.251



Carroçaria

P.255

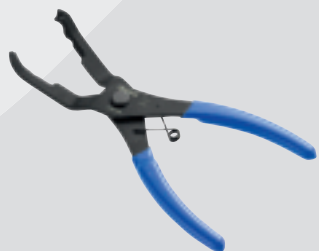

Pára-brisas

P.257





EQUIPAMENTO DE OFICINA

MACACO DE RODAS DE 3T

- Altura mínima ao solo 140 mm. Elevação máxima 520 mm.
- Rodas em metal.
- Conformidade CE.
- Dimensões: 720 x 345 x 185 mm.



E200141	Capacidade T	Peso kg		EAN
E200141	3	36,7	1	3258952001416

PULVERIZADOR PROFISSIONAL

- Função pulverizador .
- Até 3 bares de pressão.
- Capacidade de 5L .
- Escova para lavagem de carro.
- Depósito graduado.



E200140		EAN
E200140	1	3258952001409

TROLE DE 4 RODAS

- Capacidade de carga : 150 kg.
- Dobrável .
- Superfície antiderrapante .
- Rodas Castor .
- Dimensões: 815 x 738 x 479 mm.



E200135		EAN
E200135	1	3258952001355

CARRINHO DE PILHA

- Capacidade de carga : 200 kg.
- Rodar alças.
- Os pneus.
- Dimensões: 425 x 555 x 1.130 milímetros.



E200136		EAN
E200136	1	3258952001362



PAR DE PREGUIÇAS DE CREMALHEIRA

- Sistema de barra com cremalheira.
- Construção robusta e soldada.
- Base larga para maior estabilidade.

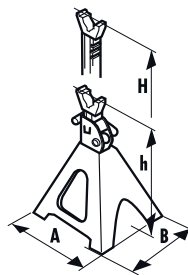

	Capacidade T	A mm	B mm	H mm	Peso kg	☒	EAN
E200143	3	206	188	423	6,40	1	3258952001430
E200144	6	294	262	620	13,7	1	3258952001447
E200145	12	382	336	770	32	1	3258952001454

PAD PROTEÇÃO NO JOELHO

- Duas luzes podem ser inseridas para iluminar a área de trabalho apropriada.
- Superfície tratada para resistir a líquidos e uso repetido.
- Alça de transporte.
- Tamanho adaptados para armazenamento em um saco de ferramenta de tecido.
- Dimensões: L.428 x D.250 x H.32 mm.



	Peso g	☒	EAN
E200131	160	1	3258952001317

CARRINHO DE INSPECÇÃO

- 6 rodas.
- Suporte cabeça espuma.
- 2 compartimentos de arrumação de ferramentas.
- Resistente aos hidrocarbonetos, lavável.
- Dimensões: 480 x 1030 x 115 mm.



	Peso kg	☒	EAN
E200114	4,6	1	3258952001140

JOGO DE 2 RODAS PARA CARRINHO DE INSPECÇÃO

- Para carrinho de inspeção E200114.



	Peso g	☒	EAN
E200124	190	1	3258952001249





EQUIPAMENTO DE OFICINA

PROTEÇÃO DE GRELHA

- Prática: calha integrada porta-ferramentas.
- Evita os riscos na carroçaria.
- Vinilo espesso resistente aos hidrocarbonetos.
- Dimensões: L.86 x C.66 cm.



	Peso g		EAN
E200116	700	1	3258952001164

EXTRACTOR DE LÍQUIDOS

- Capacidade: 9,5 L.
- Adequado para a extracção de lubrificantes.
- Bomba pneumática (utilização em oficina) ou manual (utilização em reparação).
- Corpo transparente.
- Sem manutenção.
- Com 4 pontas.
- Fornecido com manual.



	Peso kg		EAN
E200512	4,51	1	3258952005124

ALAVANCAS DE ESFORÇO

- Forjado a partir de aço em liga de cromo.
- A forma da cabeça funciona como um ponto de apoio para aumentar o esforço.

	L mm	Peso g		EAN
E150901	300	234	1	3258951509012
E150902	413	480	1	3258951509029

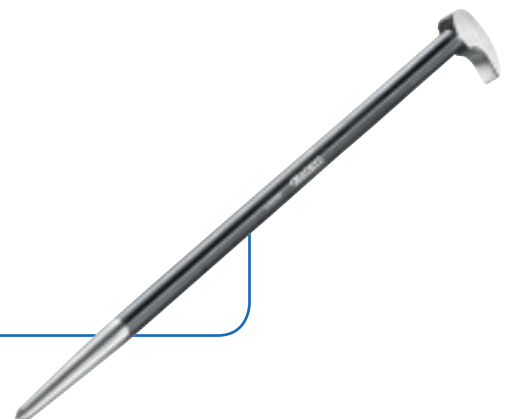



ESPELHO LED TELESCÓPICO

- Dupla iluminação LED.
- Tamanho expansível: 290 a 876 mm.
- Cabeça rotativa e ângulo adaptável.
- 1 pilha plana 3V de lítio fornecida.



	Peso g		EAN
E051401	115	1	3258950514017

ESPELHO TELESCÓPICO 2 EM 1

- Ferramenta 2 em 1, espelho - dedo magnético.
- Tamanho extensível: de 200 a 690 mm.
- Diâmetro do espelho: 35 mm.
- Ponta magnética.



	Peso g		EAN
E051402	46	1	3258950514024

DEDO MAGNÉTICO FLEXÍVEL

- Cabo ergonómico de dupla matéria confortável e eficaz.
- Braço flexível de 409 mm.
- Ímã forte que consegue levantar até 1,4 kg.



	Peso g		EAN
E051501	222	1	3258950515014

GARRA MAGNETICA FLEXIVEL COM LED

- 252 milímetros braço flexível.
- 4 garras.
- Iluminação LED.
- Poderoso bit magnético.
- 3 baterias LR44 fornecido.



	Peso g		EAN
E201414	180	1	3258952014140





MUDANÇA DE ÓLEO-FILTROS

SERINGA PARA MUDANÇA DE ÓLEO

- Capacidade 1,5 litros.
- Adequada para a extração e a injeção de líquidos aquando da manutenção do veículo.
- Junta dupla para aspiração contínua.
- Torneira que permite manter a seringa cheia.
- Corpo transparente graduado.



E200231	Peso g	📦	EAN
E200231	900	1	3258952002314

RECIPIENTE PLÁSTICO

- Mangueira flexível.
- 2 caps.
- Pode ser usado com qualquer tipo de óleo.
- Graduado em litros e galões dos EUA.



E200244	📦	EAN
E200244	1	3258952002444

RECIPIENTE RECUPERADOR DO ÓLEO

- Capacidade 8 litros.
- Resiste aos choques e aos hidrocarbonetos.
- A utilizar quando se efectuar uma mudança de óleo no solo.



E200227	Peso g	📦	EAN
E200227	640	1	3258952002277

RECIPIENTE DE RECUPERAÇÃO E ARMAZENAMENTO DO ÓLEO DA MUDANÇA DE ÓLEO

- Capacidade 8 litros.
- Resiste aos choques e aos hidrocarbonetos.
- Indispensável quando é necessário transportar o fluido esvaziado.



E200228	Peso g	📦	EAN
E200228	790	1	3258952002284



FUNIL DE TORNEIRA

- Funil 1,2 L.
- Torneira de abertura e de fecho.
- Adaptado ao óleo do motor e da caixa de velocidades assim como ao líquido de refrigeração e ao combustível.
- Filtro amovível.



E200238	Peso g	☒	EAN
	200	1	3258952002383

FUNIL DE ÓLEO

- Criado para o abastecimento de óleo do motor.
- Forma retangular que permite deixar o bidão a escorrer.
- Igualmente adaptado ao óleo da caixa de velocidades assim como ao líquido de refrigeração e ao combustível.



E200237	Peso g	☒	EAN
	90	1	3258952002376

KIT DE REPARAÇÃO PARA CÁRTERES DE ÓLEO - 64 PEÇAS

- Criado para a reparação das roscas de cárteres de óleo danificadas.
- 64 peças:
- 4 machos: M13 - M15 - M17 - M20.
- 5 tampões por tamanho: M13.5 - M15.5 - M17.5 - M20.
- 10 anilhas em alumínio por tamanho: 13 - 15 - 17 - 20 mm.



E200236	Peso g	☒	EAN
	1410	1	3258952002369

CHAVE PARA BUJÕES

- Quadrados de 8 e 10 mm.
- Indispensável para PEUGEOT, CITROEN e RENAULT.



E200202	Peso g	☒	EAN
	300	8	3258952002024





MUDANÇA DE ÓLEO-FILTROS

JOGO DE 13 PONTAS DE MUDANÇA DE ÓLEO

- 6 x hexagonal macho 8 - 10 - 12 - 13 - 14 - 17 mm.
- 4 x quadrado macho 8 - 10 - 10,5 - 13,1 mm.
- 1 x quadrado fêmea.
- 1 x XZN®.
- 1 x triângulo.



	Quantidade	Peso g		EAN
E200203	13	450	3	3258952002031

PONTAS DE MUDANÇA DE ÓLEO 3/8" SEXTAVADAS MACHO

	A mm	Peso g		EAN
E200209	8	28	1	3258952002093
E200210	10	30	1	3258952002109
E200211	12	34	1	3258952002116
E200212	13	36	1	3258952002123
E200213	14	38	1	3258952002130
E200214	17	48	1	3258952002147



PONTAS DE MUDANÇA DE ÓLEO 3/8" QUADRADAS

	A mm	Peso g		EAN
E200204	8	30	1	3258952002048
E200205	10	32	1	3258952002055
E200206	10,50	34	1	3258952002062
E200207	13,10	38	1	3258952002079



PONTA DE MUDANÇA DE ÓLEO 3/8" QUADRADA FEMEA - 10 MM

	Peso g		EAN
E200208	32	1	3258952002086

PONTA DE MUDANÇA DE ÓLEO 3/8" XZN® MACHO - 16 MM

	Peso g		EAN
E200216	36	1	3258952002161



PONTA DE MUDANÇA DE ÓLEO 3/8" TRIANGULAR MACHO - 10 MM

	Peso g		EAN
E200215	26	1	3258952002154



MÓDULO DE ESPUMA DE MUDANÇA DE ÓLEO

- Módulo de espuma .
- Ferramentas essenciais para troca de óleo.
- 2 chaves para ser usado com qualquer tipo de filtros .
- 13 bits usados com catraca cabeça articulada.

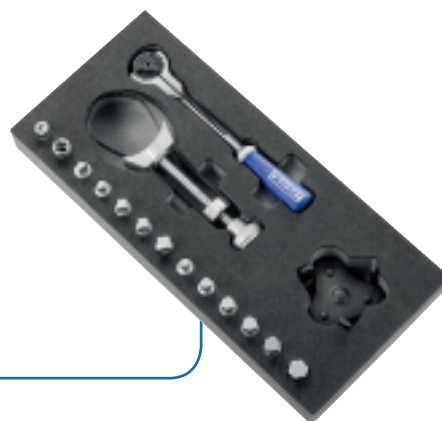

E200245	1	EAN
		3258952002451

CHAVE REGULÁVEL PARA FILTRO DE ÓLEO

- Para os filtros de 60 a 110 mm.
- Para a maioria dos filtros de óleo VL VUL.

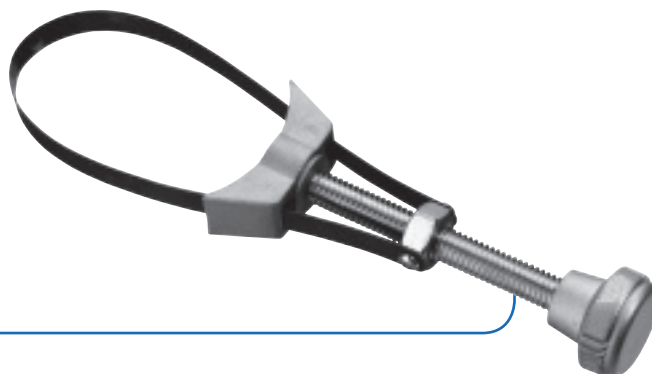

E117117	Peso g	10	EAN
	250		3258951171172

CHAVE REGULÁVEL PARA FILTRO DE ÓLEO - VP

- Para os filtros de 110 a 165 mm.
- Para a maioria dos filtros de óleo PL.



E200219	Peso g	1	EAN
	350		3258952002192

CHAVE DE CORRENTE PARA FILTROS DE ÓLEO

- ISO 1174 - DIN 3122



E200234	d max mm	Peso g	1	EAN
	120	260		3258952002345
E200235	160	315	1	EAN
				3258952002352





MUDANÇA DE ÓLEO-FILTROS

CHAVES “TIPO FÔRMA” PARA FILTROS DE ÓLEO

- 30 peças.
- Encaixe 3/8».
- Adaptador 3/8” a 1/2”.
- Filtro de auto-aperto universal incluído.
- Este jogo abrange 85% dos filtros de óleo de marcas dos grupos seguintes: PSA, RENAULT, FIAT, ALFA, LANCIA, VAG, BMW, MERCEDES, VOLVO, SAAB, ROVER, JAGUAR, LOTUS, TOYOTA, SUZUKI.



	Quantidade	Peso kg		EAN
E200201	30	7	1	3258952002017

CHAVE PARA “FILTRO” DE AUTO-APERTO UNIVERSAL

- Ø : 65-120 mm.



	Peso g		EAN
E200229	450	1	3258952002291

CAIXA DE 6 CHAVES DE CAIXA DE “FILTROS” EM ALUMÍNIO

- Coberturas para tampas de plástico de filtros de óleo.
- Encaixe 1/2».
- Perfil sextavado.
- Ø 24 - 27 - 30 - 32,5 - 36 - 38 mm.



	Peso g		EAN
E200239	500	1	3258952002390



VELAS

JOGO DE 6 CHAVES DE CAIXA PARA VELAS DE PRÉ-AQUECIMENTO

- 6 chaves de caixa para velas: Ø 8 - 9 - 10 - 12 - 14 - 16 mm.
- Cardan de fricção.
- Quadrado 3/8".



E200311	Peso g	☒	EAN
E200311	1615	1	3258952003113

CHAVES DE CAIXA PARA VELAS

- ISO 11168

	☒	d mm"	Pans	L mm	Peso g	☒	EAN
E200301	3/8"	14	12	63,50	75	1	3258952003014
E200302	3/8"	16	6	63,50	90	1	3258952003021
E200303	3/8"	21	6	70	120	1	3258952003038
E032401	1/2"	5/8"	6	63,50	100	1	3258950324012
E032402	1/2"	13/16"	6	70	160	1	3258950324029
E032101	1/2"	16	6	65	90	1	3258950321011
E032102	1/2"	21	6	70	120	1	3258950321028



APALPA FOLGAS - ESPESSURAS MÉTRICAS

- 19 lâminas de 0,04 a 1 mm.
- Comprimento 90 mm.

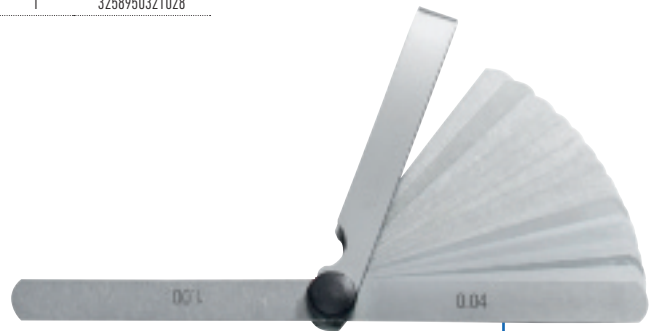

E200307	Peso g	☒	EAN
E200307	60	1	3258952003076

APALPA FOLGAS LONGOS MÉTRICOS

- 19 lâminas de 0,05 a 1 mm.
- Comprimento 150 mm.



E200312	Peso g	☒	EAN
E200312	172	1	3258952003120





CONJUNTO DE 4 PUXADORES DE BOBINAS DE IGNIÇÃO VAG

- Composição dos quatro grampos.
- Para extrair 99% de VAG as bobinas de grafite .
- Fornecido em caixa de plástico com instruções.



	Peso g		EAN
E200503	948	1	3258952005032

KIT DE REPARAÇÃO PARA VELAS DE IGNIÇÃO - 16 PEÇAS

- Criado para a reparação de rosca para velas de ignição.
- 1 macho escalonado M16 encaixe de 17.
- 5 aplicações rosca M14 x 125 - 11,2 mm.
- 5 aplicações rosca M14 x 125 - 17,5 mm.
- 5 aplicações rosca em latão M14 x 125 - 17,5 mm.



	Peso g		EAN
E200310	330	1	3258952003106

ESCOVA METÁLICA

- Pega anti-derrapante.



	Peso g		EAN
E200306	170	12	3258952003069



ELECTRICIDADE AUTO

BOOSTER 12 V

- Tensão: 12 V.
- Corrente de pico: 1600 A.
- Corrente de arranque: 440 A.
- Para motor a gasolina e diesel.
- Booster com adaptador Reino Unido: E200413.



	Peso kg		EAN
E200408	6	1	3258952004080

EXTRACTOR DE TERMINAIS DE BATERIA

- Igualmente adequado para os limpa-vidros com ou sem difusor de líquido lava-vidros integrado.
- Carga máxima: 4 KN.



	Peso g		EAN
E201512	296	1	3258952015123

PORTA-BATERIA UNIVERSAL

- Adapta-se a todos os tipos de baterias.
- Abertura máxima 190 mm.
- Pega confortável.
- Peso máximo suportado 27 kg.



	Peso g		EAN
E201808	532	1	3258952018087





PESA-ÁCIDO

- Medição da densidade do líquido da bateria.
- Leitura da densidade do líquido e da percentagem de carga.



E200405	Peso g		EAN
E200405	200	1	3258952004059

JOGO DE 19 FERRAMENTAS PARA EXTRACÇÃO DE FICHAS DE CONECTORES

- Ferramentas compatíveis com os novos conectores do grupo VW-Audi.
- Utilizáveis em: sensores de líquido de refrigeração, feixes de cablagem e conectores de centralinas.
- Preserva o fio e o terminal.
- Pegas serrilhadas.



E201801	Peso g		EAN
E201801	602	1	3258952018018

TERMÓMETRO INFRAVERMELHOS

- Permite a medição por infravermelhos da temperatura sem contacto com a mira laser.
- Permite verificar a temperatura do motor, dos discos dos travões, do catalisador ou até de um sistema de ar condicionado.
- Medições: -20°C a 520°C
- Relação D/S (distância/superfície): 8/1.
- Possibilidade de desativar o laser.
- Seleção dos valores em graus Celsius ou Fahrenheit.
- Ecrã retroiluminado.
- Entregue com manual de utilização e pilha de 9V.



E201805	Peso g		EAN
E201805	135	1	3258952018056

TESTADOR DE BATERIA

- Conectando grampos nos terminais da bateria.
- Ajustamento CCA com base no valor indicado na bateria.
- Carregamento com o botão LOAD e lendo o valor diretamente na tela.
- LED verde (BOM) : Value > 10.8V.
- LED amarelo (LOW) : 10.8V > value > 9.1.
- LED vermelho (BAD) : 9.1V > valor.



E200407		EAN
E200407	1	3258952004073



MULTÍMETRO DIGITAL

- Indispensável para os diagnósticos das avarias eletrónicas.
- Voltímetro DC/AC: 0 a 250 V.
- Ohmímetro: 0 a 20 MΩ.
- Teste díodo: 2,8 V/1 mA.
- Ecrã LCD retroiluminado.
- Medição da resistência interna das baterias.
- Proteção contra as sobrecargas.
- Medição da temperatura.
- Colocação sem tensão automática.
- Verificador de polaridade.
- IEC-61010/CAT II 250 V/Norma CE.
- Entregue com 3 pilhas AAA 1,5 V.
- Entregue com cabos.

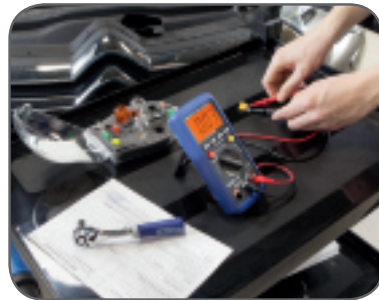

E051301	Peso g	📦	EAN
E051301	323	1	3258950513010

MULTÍMETRO DE PINÇA

- Ideal para a manutenção itinerante.
- Voltímetro AC: 0 a 600 V.
- Amperímetro DC: 0 a 400 A.
- Ohmímetro: 0 a 20 MΩ.
- Continuidade: < 30 Ω.
- Diâmetro máximo de cabo mensurável: \varnothing 32 mm.
- Medição das correntes sem contacto legível no ecrã LCD.
- Teste díodos.
- Função de armazenamento de dados.
- Proteção contra as sobrecargas.
- IEC-61010/RMS CAT III 600 V/Norma CE.
- Entregue com bolsa de proteção e cabos.



E201803	Peso g	📦	EAN
E201803	325	1	3258952018032





APARELHO DE TESTE MULTIFUNÇÕES

- Aparelho que permite um ganho de tempo para o diagnóstico dos sistemas elétricos dos automóveis graças às várias funcionalidades e aplicações.
- Teste de continuidade/Teste de polaridade.
- Medição da tensão DC de 2V a 24V.
- Verificação dos componentes, motores elétricos (elevadores de vidros, motor do limpa-pára-brisas, motor de arranque...) e das luzes.
- Monitorização e localização dos curtos-circuitos.
- Detecção dos maus contactos.
- Alimentação e utilização por ligação à bateria do veículo.
- Proteção contra a sobrecorrente.
- IEC 61326/EMC/Norma CE.
- Entregue com uma capa de proteção.



E201806	Peso g		EAN
E201806	548	1	3258952018063

APARELHO DE TESTE VAT

- Permite verificar a ausência de tensão num circuito antes de iniciar os trabalhos.
- Sistema de arrumação das ponteiras de contacto.
- Distância entre ponteiras de contacto de 19 mm (tomada de corrente).
- Teste de polaridade: LED +/-.
- Tensões: 6-12-24-50-120-230-400 V.
- DC/AC: 50-60 Hz.
- IP 54.
- IEC 61243-3/CAT III 600 V/Norma CE.
- 2 pilhas LR44 1,5 V fornecidas.



E201804	Peso g		EAN
E201804	176	1	3258952018049

VERIFICADOR DE TENSÃO

- Ideal para a verificação dos circuitos, fusíveis, interruptores e a cablagem nos automóveis, atrelados, barcos, motos e outros sistemas de baixa tensão.
- Ligue a pinça crocodilo à terra, de seguida, teste com a ponteira de contacto.
- Lâmpada no cabo que indica a presença de tensão.



E201802	Peso g		EAN
E201802	220	1	3258952018025



MOTOR

ALICATES PARA ABRAÇADEIRAS DE AUTO-APERTO

- E200504: alicate para abraçadeiras com cabo.
- E200505: alicate para abraçadeiras de 45° bloqueável e mordentes giratórios.
- E200506: alicate para abraçadeiras bloqueável e mordentes giratórios.
- E200507: alicate para abraçadeiras Clic.
- E200508: alicate de pontas chatas para extrair os tubos.
- E200509: alicate para abraçadeiras standard mordentes giratórios com rasgo.
- E200510: alicate para abraçadeiras standard mordentes giratórios com rasgo cruzado.

	Peso g	☒	EAN
E200504	470	1	3258952005049
E200505	240	1	3258952005056
E200506	235	1	3258952005063
E200507	230	1	3258952005070
E200508	200	1	3258952005087
E200509	245	1	3258952005094
E200510	205	1	3258952005100



JOGO DE 7 ALICATES PARA ABRAÇADEIRAS DE AUTO-APERTO

- Contém os 7 alicates disponíveis para a unidade: E200504-E200505-E200506-E200507-E200508-E200509-E200510.
- Fornecido em caixa plástica.



	Peso kg	☒	EAN
E200501	3,10	1	3258952005018

CHAVES DE CAIXA COM CABO FLEXÍVEIS

- Chaves de caixa com cabo sextavadas.
- Cabo ergonómico de dupla matéria confortável e eficaz.
- Lâmina flexível.
- Para o desaperto e aperto das braçadeiras de tubos flexíveis.



	Dimensions	Peso g	☒	EAN
E200524	6 x 150 mm	150	1	3258952005247
E200525	7 x 150 mm	150	1	3258952005254
E200526	8 x 150 mm	160	1	3258952005261





MOTOR

JOGO DE DOIS ALICATES COM TUBOS FLEXÍVEIS

- Permitem apertar rapidamente os tubos flexíveis sem os danificar.
- Estrutura em plástico.

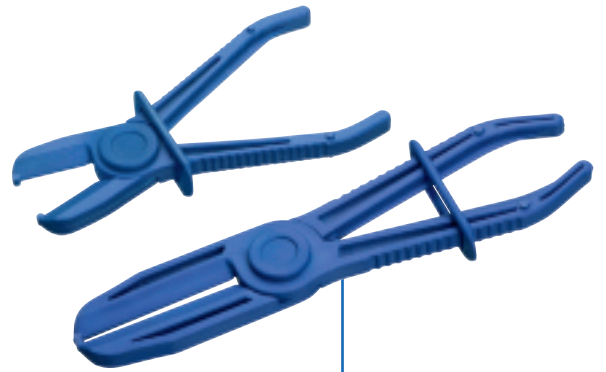

	Peso g		EAN
E201701	270	1	3258952017011

ALICATE PARA TUBOS FLEXÍVEIS DE COMBUSTÍVEL

- Ferramenta específica para desacoplar os conectores de filtros de combustível em linha.
- Ponta angular para um melhor acesso.

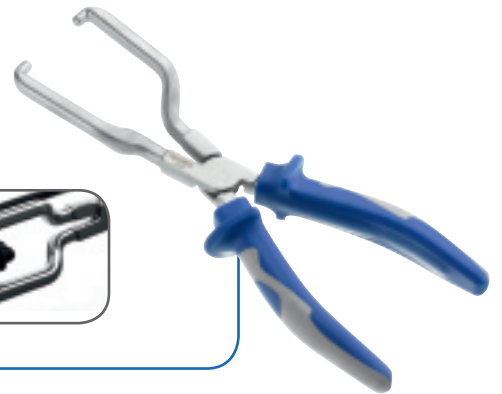

	Peso g		EAN
E200519	310	1	3258952005193

CHAVES DE CAIXA ABERTAS DESCENTRADAS

- Chaves de caixa 1/2" abertas descentradas 12 - 14 - 16 - 17 - 18 - 19 mm.
- Comprimento 100 mm para atingir as porcas de alimentação de injectores diesel em espaços confinados.



	Peso g		EAN
E200517	1200	1	3258952005179

FERRAMENTA DE SANGRAMENTO PARA INJEÇÃO DIESEL

- Para sangrar as linhas de combustível diesel, os filtros e as bombas.
- Pera manual de escorvamento.

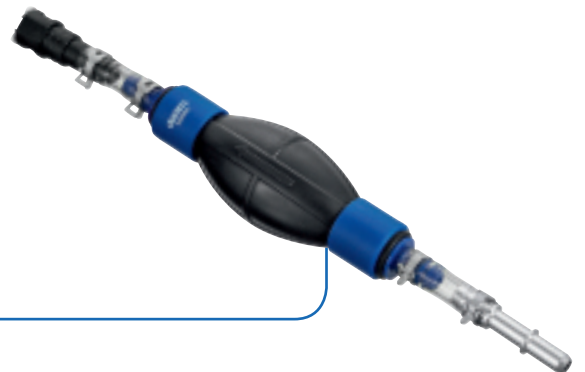

	Peso g		EAN
E200521	200	1	3258952005216



KIT APARELHO DE TESTE DO SISTEMA DE REFRIGERAÇÃO

- Kit completo para a detecção de fugas nos sistemas de refrigeração.
- Inclui adaptadores com uniões rápidas compatíveis com a maioria das viaturas europeias e japonesas.
- Adaptadores genéricos que permitem a utilização numa vasta gama de veículos e sistemas.
- Fornecido em caixa plástica com manual.



E200511	Peso kg	☒	EAN
E200511	3,9	1	3258952005117

RECIPIENTE DE RECUPERAÇÃO DO LÍQUIDO DE REFRIGERAÇÃO

- Altura reduzida: pode facilmente deslizar sob a viatura.
- Capacidade 30 litros.
- Dimensões: L.850 x C.600 x A.125 mm.



E200502	Peso kg	☒	EAN
E200502	6	1	3258952005025

JOGO DE 8 PINÇAS DE OBTURAÇÃO

- Ideal para as intervenções nos circuitos de combustível, travões e climatizações.
- 2 x Banjos (dois tamanhos)
- 2 x 3/8".
- 2 x 1/2".
- 2 x 5/16".
- Evita o escoamento dos líquidos e a contaminação do circuito devido a impurezas.
- 3 posições de abertura reguláveis para se adaptar a qualquer tipo de tubos e uniões.
- Entregue com pontas sobresselentes.

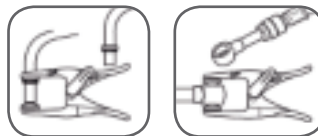

E201702	Peso g	☒	EAN
E201702	1000	1	3258952017028

PESA-ANTICONGELANTE

- Verifique a qualidade e a temperatura de congelação do líquido de arrefecimento do motor.
- Teste quente e frio.
- Leitura em graus Celsius e Fahrenheit.



E200523	Peso g	☒	EAN
E200523	200	1	3258952005230





MOTOR

CHAVE DE APERTO ANGULAR COM FLEXÍVEL MAGNÉTICO

- Quadrado 1/2".
- Braço flexível de 340 mm.
- Ponto fixo por flexível com íman.
- Graduação 2°.



E100115	Peso g		EAN
E100115	257	1	3258951001158

CHAVE DE APERTO ANGULAR COM BARRA

- Quadrado 1/2".
- Haste de fixação 100 mm x 50 mm
- Graduação 2°.



E100116	Peso g		EAN
E100116	180	1	3258951001165

JOGO DE 2 RODA-VÁLVULAS

- Cabo de madeira com ventosas em cada extremidade.
- 1 x L.245 mm com ventosas de \varnothing 19 e 22 mm.
- 1 x C.255 mm com ventosas de \varnothing 22 e 32 mm.



E200518	Peso g		EAN
E200518	100	1	3258952005186

ESTETOSCÓPIO

- Concepção monobloco que dispõe de um diafragma ultra fino para ajudar a localizar a fonte do ruído.
- Entregue com agulha.



E200520	Peso g		EAN
E200520	190	1	3258952005209



CAIXA PARA POLIE DE ALTERNADOR - 13 PEÇAS

- Para a montagem e desmontagem da polia do alternador.
- Chaves de caixa combinadas 1/2".
- Torx®: T50.
- XZN®: M10.
- Pontas 10 mm:
- Torx®: T40-T50, C.75 mm.
- XZN®: M8-M10, C.75 mm.
- Sextavada: 8-10, C.75 mm.
- Porta-pontas aparafusadoras 1/2" - 10 mm.
- 2 aplicações corrediças denteado múltiplo 33 dentes.
- 1 aplicação corrediça hexagonal de 17 mm.
- 1 aplicação corrediça de 4 pinos.



E201901	Peso g	📦	EAN
E201901	1366	1	3258952019015

CAIXA PARA POLIE DE ALTERNADOR - 22 PEÇAS

- Kit completo para a montagem e desmontagem da polia do alternador.
- Chaves de caixa combinadas:
- Torx®: T50 1/2".
- XZN®: M10 1/2" - M10 3/8".
- Chave de caixa XZN® 1/2" M10
- Pontas 10 mm:
- Torx®: T40-T50, C.75 mm.
- XZN®: M8-M10, C.75 mm.
- Sextavada: 8-10, C.75 mm.
- Porta-pontas aparafusadoras 1/2" - 10 mm.
- 3 aplicações corrediças denteado múltiplo 33 dentes.
- 5 aplicações corrediças hexagonais de 17-19-21-22-27 mm.
- 2 aplicações corrediças de 3 e 4 pinos.



E201902	Peso g	📦	EAN
E201902	2510	1	3258952019022

ALICATE DE DESMONTAGEM SILENT-BLOCS DE ESCAPE

- Alicate especial para a desmontagem dos silent-blocs de escape.
- Acesso mesmo nas zonas difíceis.
- Ferramenta adaptada a uma grande gama de VL e VUL.



E200601	Peso g	📦	EAN
E200601	430	1	3258952006015





TRAVÕES

DISPOSITIVO DE TESTE DO LÍQUIDO DOS TRAVÕES

- Mede a percentagem de humidade do líquido dos travões em relação à norma.
- O aparelho de teste envia uma corrente fraca no líquido dos travões e mede a sua resistência.
- 2 escalas de leitura: DOT 4 e DOT 5.1.
- Sonda de medição extensível até 1,5 metros.
- Bateria: pilha de 9 V tipo LR622 (não fornecida).
- Teste de desgaste da pilha por díodo.
- Entregue em caixa plástica com manual.



E200903	Peso g		EAN
E200903	750	1	3258952009030

PURGADOR DE TRAVÃO DE DEPRESSÃO

- Purgador por depressão que funciona através do princípio de Venturi.
- Pressão de utilização 6-10 bars.
- Utilização VL, moto.
- Utilizável para travão ou embraiagem.
- Capacidade 3L.
- Manómetro que indica o valor de depressão.
- Ponta de borracha: E200909.



E200901	Peso kg		EAN
E200901	1	1	3258952009016

PURGADOR DE TRAVÃO DE DEPRESSÃO

E200909		EAN
E200909	1	3258952009092

BOTIJA DE ENCHIMENTO DEPÓSITO

- Permite um enchimento automático.
- Adaptação em todos os diâmetros de depósito de óleo dos travões.
- Capacidade 1 L.
- Torneira de fecho.



E200902	Peso kg		EAN
E200902	0,60	1	3258952009023

SERINGA PARA MUDANÇA DE LÍQUIDOS

- Capacidade de 0,2 L.
- Adequada para a extracção e a injeção de líquidos aquando da manutenção do veículo.
- Corpo transparente.
- Junta dupla para aspiração contínua.
- Ideal para o líquido de travões e anticongelante.

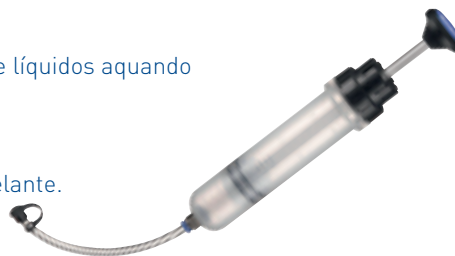

E200907	Peso g		EAN
E200907	290	1	3258952009078



ESCOVA PARA TRAVÕES

- Remove a poeira e sujeira de pinças de travão.
- Comprimento: 220 milímetros.



E200911		EAN
1	3258952009115	

BRAKE TESTADOR DE FLUIDO

- Permite ao usuário verificar rapidamente a percentagem de umidade no fluido de freio.
- Os resultados indicaram sobre o produto por LEDs .
- Entregue com uma pilha AAA.



E200910		EAN
1	3258952009108	

COMPOSIÇÃO PARA REPOSICIONAR ÊMBOLOS DE TRAVÕES

- Permite reposicionar os êmbolos ao rodar para a esquerda ou para a direita.
- Entregue com 21 adaptadores de todas as marcas (lista de aplicação no manual).
- Fornecida em caixa plástica com manual.



E200904	Peso kg		EAN
2,63	1	3258952009047	

CAIXA DE CHAVES DE PANCADA - 12 PEÇAS

- Desbloqueio rápido e com toda a segurança dos parafusos gripados, enferrujados ou colados.
- Entregue em caixa metálica.
- 12 Peças (conteúdo detalhado página 129).



E230301	Peso g		EAN
1250	1	3258952303015	

FERRAMENTAS PARA ABOCARDAR TUBOS

- Para trabalhar no tubo Ø 4,75 mm.
- Forma DIN ou SAE (tubo liga cobre).
- Concebido para abocardar directamente no veículo sem desmontagem da tubagem.
- Utilização fácil, utiliza-se com uma chave de aperto standard.
- Fornecido em caixa plástica com manual.



E200905	Peso kg		EAN
1,40	1	3258952009054	





TRAVÕES

PAQUÍMETRO PARA DISCOS DE TRAVÃO

- Mede a espessura dos discos de travão e o desgaste dos pneus.
- Uma alavanca permite soltar a maxila de medição mantendo a cota pretendida quando se formam rebarbas exteriores no disco.
- Escala métrica com graduações de 0,1 mm.
- Intervalo de medição: 0 a 60 mm.



E200908	Peso g		EAN
	56	1	3258952009085

CHAVE ABERTA

- Concebida para os tubos de travões.
- 6 faces: 10 x 11 mm.



E200906	Peso g		EAN
	110	1	3258952009061

SUSPENSÃO

COMPRESSOR DE MOLA

- 3 pares de garras equipadas com uma proteção plástica intermutável para evitar danificar a pintura da mola.
- Comprimento do corpo: 453 mm.
- Curso de compressão: 300 mm.
- Potência máxima: 10200 N (cerca de 1 tonelada).
- Encaixe sextavado 24 mm.
- Entregue com acessórios de adaptação para mola cónica.
- Entregue em caixa plástica com manual.

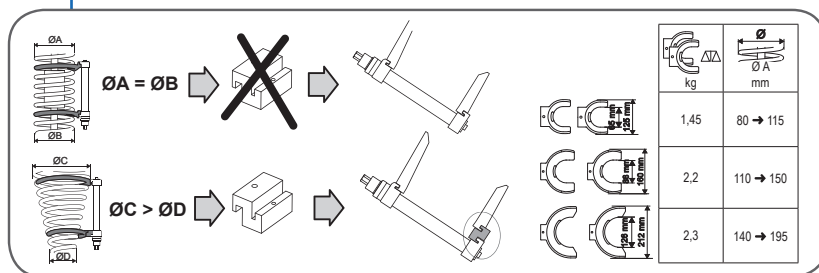

E201001	Peso kg		EAN
	14,30	1	3258952010012

PEÇAS SOBRESSELENTES PARA COMPRESSOR DE MOLA

- E201002: jogo de 3 pares de protecções plásticas.
- E201003: jogo de 5 cavilhas de segurança.

E201002		EAN
	1	3258952010029
E201003		EAN
	1	3258952010036



RODAS

ALAVANCAS DESMONTA-PNEUS

- E201117: modelo a direito.
- E201118: modelo curvo
- Acabamento: fosfato.



	L mm	Peso kg		EAN
E201117	500	1.25	1	3258952011170
E201118	728	1.47	1	3258952011187

FERRAMENTA REVERSÍVEL DESMONTA-INTERIOR DE VÁLVULA

- Cabo plástico adaptado para jantes em alumínio.
- Comprimento 285 mm.



	Peso g		EAN
E201119	80	1	3258952011194

FERRAMENTA REVERSÍVEL DESMONTA-INTERIOR DE VÁLVULA

- Cabo plástico adaptado para jantes em alumínio.
- Comprimento 285 mm.



	Peso g		EAN
E201109	40	1	3258952011095

DESMONTA-INTERIOR DE VÁLVULA DE AR CONDICIONADO + RODA

- Ferramenta 2-em-1:
- Um lado para a desmontagem e a substituição do interior da válvula de roda.
- Adequada para os VUL e motos.



	Peso g		EAN
E201110	40	1	3258952011101

ALICATE PARA PESOS DE CALIBRAGEM

- Para colocar ou retirar os pesos de calibragem das rodas.

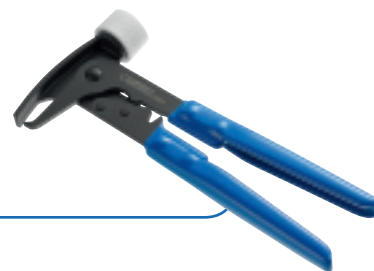

	Peso g		EAN
E201112	510	1	3258952011125

MÓDULO DE ESPUMA DE RODAS

- Módulo de espuma com as principais ferramentas para desmontar uma roda e um pneu.
- 1/2" chave de impacto Compact .
- Jogo de 3 chaves.
- 2 ferramentas de válvulas.
- Alicates de balanceamento.



	Peso g		EAN
E201125	46	1	3258952011255





RODAS

APARELHO DE TESTE DA PRESSÃO DE PNEUS

- Visualização da pressão no ecrã retroiluminado.
- Unidades de medição em: 3.0 - 99.5 PSI - 0.2BAR - 6.86 BAR - Kpa - Kg/cm.
- Precisão de 0,01.
- Batímetro graduado de 0 a 20 mm para verificar o desgaste dos pneus.
- Norma CE.
- 2 pilhas botão LR44 1,5 V fornecidas.



	Peso g		EAN
E201120	97	1	3258952011200

JOGO DE 3 CHAVES DINAMOMETRICAS PRÉ- REGULADAS

- Força pré - regulada para a montagem de rodas.
- Dimensões: 90 N.m - 110 N.m - 120 N.m.



	Peso g		EAN
E100114	6	1	3258951001141

CHAVES DE CRUZETA PORCAS DAS RODAS

- Chaves adaptadas à desmontagem das porcas de roda para veículos de turismo utilitários e veículos pesados.



		Dimensões	Peso kg		EAN
E201115	1/2"	17 x 19 x 22	1,4	1	3258952011156
E201116	3/4"	24 x 27 x 32	4,5	1	3258952011163

CHAVES PARA PORCAS DE RODAS DE CAMIÃO

- ISO 1711 - ISO 2725.
- Acabamento fosfato.

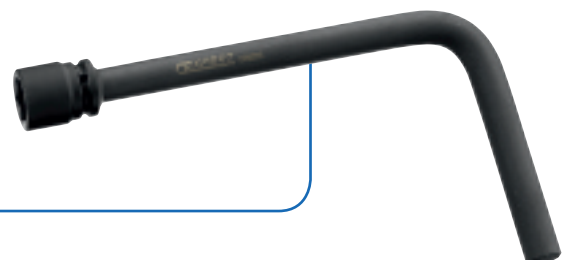

	Nº	L mm	L1 mm	Peso g		EAN
E201122	27	367	215	2,5	1	3258952011224
E201123	32	372	215	2,73	1	3258952011231
E201124	33	372	215	2,73	1	3258952011248



JOGO DE 3 CHAVES DE CAIXA HELICOIDAIS - 1/2"

- Ideal para retirar as porcas e os parafusos danificados.
- Perfil interior helicoidal.
- Dois perfis por chave de caixa:
- Chave de caixa 1/2" de impacto 17 mm.
- Chave de caixa 1/2" de impacto 19 mm.
- Chave de caixa 1/2" de impacto 21 mm.
- Adaptador 1/2" para chave de caixa.



E201105	Peso g	📦	EAN
E201105	730	1	3258952011057

JOGO DE CHAVES DE CAIXA JANTES DE LIGA 17, 19, 21 MM - QUADRADO 1/2"

- Protecção de plástico exterior para proteger as jantes de liga.



E194676	Quantidade	Peso kg	📦	EAN
E194676	3	0,65	1	3258951946763

CHAVE DE CAIXA DE IMPACTO XZN® M18 1/2"

- XZN® M18, C.78 mm
- Para Volkswagen e Audi e outras aplicações gerais.



E201121	Peso g	📦	EAN
E201121	150	1	3258952011217

JOGO DE 3 EXTRATORES DE RÓTULA DE DIREÇÃO

- 1 modelo para rótula Ø 24 mm.
- 1 modelo para rótula Ø 28 mm.
- 1 modelo para rótula Ø 34 mm.
- Fornecido em caixa plástica com manual.



E201100	Quantidade	Peso kg	📦	EAN
E201100	3	3	1	3258952011002





RODAS

KIT EXTRACTOR DE ROLAMENTO - TODAS AS MARCAS

- Kit de extracção de rolamento de 1ª geração (60 - 85 mm).
- Centragem e alinhamento exacto para não danificar o rolamento.
- Adequado para a maioria dos modelos VW, Audi, Seat, Fort, Opel e BMW.
- Fornecida em caixa plástica com manual.

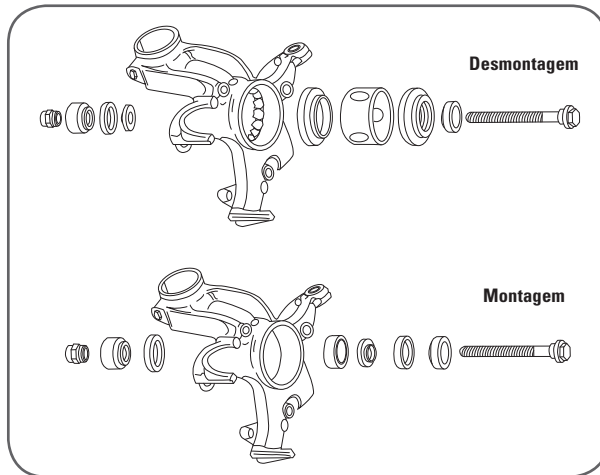

E201113	Peso kg	📦	EAN
E201113	10	1	3258952011132

KIT EXTRACTOR DE ROLAMENTO - VIATURAS FRANCESAS

- Kit de extracção de rolamento principalmente dedicado às marcas francesas.
- Centragem e alinhamento exacto para não danificar o rolamento.
- Adequado para a maioria dos modelos Peugeot, Citroën e Renault.
- Fornecida em caixa plástica com manual.

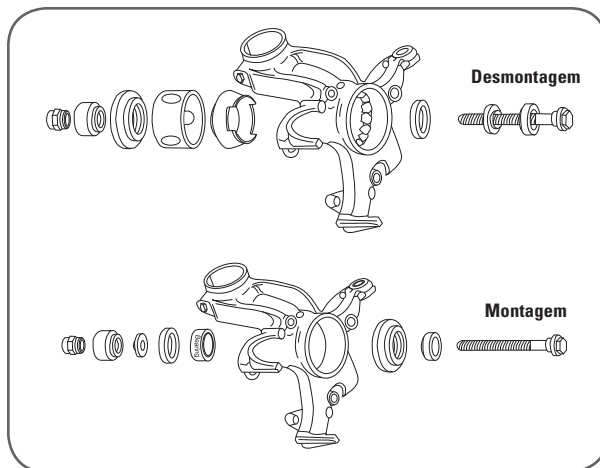

E201114	Peso kg	📦	EAN
E201114	13	1	3258952011149



CARROÇARIA

ALICATE DESAGRAFADOR

- Facilita o acesso para a extracção dos clips em locais confinados.
- Evita danificar o clip.



E201201	Peso g		EAN
E201201	240	1	3258952012016

ALICATE CURVO PARA CLIPS

- Facilita o acesso para a extracção dos clips em locais confinados.
- Ideal para retirar as espumas e os revestimentos isolantes.
- Evita danificar o clip.



E201202	Peso g		EAN
E201202	150	1	3258952012023

JOGO DE 6 FERRAMENTAS PARA DESMONTAR GUARNIÇÕES

- Gama de ferramentas que permite desmontar ou desengatar as peças de plástico sem as deteriorar.



E201203	Peso g		EAN
E201203	285	1	3258952012030

JOGO DE 4 RASCADORES EM PLÁSTICO

- Gama de ferramentas que permite retirar os revestimentos, autocolantes na carroçaria e resíduos em jantes de liga.
- 4 larguras: 20 - 23 - 25 - 38 mm.



E201204	Peso g		EAN
E201204	515	1	3258952012047





CARROÇARIA

ALMOFADA ABRE-PORTAS INSUFLÁVEL

- Permite a abertura controlada das portas autochaves.
- Evita os riscos e os danos inúteis.
- Sistema de enchimento por pera.



E201207	Peso g		EAN
E201207	200	1	3258952015222

KIT DE ABERTURA DE PORTAS - 9 PEÇAS

- 9 ferramentas para abrir a porta de um veículo, cujas chaves se encontram no interior, sem partir o vidro.
- Utilização estritamente reservada aos profissionais.
- Entregue em estojo sem manual.

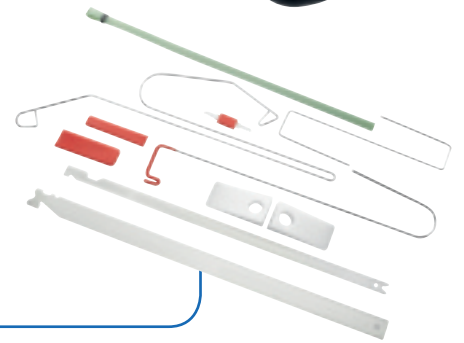

E201206	Peso g		EAN
E201206	665	1	3258952012061

BANCO

- Usado para reparar a carroçaria, bem como operações de pára-brisa.
- Capacidade: 115 kg.
- Dobrável.



E200137		EAN
E200137	1	3258952001362

CAVALETE DE CARROÇARIA

- Capacidade de carga: 226 kg.
- Chains fixar e ajustar a abertura.
- Dobrável.



E201211		EAN
E201211	1	3258952012115

JOGO DE 12 FERRAMENTAS PARA A MANUTENÇÃO DE AIRBAGS

- Jogo completo de ferramentas para a desmontagem e a instalação de airbags no veículo.
- 5 chaves de caixa 1/4" sextavadas de 80 mm de comprimento para alcançar as fixações.
- 7 ferramentas dedicadas à montagem e desmontagem de airbags.



E201205	Peso g		EAN
E201205	810	1	3258952012054



PÁRA-BRISAS

SUPOORTE MÓVEL PARA PÁRA-BRISAS

- 4 suportes de borracha para retirar facilmente o pára-brisas sem o danificar.
- Utiliza-se com todos os tipos de pára-brisas.
- Pode servir de suporte para peças de carroçaria tipo capot ou porta traseira.
- 3 prateleiras com rebordos que podem suportar até 50 kg cada.
- 4 rodas giratórias das quais duas com travões.
- Fácil e rápido de posicionar.
- Entregue não montado e com manual de montagem.



	L mm	H mm	Peso kg	☒	EAN
E201521	770	1005	11,4	1	3258952015215

JOGO DE 2 PARES DE VENTOSAS + CORREIA PARA PÁRA-BRISAS

- 2 pares de ventosas de Ø 117 mm.
- Par de ventosas capaz de suportar até 40 kg.
- Cinta incluída que permite posicionar o pára-brisas.



	Peso kg	☒	EAN
E201501	1,78	1	3258952015017

PAR DE VENTOSAS

- Par de ventosas de Ø 117 mm.
- Capaz de suportar até 40 kg.

	Peso g	☒	EAN
E201502	750	1	3258952015024

CINTA DE ROQUETE

- Utilizada com os pares de ventosas para o posicionamento do pára-brisas.



	Peso g	☒	EAN
E201503	285	1	3258952015031





PÁRA-BRISAS

JOGO DE 6 VENTOSAS DE FIXAÇÃO DE PÁRA-BRISAS

- Ventosas de Ø 78 mm.
- Indispensável para fixar os revestimentos de carroçaria ou o pára-brisas durante as operações de colagem.
- Regulação por sistema de parafuso.



E201507	1	EAN	3258952015079
---------	---	-----	---------------

VENTOSA DE BOMBA PL

- Ventosa de bomba de Ø 254 mm.
- Capaz de suportar até 130 kg.
- Indicador de fuga de vácuo.
- Botão de desbloqueio rápido de aspiração.

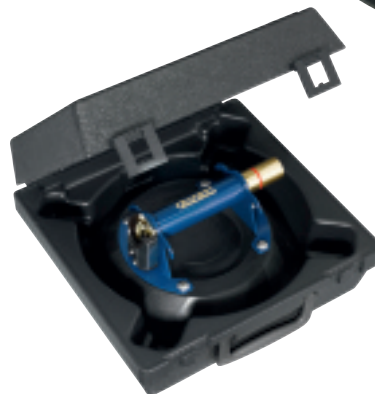

E201504	Peso kg	1	EAN	3258952015048
---------	---------	---	-----	---------------



VENTOSA MULTIUSOS

- Ventosa de Ø 55 mm.
- Capaz de suportar até 10 kg.
- Sistema de ventosa produzido por aperto das 2 pegas entre si.
- Utilizável com uma mão.



E201505	Peso g	📦	EAN
E201505	380	1	3258952015055

MINI VENTOSA MULTIUSOS

- Ventosa de Ø 23 mm.
- Capaz de suportar até 5 kg.
- Ideal para os pequenos vidros como os espelhos retrovisores.



E201508	Peso g	📦	EAN
E201508	65	1	3258952015086

JOGO DE VENTOSAS DE FIXAÇÃO DE VIDROS LATERAIS

- Ventosas de Ø 78 mm.
- Ventosas ligadas por um cabo revestido de 400 mm para evitar deteriorar a pintura.
- Fixação da janela lateral durante os trabalhos no mecanismo de vidro.
- Permite ter as mãos-livres aquando da utilização.

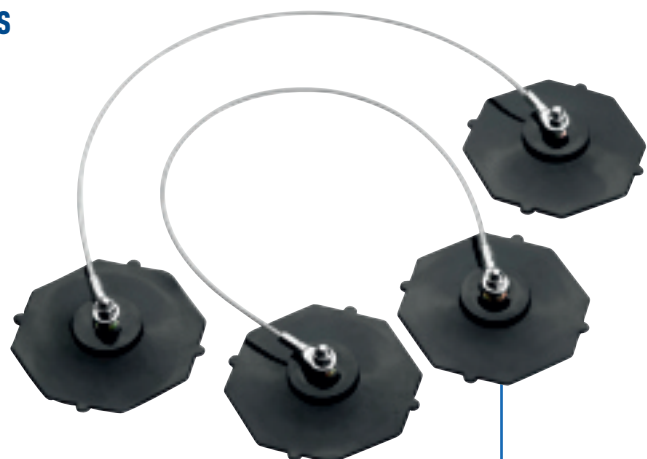

E201506	Peso g	📦	EAN
E201506	110	1	3258952015062





PÁRA-BRISAS

JOGO DE 3 FERRAMENTAS PARA SENSORES DE CHUVA E DE LUMINOSIDADE

→ Jogo de 3 ferramentas que permite retirar facilmente e sem deterioração os sensores de chuva e de luz no pára-brisas.



	Peso g		EAN
E201509	425	1	3258952015093

EXTRACTOR DE ESCOVAS LIMPA-VIDROS

- Para os limpa-vidros com ou sem difusor de líquido lava-vidros integrado.
- Igualmente adequado para a extracção de terminais de bateria.
- Capacidade de 4 KN.



	Peso g		EAN
E201512	296	1	3258952015123

EXTRACTOR PARA ESCOVAS LIMPA-VIDROS

- Permite a extracção de escovas limpa-vidros sem deterioração.
- Para VL e VUL.
- Carga máxima: 200 kg.
- Capacidade de 2 KN.



	Peso g		EAN
E201510	140	1	3258952015109



AGULHA DE INTRODUÇÃO

- Lâmina plana com corte de frente que permite introduzir o fio de corte através da junta de pára-brisas.
- Pega em T em plástico para mais conforto e potência.

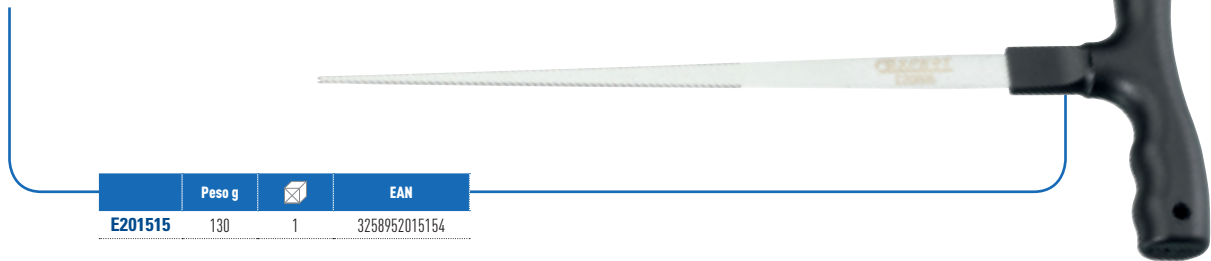

E201515	Peso g		EAN
E201515	130	1	3258952015154

2 PEGAS DE TIRAGEM + ARAME

- Par de pegas de tiragem para corte de junta de pára-brisas.
- Corda de piano incluída.



E201516	Peso g		EAN
E201516	360	1	3258952015161

CORDA DE PIANO QUADRADA

- Corda de piano inoxidável.
- Utilizável com as pegas de tiragem E201516.
- Secção quadrada para um corte eficiente e rápido.
- 5 m.

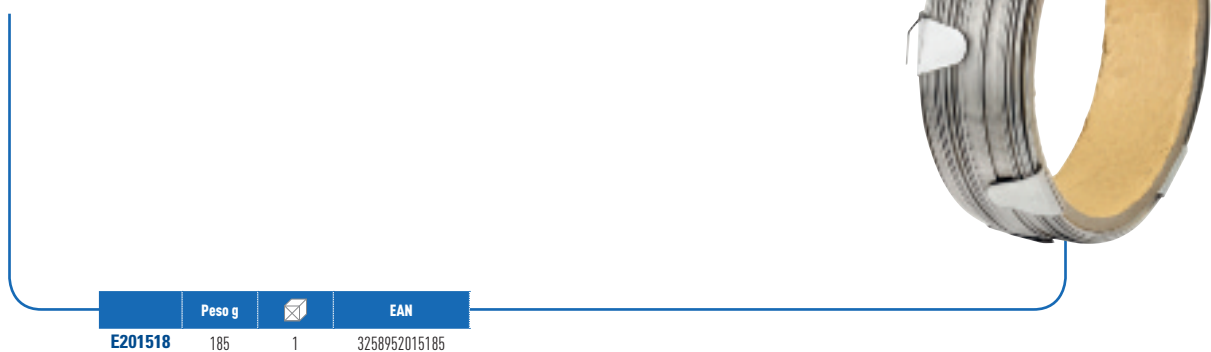

E201518	Peso g		EAN
E201518	185	1	3258952015185





PÁRA-BRISAS

PROTEÇÃO DE PAINEL DE INSTRUMENTOS

- Permite não danificar o painel de instrumentos aquando do corte da junta de pára-brisas com a corda de piano.
- Formas planas ou arredondadas para se adaptar a todos os tipos de cortes.



	Peso g		EAN
E201522	306	1	3258952015222

X-ACTO DE PÁRA-BRISAS PARA CORTE A FRIO

- Ferramenta de corte a frio para junta de pára-brisas.
- Lâmina de 90° substituível.
- Pega principal para inserir e orientar a lâmina.
- Pega de tiragem para aplicar uma força de corte.

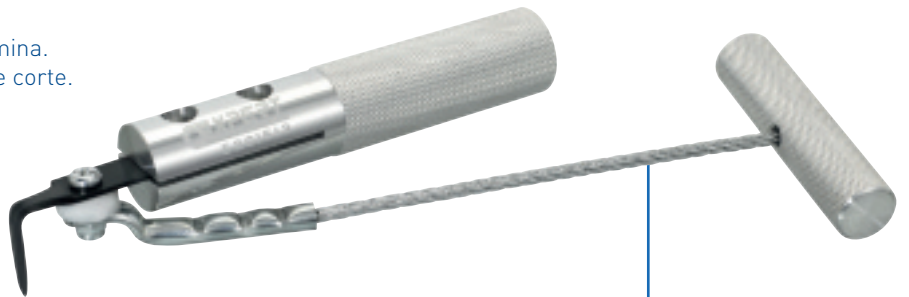

	Peso g		EAN
E201513	274	1	3258952015130

LÂMINAS DE X-ACTO

- 6 lâminas sobresselentes para x-acto E201513.



	Peso g		EAN
E201514	85	1	3258952015147



PISTOLA SILICONE

- Ideal para cartuchos de cola pára-brisa ou Berlingots.
- Tubo de alumínio.
- Alça ergonômica.



	Peso g		EAN
E090703	875	1	3258950907031

MINI RASCADOR

- Lâmina retrátil.
- Substituição rápida das lâminas
- Fornecido com 3 lâminas.
- Possibilidade de armazenar 2 lâminas no compartimento traseiro.



	Peso g		EAN
E201209	6	1	3258951001141

RASCADOR

- Pega plástica.
- Porta-lâminas em metal.
- Lâminas substituíveis.
- Utilizado para retirar os resíduos de cola e etiquetas no pára-brisas.
- 1 lâmina fornecida.



	Peso g		EAN
E201519	310	1	3258952015192

LÂMINAS SOBRESSELENTES PARA RASCADOR

- Para rascador E201520
- Em caixa de 5 lâminas.



	Peso g		EAN
E201520	12	1	3258952015208





**ESTIMULE O SEU PONTO DE VENDA COM AS
SOLUÇÕES DE MERCHANDISING DA EXPERT**

1 MODULO

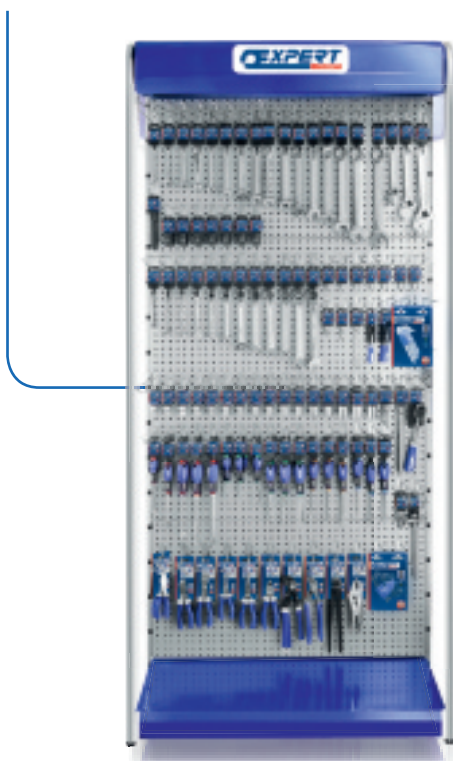

2 MODULO



3 MODULO





EXPERT EXPOSITOR 1M (30 GANCHOS INCLUÍDOS)

- 220 x 100 x 48 cm
- Prateleira e lote de 30 passadores incluídos

E900201



PRATELEIRA PARA CHAVES DE FENDA

- 23 filas de perfurações:
- 15 filas centrais para as dimensões mais correntes
 - 5 filas nas extremidades para as lâminas mais grossas
 - 3 filas dedicadas às lâminas finas

E900203



PRATELEIRA INCLINADA

- Para as caixas
- Prateleira inclinada, com rebordos, para apresentar as caixas de jogos abertas ou fechadas

E900204



10 SEPARAÇÕES PARA PRATELEIRA INCLINADA

- Para as chaves de caixa
- Jogo de 10 separações, a adicionar à prateleira inclinada, para apresentar as chaves de caixa e acessórios

E900205





EXPOSITORES PARA ARMÁRIO

Entrega dos produtos num expositor, para todas as encomendas que tenham a unidade de acondicionamento.

MINI-RASCADOR E201209

- Unidade de acondicionamento: 12
- Encontre este produto na página 265.



ESPELHO TELESCÓPICO COM LEDS E051401

- Unidade de acondicionamento: 12
- Encontre este produto na pag. 201.



LANTERNA RECARREGÁVEL USB E201406

- Unidade de acondicionamento: 12
- Encontre este produto na página 201.





SINALETICA DA MARCA

ORIFLAMES

- Sistema de fixação: base e argolas rotativas
- Entregue num saco de transporte.
- E900308: dimensões: 2,15 x 0,65 m.
- E900301: dimensões: 3,40 x 0,65 m.



PAINEL E900309

- Painel em poliéster 110 g/m² com 4 ilhós.
- Dimensões: 1,80 x 1,20 m.



BANDEIROLA EXTERIOR E900310

- Bandeira em vinil 440 g com ilhós e cordas elásticas.
- Dimensões: 2 x 0,6 m.



AUTOCOLANTES 2 CORES (PACK DE 25)

- Autocolantes EXPERT logo em branco:
 - E900306: 225 x 60 mm.
 - E900304: 155 x 40 mm.
 - E900302: 75 x 20 mm.
- Autocolantes EXPERT logo em azul:
 - E900307: 255 x 60 mm.
 - E900305: 155 x 40 mm.
 - E900303: 75 x 20 mm.





UMA SELEÇÃO DE FERRAMENTAS EXPERT ESTÁ DISPONÍVEL EM BLISTER COMO COMPLEMENTO DA OFERTA STANDARD

CHAVE

Referência	Designação	EAN	Unidades
E113202R	CHAVE MISTA - 6 MM	3258955132025	5
E113200R	CHAVE MISTA - 7 MM	3258955132001	5
E113201R	CHAVE MISTA - 8 MM	3258955132018	5
E113204R	CHAVE MISTA - 9 MM	3258955132049	5
E113205R	CHAVE MISTA - 10 MM	3258955132056	5
E113206R	CHAVE MISTA - 11 MM	3258955132063	5
E113207R	CHAVE MISTA - 12 MM	3258955132070	5
E113208R	CHAVE MISTA - 13 MM	3258955132087	5
E113209R	CHAVE MISTA - 14 MM	3258955132094	5
E113210R	CHAVE MISTA - 15 MM	3258955132100	5
E113211R	CHAVE MISTA - 16 MM	3258955132117	5
E113212R	CHAVE MISTA - 17 MM	3258955132124	5
E113213R	CHAVE MISTA - 18 MM	3258955132131	5
E113214R	CHAVE MISTA - 19 MM	3258955132148	5
E113215R	CHAVE MISTA - 20 MM	3258955132155	5
E113216R	CHAVE MISTA - 21 MM	3258955132162	5
E113217R	CHAVE MISTA - 22 MM	3258955132179	5
E113218R	CHAVE MISTA - 23 MM	3258955132186	5
E113219R	CHAVE MISTA - 24 MM	3258955132193	5
E113222R	CHAVE MISTA - 27 MM	3258955132223	5
E113225R	CHAVE MISTA - 30 MM	3258955132254	5
E113226R	CHAVE MISTA - 32 MM	3258955132261	5
E117391R	CHAVE PARA TUBOS - 11X13 MM	3258955173912	5
E117392R	CHAVE PARA TUBOS - 12X14 MM	3258955173929	5
E117378R	CHAVE MISTA DE ROQUETE - 7 MM	3258955173783	5
E113301R	CHAVE MISTA DE ROQUETE - 8 MM	3258955133015	5
E113302R	CHAVE MISTA DE ROQUETE - 9 MM	3258955133022	5
E113303R	CHAVE MISTA DE ROQUETE - 10 MM	3258955133039	5
E113300R	CHAVE MISTA DE ROQUETE - 11 MM	3258955133008	5
E113304R	CHAVE MISTA DE ROQUETE - 12 MM	3258955133046	5
E113305R	CHAVE MISTA DE ROQUETE - 13 MM	3258955133053	5
E113306R	CHAVE MISTA DE ROQUETE - 14 MM	3258955133060	5
E113307R	CHAVE MISTA DE ROQUETE - 15 MM	3258955133077	5
E113308R	CHAVE MISTA DE ROQUETE - 16 MM	3258955133084	5
E113309R	CHAVE MISTA DE ROQUETE - 17 MM	3258955133091	5
E113310R	CHAVE MISTA DE ROQUETE - 18 MM	3258955133107	5
E113311R	CHAVE MISTA DE ROQUETE - 19 MM	3258955133114	5
E117370R	CHAVE MISTA DE ROQUETE - 21 MM	3258955173707	5
E117371R	CHAVE MISTA DE ROQUETE - 22 MM	3258955173714	5
E117372R	CHAVE MISTA DE ROQUETE - 24 MM	3258955173721	5



LEMBRETE

Jogos de chaves disponíveis em expositor plástico ou em caixa de cartão promocional.
Jogos de chaves de caixa 1/4» à 1/2» disponíveis em blister.



Referência	Designação	EAN	Unidades
E113370R	CHAVES DE CACHIMBO 12X6 FACES - 8 MM	3258955133701	5
E113371R	CHAVES DE CACHIMBO 12X6 FACES - 9 MM	3258955133718	5
E113372R	CHAVES DE CACHIMBO 12X6 FACES - 10 MM	3258955133725	5
E113373R	CHAVES DE CACHIMBO 12X6 FACES - 11 MM	3258955133732	5
E113374R	CHAVES DE CACHIMBO 12X6 FACES - 12 MM	3258955133749	5
E113375R	CHAVES DE CACHIMBO 12X6 FACES - 13 MM	3258955133756	5
E113376R	CHAVES DE CACHIMBO 12X6 FACES - 14 MM	3258955133763	5
E113377R	CHAVES DE CACHIMBO 12X6 FACES - 15 MM	3258955133770	5
E113378R	CHAVES DE CACHIMBO 12X6 FACES - 16 MM	3258955133787	5
E113379R	CHAVES DE CACHIMBO 12X6 FACES - 17 MM	3258955133794	5
E113380R	CHAVES DE CACHIMBO 12X6 FACES - 18 MM	3258955133800	5
E113381R	CHAVES DE CACHIMBO 12X6 FACES - 19 MM	3258955133817	5
E113383R	CHAVES DE CACHIMBO 12X6 FACES - 21 MM	3258955133831	5
E113384R	CHAVES DE CACHIMBO 12X6 FACES - 22 MM	3258955133848	5
E113386R	CHAVES DE CACHIMBO 12X6 FACES - 24 MM	3258955133862	5
E113389R	CHAVES DE CACHIMBO 12X6 FACES - 30 MM	3258955133893	5
E113390R	CHAVES DE CACHIMBO 12X6 FACES - 32 MM	3258955133909	5
E187366R	CHAVE CRESCENTE 150 MM	3258955873669	5
E187368R	CHAVE CRESCENTE 200 MM	3258955873683	5
E187470R	CHAVE CRESCENTE 250 MM	3258955874703	5
E187472R	CHAVE CRESCENTE 300 MM	3258955874727	5
E187473R	CHAVE CRESCENTE 375 MM	3258955874734	5



CHAVES E ACESSÓRIOS

Referência	Designação	EAN	Unidades
E030601R	ROQUETE CABEÇA REDONDA 1/4	3258955306013	5
E030602R	ROQUETE CABEÇA ARTICULADA 1/4	3258955306020	5
E030605R	ROQUETE PARQUIMETRO 1/4 COM BLOQUEIO	3258955306051	5
E113771R	EXTENSÃO 1/4" 55 MM	3258955137716	5
E117356R	EXTENSÃO 1/4" 100 MM	3258955173561	5
E113772R	EXTENSÃO 1/4" 150 MM	3258955137723	5
E117360R	CARDAN 1/4"	3258955173608	5
E113910R	PUNHO 1/4"	3258955139109	5
E117294R	CHAVE CAIXA 1/4" 6 FACES 5MM	3258955172946	5
E117296R	CHAVE CAIXA 1/4" 6 FACES 6MM	3258955172960	5
E117297R	CHAVE CAIXA 1/4" 6 FACES 7MM	3258955172977	5
E117298R	CHAVE CAIXA 1/4" 6 FACES 8MM	3258955172984	5
E117299R	CHAVE CAIXA 1/4" 6 FACES 9MM	3258955172991	5
E117350R	CHAVE CAIXA 1/4" 6 FACES 10MM	3258955173509	5
E117351R	CHAVE CAIXA 1/4" 6 FACES 11MM	3258955173516	5
E117352R	CHAVE CAIXA 1/4" 6 FACES 12MM	3258955173523	5
E117353R	CHAVE CAIXA 1/4" 6 FACES 13MM	3258955173530	5
E117354R	CHAVE CAIXA 1/4" 6 FACES 14MM	3258955173547	5
E113755R	CHAVE CAIXA 1/4" LONGA 6 FACES 7MM	3258955137556	5
E113756R	CHAVE CAIXA 1/4" LONGA 6 FACES 8MM	3258955137563	5
E113757R	CHAVE CAIXA 1/4" LONGA 6 FACES 9MM	3258955137570	5
E113758R	CHAVE CAIXA 1/4" LONGA 6 FACES 10MM	3258955137587	5
E113759R	CHAVE CAIXA 1/4" LONGA 6 FACES 11MM	3258955137594	5
E113760R	CHAVE CAIXA 1/4" LONGA 6 FACES 12MM	3258955137600	5
E113761R	CHAVE CAIXA 1/4" LONGA 6 FACES 13MM	3258955137617	5
E113762R	CHAVE CAIXA 1/4" LONGA 6 FACES 14MM	3258955137624	5





CHAVES E ACESSÓRIOS

Referência	Designação	EAN	Unidades
E031702R	ROQUETE CABO ARTICULADO 3/8"	3258955317026	5
E031706R	ROQUETE PARQUIMETRO 3/8"	3258955317064	5
E113850R	EXTENSÃO 3/8" 125 MM	3258955138508	5
E117367R	CARDAN 3/8"	3258955173677	5
E030939R	CHAVE CAIXA 3/8" 6 FACES - 10 MM	3258955309397	5
E030940R	CHAVE CAIXA 3/8" 6 FACES - 11 MM	3258955309403	5
E030941R	CHAVE CAIXA 3/8" 6 FACES - 12 MM	3258955309410	5
E030942R	CHAVE CAIXA 3/8" 6 FACES - 13 MM	3258955309427	5
E030943R	CHAVE CAIXA 3/8" 6 FACES - 14 MM	3258955309434	5
E030944R	CHAVE CAIXA 3/8" 6 FACES - 15 MM	3258955309441	5
E030945R	CHAVE CAIXA 3/8" 6 FACES - 16 MM	3258955309458	5
E030946R	CHAVE CAIXA 3/8" 6 FACES - 17 MM	3258955309465	5
E030947R	CHAVE CAIXA 3/8" 6 FACES - 18 MM	3258955309472	5
E030948R	CHAVE CAIXA 3/8" 6 FACES - 19 MM	3258955309489	5
E032801R	ROQUETE CABEÇA REDONDA 1/2"	3258955328015	5
E032802R	ROQUETE CABEÇA ARTICULADA 1/2"	3258955328022	5
E032803R	ROQUETE CABO ARTICULADO 1/2"	3258955328039	5
E032805R	CABO 1/2" ARTICULADO 600 MM	3258955328053	5
E032808R	ROQUETE PARQUIMETRO 1/2"	3258955328084	5
E117259R	PUNHO EM T 1/2"	3258955172595	5
E113710R	EXTENSÃO 1/2" 75 MM	3258955137105	5
E117260R	EXTENSÃO 1/2" 130 MM	3258955172601	5
E117261R	EXTENSÃO 1/2" 250 MM	3258955172618	5
E117264R	CARDAN 1/2"	3258955172649	5
E117086R	CHAVE CAIXA 1/2" 6 FACES 8 MM	3258955170867	5
E117088R	CHAVE CAIXA 1/2" 6 FACES 10 MM	3258955170881	5
E117089R	CHAVE CAIXA 1/2" 6 FACES 11 MM	3258955170898	5
E117090R	CHAVE CAIXA 1/2" 6 FACES 12 MM	3258955170904	5
E117091R	CHAVE CAIXA 1/2" 6 FACES 13 MM	3258955170911	5
E117092R	CHAVE CAIXA 1/2" 6 FACES 14 MM	3258955170928	5
E117093R	CHAVE CAIXA 1/2" 6 FACES 15 MM	3258955170935	5
E117094R	CHAVE CAIXA 1/2" 6 FACES 16 MM	3258955170942	5
E117095R	CHAVE CAIXA 1/2" 6 FACES 17 MM	3258955170959	5
E117096R	CHAVE CAIXA 1/2" 6 FACES 18 MM	3258955170966	5
E117097R	CHAVE CAIXA 1/2" 6 FACES 19 MM	3258955170973	5
E117098R	CHAVE CAIXA 1/2" 6 FACES 20 MM	3258955170980	5
E117099R	CHAVE CAIXA 1/2" 6 FACES 21 MM	3258955170997	5
E117250R	CHAVE CAIXA 1/2" 6 FACES 22 MM	3258955172502	5
E117251R	CHAVE CAIXA 1/2" 6 FACES 23 MM	3258955172519	5
E117252R	CHAVE CAIXA 1/2" 6 FACES 24 MM	3258955172526	5
E117253R	CHAVE CAIXA 1/2" 6 FACES 26 MM	3258955172533	5
E117254R	CHAVE CAIXA 1/2" 6 FACES 27 MM	3258955172540	5
E117255R	CHAVE CAIXA 1/2" 6 FACES 28 MM	3258955172557	5
E117256R	CHAVE CAIXA 1/2" 6 FACES 29 MM	3258955172564	5
E117257R	CHAVE CAIXA 1/2" 6 FACES 30 MM	3258955172571	5
E117258R	CHAVE CAIXA 1/2" 6 FACES 32 MM	3258955172588	5
E117265R	CHAVE CAIXA 1/2" 6 FACES LONGA 12 MM	3258955172656	5
E117266R	CHAVE CAIXA 1/2" 6 FACES LONGA 13 MM	3258955172663	5
E117267R	CHAVE CAIXA 1/2" 6 FACES LONGA 14 MM	3258955172670	5
E117268R	CHAVE CAIXA 1/2" 6 FACES LONGA 15 MM	3258955172687	5
E117269R	CHAVE CAIXA 1/2" 6 FACES LONGA 16 MM	3258955172694	5
E117270R	CHAVE CAIXA 1/2" 6 FACES LONGA 17 MM	3258955172700	5
E117271R	CHAVE CAIXA 1/2" 6 FACES LONGA 18 MM	3258955172717	5
E117272R	CHAVE CAIXA 1/2" 6 FACES LONGA 19 MM	3258955172724	5





CHAVES DE PARAFUSOS

Referência	Designação	EAN	Unidades
E113976R	JOGO 9 CH. SEXT. INT. CAB. ESFERICA	3258955139765	5
E121102R	JOGO DE 7 CHAVES TORX	3258955211027	5
E164983R	CHAVE DE FENDAS DE ELETRICISTA 3,5X75	3258955649837	5
E165017R	CHAVE DE FENDAS DE ELETRICISTA 4X100	3258955650178	5
E165476R	CHAVE DE FENDAS DE ELETRICISTA 5,5X125	3258955654763	5
E165141R	CHAVE DE FENDAS DE MECANICO 6,5X150	3258955651410	5
E165138R	CHAVE DE FENDAS DE MECANICO 8X175	3258955651380	5
E160202R	CHAVE DE FENDAS DE MECANICO 6,5X150 SEXT.	3258955602023	5
E160203R	CHAVE DE FENDAS DE MECANICO 8X175 SEXT.	3258955602030	5
E160204R	CHAVE DE FENDAS DE MECANICO 6,5X150 SEXT.	3258955602047	5
E160505R	CHAVE TORX 10X75	3258955605055	5
E160506R	CHAVE TORX 15X75	3258955605062	5
E160507R	CHAVE TORX 20X100	3258955605079	5
E160508R	CHAVE TORX 25X100	3258955605086	5
E160509R	CHAVE TORX 27X100	3258955605093	5
E160510R	CHAVE TORX 30X125	3258955605109	5
E160511R	CHAVE TORX 40X125	3258955605116	5
E165207R	CHAVE PHILIPS 1X100	3258955652073	5
E165209R	CHAVE PHILIPS 2X125	3258955652097	5
E160301R	CHAVE PHILIPS 2X125 SEXT.	3258955603013	5
E165335R	CHAVE POZIDRIVE 1X100	3258955653353	5
E165337R	CHAVE POZIDRIVE 2X125	3258955653377	5
E160401R	CHAVE POZIDRIVE 2X125 SEXT.	3258955604010	5



LEMBRETE

Todos os jogos de chaves de fenda são fornecidos em blister ou em caixa de cartão promocional.

As chaves de roquete são fornecidas em blister.

50 referências de pontas, por lote, em caixa plástica transparente.





CHAVE CAIXA IMPACTO

Referência	Designação	EAN	Unidades
E113494R	CHAVE CAIXA IMPACTO 1/2" 6 FACES 14 MM	3258955134944	5
E113495R	CHAVE CAIXA IMPACTO 1/2" 6 FACES 15 MM	3258955134951	5
E113496R	CHAVE CAIXA IMPACTO 1/2" 6 FACES 16 MM	3258955134968	5
E113497R	CHAVE CAIXA IMPACTO 1/2" 6 FACES 17 MM	3258955134975	5
E113498R	CHAVE CAIXA IMPACTO 1/2" 6 FACES 18 MM	3258955134982	5
E113499R	CHAVE CAIXA IMPACTO 1/2" 6 FACES 19 MM	3258955134999	5
E113588R	CHAVE CAIXA IMPACTO 1/2" 6 FACES 21 MM	3258955135880	5
E113589R	CHAVE CAIXA IMPACTO 1/2" 6 FACES 22 MM	3258955135897	5
E113592R	CHAVE CAIXA IMPACTO 1/2" 6 FACES 24 MM	3258955135927	5
E113594R	CHAVE CAIXA IMPACTO 1/2" 6 FACES 27 MM	3258955135941	5
E113596R	CHAVE CAIXA IMPACTO 1/2" 6 FACES 30 MM	3258955135965	5
E113617R	EXTENSAO IMPACTO 1/2" 125 MM	3258955136177	5



ALICATES

Referência	Designação	EAN	Unidades
E080205R	ALICATE CORTE DIAGONAL MECANICO 160 MM	3258955802058	5
E080206R	ALICATE CORTE DIAGONAL MECANICO 180 MM	3258955802065	5
E080209R	ALICATE CORTE DIAGONAL ELETRICISTA 160 MM	3258955802096	5
E080407R	ALICATE PONTAS SEMI-REDONDAS 160 MM	3258955804076	5
E080408R	ALICATE PONTAS SEMI-REDONDAS 200 MM	3258955804083	5
E080409R	ALICATE DE PONTAS CURVAS 160 MM	3258955804090	5
E080410R	ALICATE DE PONTAS CURVAS 200 MM	3258955804106	5
E080503R	ALICATE UNIVERSAL 160MM	3258955805035	5
E080504R	ALICATE UNIVERSAL 180MM	3258955805042	5
E050106R	ALICATE PARA DESCARNAR 170MM	3258955501067	5
E050415R	ALICATES EXTENSIVEIS 1000 VOLTIOS 250MM	3258955504150	5
E184690R	ALICATE EXTENSIVO COM PUNHO PVC 240 MM	3258955846908	5
E084648R	ALICATES EXTENSIVEIS 250 MM	3258955846489	5
E050406R	ALICATE CORTE DIAGONAL 1000 VOLTIOS 160MM	3258955504068	5
E050408R	ALICATE PONTAS SEMI-REDONDAS 1000 VOLTIOS 160MM	3258955504082	5
E050410R	ALICATE DE PONTAS CURVAS 1000 VOLTIOS 160MM	3258955804105	5
E050412R	ALICATE UNIVERSAL 1000 VOLTIOS 160MM	3258955504129	5
E050413R	ALICATE UNIVERSAL 1000 VOLTIOS 180MM	3258955504136	5
E050416R	ALICATE PARA DESCARNAR 1000 VOLTIOS 170MM	3258955504167	5
E084808R	ALICATE PONTAS CURTAS 185 MM / 7 1/2"	3258955848087	5
E080701R	ALICATE DE PRESSÃO GRANDE CAPACIDADE 250MM	3258955807015	5
E084648R	ALICATES AJÚSTAVEIS 250 MM	3258955846489	5
E084808R	ALICATES DE PRESSÃO MONO-REGULÁVEIS MORDENTES CURTOS	3258955848087	5
E117903R	ALICATE APRA CRAVAR	3258955179037	5
E184182R	TURQUEZ 280 MM	3258955841828	5



LEMBRETE

Todos os jogos de alicates são fornecidos em cartão.



MARTELOS

Referência	Designação	EAN	Unidades
E150102R	MARTELO DIN DE 30MM	3258955501029	5
E150103R	MARTELO DIN DE 50MM	3258955501036	5
E150104R	MARTELO DIN DE 80MM	3258955501043	5
E154668R	MARTELO DE PENA 32MM	3258955546686	5
E154670R	MARTELO DE PENA 40MM	3258955546709	5
E154674R	MARTELO DE PENA 55MM	3258955546747	5
E150302R	MARTELO COM BATENTES DE 32 MM	3258955503023	5



OUTRAS

Referência	Designação	EAN	Unidades
E020902R	TESOURA TIPO AVIAÇÃO CORTE Á DIREITA	3258955209024	5
E020903R	TESOURA TIPO AVIAÇÃO CORTE Á ESQUERDA	3258955209031	5
E117821R	CHAVE CORTA TUBOS DE 10"	3258955178214	5
E117822R	CHAVE CORTA TUBOS DE 14"	3258955178221	5



LEMBRETE

As embalagens de vários produtos do catálogo destinam-se naturalmente a uma apresentação nos pontos de venda.

Alguns exemplos:

- As caixas de chaves de caixa e de pontas em protector.
- A maioria dos produtos automóvel em caixa, em cartão ou em blister.
- A gambiarra e o alicate para cravar em blister...

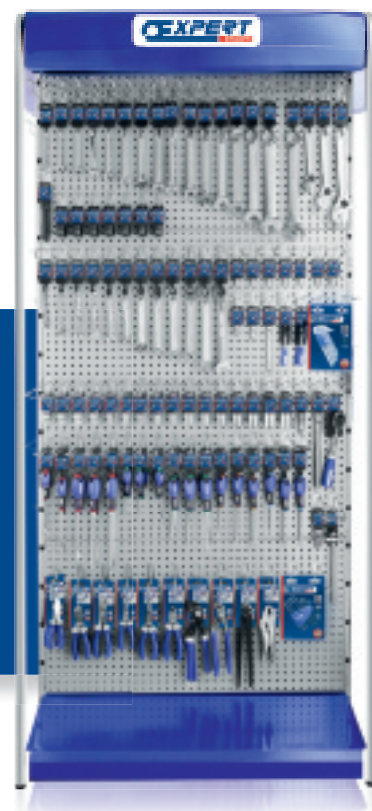

PARAFUSOS SEXTAVADOS

Chaves de aperto de abertura fixa 	PARAFUSOS MÉTRICOS (Ø dos parafusos em mm)		PORCAS MÉTRICAS (Ø dos parafusos em mm)	
	NF EN ISO 4018	NF EN ISO 4014	NF EN ISO 4035	NF EN ISO 4032
3,2		1,6	1,6	1,6
4		2	2	2
4,5		2,3	2,2+2,3	2,2+2,3
5		2,5+2,6	2,5+2,6	2,5+2,6
5,5		3	3	3
6		3,5	3,5	
7		4	4	4
8	5	5	5	5
9				
10	6	6	6	6
11	7	7	7	7
12				
13	8	8	8	8
14				
15				
16	(10)	(10)	(10)	
17	10	10	10	10
18	(12)	(12)	(12)	(12)
19	12	12	12	12
20				
21	(14)	(14)	(14)	(14)
22	14	14	14	14
23				
24	16	16	16	16
25				
26				
27	18	18	18	18
28				
29				
30	20	20	20	20
32	22	22	22	22

(): ISO 691

PARAFUSOS DE FENDA



DE ACORDO COM AS NORMAS : NF - E74352 / ISO 2380 - 1 / DIN 5263

A x B	PARAFUSOS MÉTRICOS (Ø dos parafusos em mm)					PARAFUSOS PARA CHAPA (Ø dos parafusos em mm)			PARAFUSOS PARA MADEIRA (Ø dos parafusos em mm)		
	Cabeça fresada	Fresada abaulada	Cilíndrica	Cilíndrica grande	Sem cabeça	Cabeça fresada	Fresada abaulada	Cilíndrica	Cabeça fresada	Cabeça abaulada	Cabeça redonda
	NF EN ISO 2009	NF EN ISO 2010	NF EN ISO 1207	NF EN ISO 1580	NF EN 24766	NF EN ISO 1482	NF EN ISO 1483	NF E 1481	NF E 25-604	NF E 25-605	NF E 25-606
0,4 x 2	1,6				2,5+3				1,6		1,6
0,4 x 2,5		1,6	1,6+1,8	1,6	3,5					1,6	2
*0,5 x 3	2	2	2	2	4	2,2	2,2	2,2	2,2	2	
0,6 x 4			2				2,2				
0,6 x 3,5	2,5	2,5	2,5	2,5				2,2	2,5	2,5	2,5
*0,6 x 4,5		2,5	2,5				2,2			2,5	
0,8 x 4	3	3	3	3+3,5	5	2,9	2,9	2,9	3	3	3
*0,8 x 5,5	3,5	3,5	3	3+3,5							3,5
1 x 5,5	3,5+4	3,5+4	3,5	4		3,5/3,9	3,5/3,9	3,5+3,9	4+4,5	4+4,5	4+4,5
1,2 x 6,5	4+5	4+5	4		8	4,2+4,8	4,2+4,8		5	5	5+5,5
1,2 x 8		5	5			4,8	4,2+4,8	5,5	5,5		
1,6 x 8	6	6			10+12	5,5+6,3	5,5+6,3		6	6	6
1,6 x 10		6	6	14		6,3	5,5+6,3	7+8	7		
2 x 12	8	8	8	8	16	8	8	8		8	7+8

* Apenas para aparafusadoras

PERFIS PHILLIPS® - POZIDRIV®



PH	PZ	PARAFUSOS MÉTRICOS (Ø dos parafusos em mm)		PARAFUSOS PARA CHAPA (Ø dos parafusos em mm)			PARAFUSOS PARA MADEIRA (Ø dos parafusos em mm)		
		Fresada e fresada abaulada	Cilíndrica	Cilíndrica	Cabeça fresada	Fresada abaulada	Fresada abaulada	Redonda	Cabeça fresada
		NF EN ISO 7044-1 NF EN ISO 7046-2 NF EN ISO 7047	NF EN ISO 7045	NF EN ISO 7049	NF EN ISO 7050	NF EN ISO 7051	NF E 25-602	NF E 25-603	NF E 25-601
*00									
0	0	1,6	1,6	(2,2)	(2,2)	(2,2)	2	2	2
		2	1,8						
1	1	2,5	2	2,2	2,2	2,2	2,5	2,5	2,5
		3	2,5+3	2,9	2,9	2,5+2,9	3	3	3
		3,5	3,5	3,5	3,5	3,5	3,5	3,5	3,5
2	2	4	4	4,2	4,2	4,2	4+4,5	4+4,5	4+4,5
		5	5	4,8	4,8	4,8	5	5	5
							5,5	5,5	5,5
3	3	6	6	5,5	5,5	5,5	6	6	6
				6,3	6,3	6,3	7	7	7
4	4	8	8	8	8	8	8	8	8
		10	10	9,5	9,5	9,5			

*PARAFUSOS ESPECIAL

PERFIS TORX®



		PARAFUSOS MÉTRICOS (Ø dos parafusos em mm)				PARAFUSOS PARA CHAPA (Ø dos parafusos em mm)		
		Cilíndrica	Fresada	Fresada abaulada	Cilíndrica abaulada	Cilíndrica	Fresada	Fresada abaulada
		NF EN ISO 14583	NF E 25-107	NF EN ISO 14584	NF EN ISO 14579	NF EN ISO 14585	NF EN ISO 14586	NF EN ISO 14587
T6	1,65	X	X	X	X	X	X	X
T7	1,97	X	X	X	X	X	X	X
T8	2,30	2,5	2,5	2,5	2,5	2,9	2,9	2,9
T9	2,48					2,9		
T10	2,72	3	3	3	3	3,5	3,5	3,5
T15	3,26		3,5	3,5	3,5	3,9	3,9	3,9
T20	3,84	4	4	4	4	4,2	4,2	4,2
T25	4,40	5	5	5	5	4,8+5,5	4,8+5,5	4,8+5,5
T27	4,96	XX	XX	XX	XX	XX	XX	XX
T30	5,49	6	6	6	6	6,3	6,3	6,3
T40	6,60	8	8	8	8			
T45	7,77	XXX	XXX	XXX	XXX	XXX	XXX	XXX
T50	8,79	10	10	10	10			

PARAFUSOS ESPECIAL : X : 1,6 - 2 XX : 4,5 - 5 - 6 XXX : 8 - 10

CHAVES MACHO - PARAFUSOS SEXTAVADOS OCOS



		Parafuso métrico (Ø dos parafusos em mm)				
		Cilíndrica	Cabeça fresada	Sem cabeça	Sem cabeça ponteiro	Sem cabeça saliente
		NF EN ISO 4762	NF EN ISO 10642	NF EN ISO 4026 / NF EN ISO 4029	NF EN ISO 4027	NF EN ISO 4028
0,9				2	2	2
1,3	1,4			2,5	2,5	2,5
1,5	1,6+2			3	3	3
2	2,5	3		4	4	4
2,5	3	4		5	5	5
3	4	5		6	6	6
4	5	6		8	8	8
5	6	8		10	10	10
6	8	10		12+14	12+14	12+14
7						
8	10	12		16	16	16
10	12	14+16		18+20	18+20	18+20
12	14	18+20		22+24	22+24	22+24
14	16+18	22+24				
17	20+22					
19	24+27					
22	30					
24	33					

A

1 MODULO	264
1 PACK DE 5 CAVILHAS METÁLICAS E 5 ANÉIS PARA CHAVES DE CAIXA DE IMPACTO 1/2"	151
1 PACK DE 5 CAVILHAS METÁLICAS E 5 ANÉIS PARA CHAVES DE CAIXA DE IMPACTO 3/4"	154
1/2" MÉTRICAS - 44 PEÇAS	53
10 SEPARAÇÕES PARA PRATELEIRA INCLINADA	265
2 MODULO	264
2 PEGAS DE TIRAGEM + ARAME	261
20 PEÇAS	67
3 MODULO	264
4 PEÇAS	156
ACESSÓRIOS	197
ADAPTADOR MAGNÉTICO 1/2" - 3/4"	88
ADAPTADOR MAGNÉTICO 1/4" - 3/8"	60
ADAPTADOR MAGNÉTICO 3/8" - 1/2"	71
AGULHA DE INTRODUÇÃO	261
ALAVANCAS DE ESFORÇO	205
ALAVANCAS DE ESFORÇO	230
ALAVANCAS DESMONTA-PNEUS	251
ALICATE AUTOMÁTICO PARA DESCARNAR	215
ALICATE CURVO PARA CLIPS	255
ALICATE DE CORTE DIAGONAL OBLÍQUO	164
ALICATE DE CORTE FRONTAL - 160 MM	163
ALICATE DE CORTE PARA ELETRICIDADE	163
ALICATE DE CORTE PARA ENGENHARIA	163
ALICATE DE CORTE PARA ENGENHARIA - ISOLADO 1000 V - VDE	216
ALICATE DE CORTE RASO FINO	225
ALICATE DE DESCARNAR 170 MM	215
ALICATE DE DESCARNAR 170 MM - 1000 V ISOLADO - VDE	217
ALICATE DE DESMONTAGEM SILENT-BLOCS DE ESCAPE	247
ALICATE DE PONTAS AFILADAS CURVAS	224
ALICATE DE PONTAS AFILADAS DIREITAS	224
ALICATE DE PONTAS CHATAS	224
ALICATE DE PONTAS DIREITAS LONGAS	165
ALICATE DE PONTAS REDONDAS 170 MM	165
ALICATE DE PONTAS SEMI-REDONDAS - ISOLADO 1000 V - VDE	216
ALICATE DE PRESSÃO GRANDE CAPACIDADE	169
ALICATE DESAGRAFADOR	255
ALICATE MULTIGRIP - 1000 V ISOLADO - VDE	216
ALICATE PARA CRAVAR	214
ALICATE PARA CRAVAR	214
ALICATE PARA CRAVAR TERMINAIS NÃO ISOLADOS	214
ALICATE PARA PESOS DE CALIBRAGEM	251
ALICATE PARA REBITAR 270 MM	206
ALICATE PARA TUBOS	209
ALICATE PARA TUBOS	209
ALICATE PARA TUBOS FLEXÍVEIS DE COMBUSTÍVEL	244
ALICATE PLANO - PONTAS RETAS - 160 MM	165
ALICATE SACA-BOCADOS	206
ALICATE UNIVERSAL	162
ALICATE UNIVERSAL - ISOLADO 1000 V - VDE	217
ALICATES	272
ALICATES AJÚSTAVEIS	162
ALICATES AJÚSTAVEIS SOBREPOSTO - 240 MM	162
ALICATES CIRCLIPS® - DE ABRIR, PONTAS DIREITAS	167
ALICATES DE CORTE AXIAIS ROBUSTOS	225
ALICATES DE CORTE DIAGONAL	164
ALICATES DE PRESSÃO LONGO ALCANCE	169
ALICATES DE PRESSÃO MONOREGULÁVEIS MORDENTES CURTOS	168
ALICATES DE PRESSÃO MONO-REGULÁVEIS MORDENTES LONGOS	168
ALICATES PARA ABRAÇADEIRAS DE AUTO-APERTO	243
ALICATES PARA FREIOS CIRCLIPS® - DE FECHAR PONTAS A 90°	167
ALICATES PARA FREIOS CIRCLIPS® - DE ABRIR PONTAS CURVAS A 90°	167

ALICATES PARA FREIOS CIRCLIPS® - DE FECHAR PONTAS

DIREITAS	166
ALMOFADA ABRE-PORTAS INSUFLÁVEL	256
ALMOLOTOLIAS	207
APALPA FOLGAS - ESPESSURAS MÉTRICAS	237
APALPA FOLGAS LONGOS MÉTRICOS	237
APARELHO DE TESTE DA PRESSÃO DE PNEUS	252
APARELHO DE TESTE MULTIFUNÇÕES	242
APARELHO DE TESTE VAT	242
AUMENTADOR 1/2" - 3/4"	88
AUMENTADOR 3/4" - 1"	98
AUMENTO 1/4" - 3/8"	60
AUMENTO 3/8" - 1/2"	72
AUTOCOLANTES 2 CORES (PACK DE 25)	267

B

BANCADA DE MADEIRA	13
BANCADA DE METAL	13
BANCO	256
BANDEIROLA EXTERIOR E900310	267
BATENTES INTERMUTÁVEIS EM NYLON	181
BAÚS DE ESTALEIRO	15
BERBEQUINS REVERSÍVEIS 3/8"	144
BOOSTER 12 V	239
BOTIJA DE ENCHIMENTO DEPÓSITO	248
BRAKE TESTADOR DE FLUIDO	249

C

CABO "T" CORREDIÇA	100
CABO EM T CORREDIÇO 3/8"	70
CABO PARA ROQUETE 3/4"	96
CABO T CORREDIÇO - 1/2"	87
CABO T CORREDIÇO - 1/4"	59
CABO T CORREDIÇO 3/4"	96
CAIXA COM CHAVES DE FENDA MULTI-LÂMINAS DE PRECISÃO	222
EM ALUMÍNIO	236
CAIXA DE APARAFUSAMENTO 1/4" COM CHAVE REVÓLVER - 59 PEÇAS	133
CAIXA DE CHAVES 1/2" DE COROA - 32 PEÇAS	79
CAIXA DE CHAVES DE CAIXA 1/2" - 14 PEÇAS	83
CAIXA DE CHAVES DE CAIXA 1/2" - 25 PEÇAS	83
CAIXA DE CHAVES DE CAIXA 1/2" - 26 PEÇAS	82
CAIXA DE CHAVES DE CAIXA 1/2" - 28 PEÇAS	82
CAIXA DE CHAVES DE CAIXA 1/2" - 36 PEÇAS	82
CAIXA DE CHAVES DE CAIXA 3/4" - 14 PEÇAS	95
CAIXA DE CHAVES DE CAIXA 3/8" DE 12 FACES - MÉTRICAS - 22 PEÇAS	66
CAIXA DE CHAVES DE CAIXA E ACESSÓRIOS - 1/2" MÉTRICAS - 22 PEÇAS	77
CAIXA DE CHAVES DE CAIXA E ACESSÓRIOS - 1/2" MÉTRICAS - 42 PEÇAS	77
CAIXA DE CHAVES DE CAIXA E ACESSÓRIOS - 3/8" MÉTRICAS - 61 PEÇAS	66
CAIXA DE CHAVES DE CAIXA E ACESSÓRIOS 1/2" - 55 PEÇAS	77
CAIXA DE CHAVES DE CAIXA E ACESSÓRIOS 1/4" - 1/2" MÉTRICAS - 44 PEÇAS	53
CAIXA DE CHAVES DE CAIXA E ACESSÓRIOS 1/4" - 19 PEÇAS	55
CAIXA DE CHAVES DE CAIXA E ACESSÓRIOS 1/4" - 34 PEÇAS	55
CAIXA DE CHAVES DE CAIXA E ACESSÓRIOS 1/4" - 42 PEÇAS	54
CAIXA DE CHAVES DE CAIXA E ACESSÓRIOS 1/4" - 73 PEÇAS	54
CAIXA DE CHAVES DE CAIXA LONGAS 3/8" SEXTAVADAS - MÉTRICAS - 15 PEÇAS	66
CAIXA DE CHAVES DE CAIXA SEXTAVADAS 1/2" - 30 PEÇAS	79
CAIXA DE CHAVES DE CAIXA SEXTAVADAS, TORX®, XZN - 38 PEÇAS	52
CAIXA DE CHAVES DE CAIXA TORX® 1/2" - 16 PEÇAS	78

CAIXA DE CHAVES DE CAIXA, CHAVES E

ACESSÓRIOS 1/4" - 1/2" - 101 PEÇAS	50
CAIXA DE CHAVES DE PANCADA - 12 PEÇAS	127
CAIXA DE CHAVES DE PANCADA - 12 PEÇAS	249
CAIXA DE CHAVES TORX® 1/2" - 32 PEÇAS	78
CAIXA DE CHAVES XZN® 1/2" - 26 PEÇAS	79
CAIXA DE FERRAMENTAS EM TECIDO	17
CAIXA DE PONTAS 1/4" - 100 PEÇAS	128
CAIXA DE PONTAS 1/4" - 61 PEÇAS	129
CAIXA DE ROQUETE CHAVES DE CAIXA 1" - 14 PEÇAS	100
CAIXA METÁLICA 5 DIVISÕES 45 E 53,5 CM	16
CAIXA PARA POLIE DE ALTERNADOR - 13 PEÇAS	247
CAIXA PARA POLIE DE ALTERNADOR - 22 PEÇAS	247
CAIXA PLÁSTICA 41 E 49 CM	16
CARACTERÍSTICAS	112
CARDAN - 1/4"	60
CARDAN 1/2"	89
CARDAN 3/4"	98
CARDAN 3/4" PARA BARRA	98
CARDAN 3/8"	72
CARDAN DE IMPACTO - 3/4"	154
CARDAN DE IMPACTO 1/2"	151
CARRINHO DE INSPEÇÃO	229
CARRINHO DE OFICINA EM ALUMÍNIO E PLÁSTICO	14
CARRINHO DE PILHA	228
CARRO 6 GAVETAS - 3 MÓDULOS POR GAVETA	9
CARRO 7 GAVETAS - 3 MÓDULOS POR GAVETA	9
CARRO 7 GAVETAS, COM COMPARTIMENTO - 3 MÓDULOS POR GAVETA	10
CARRO DE OFICINA COM RODAS	15
CARRO GRANDE 8 GAVETAS - 4 MÓDULOS POR GAVETA	8
CARRO GRANDE DE 7 GAVETAS - 4 MÓDULOS POR GAVETA	8
CASQUILHOS FUSÍVEIS	139
CAVALETE DE CARROÇARIA	256
CHAVE	268
CHAVE ABERTA	250
CHAVE ABERTA SEXTAVADA	42
CHAVE BI-MATÉRIA PARA PARAFUSO DE FENDA	114
CHAVE BI-MATÉRIA PARA PARAFUSO DE FENDA ELÉTRICISTA	114
CHAVE BI-MATÉRIA PARA PARAFUSOS PHILLIPS®	115
CHAVE BI-MATÉRIA PARA PARAFUSOS POZIDRIV®	115
CHAVE CAIXA IMPACTO	272
CHAVE COM CORRENTE	210
CHAVE CRESCENTE	43
CHAVE CURTA COTO PARA PARAFUSOS DE FENDA ELÉTRICISTA	109
CHAVE CURTA COTO PARA PARAFUSOS PHILLIPS®	110
CHAVE CURTA COTO PARA PARAFUSOS POZIDRIV®	111
CHAVE DE APERTO ANGULAR COM BARRA	246
CHAVE DE APERTO ANGULAR COM FLEXÍVEL MAGNÉTICO	246
CHAVE DE CAIXA 1/2" PORTA-PONTEIRA 5/16"	88
CHAVE DE CAIXA 1/4" PORTA-BITS 1/4"	60
CHAVE DE CAIXA 3/8" PORTA-PONTEIRAS 1/4"	71
CHAVE DE CAIXA DE IMPACTO 1/2" PORTA-PONTEIRAS 1/2"	151
CHAVE DE CAIXA DE IMPACTO XZN® M18 1/2"	253
CHAVE DE CORRENTE PARA FILTROS DE ÓLEO	235
CHAVE DE IMPACTO 1"	143
CHAVE DE IMPACTO 3/4" - 1400 N.M	143
CHAVE DE IMPACTO BARRA LONGA 1"	144
CHAVE DE PARAFUSOS PORTA-PONTAS 1/4"	132
CHAVE DE PARAFUSOS PORTA-PONTAS DE ROQUETE	134
CHAVE DE PARAFUSOS PORTA-PONTAS PUNHO GIRATÓRIO COM ROQUETE	133
CHAVE DE PARAFUSOS RESISTORX®	109
CHAVE DE PARAFUSOS TORX®	109
CHAVE DE PINOS	45
CHAVE DE PUNHO 1/4"	59
CHAVE PARA "FILTRO" DE AUTO-APERTO UNIVERSAL	236
CHAVE PARA ANDAIMES 19 MM	45
CHAVE PARA BUJÕES	233
CHAVE PARA PARAFUSOS DE FENDA ELÉTRICISTA	108
CHAVE PARA PARAFUSOS DE FENDA MECÂNICO	108

CHAVE PARA PARAFUSOS DE FENDA MECÂNICO COM SEXTAVADO.....	108	CHAVES DE CAIXA LONGAS 3/8" - SEXTAVADAS - MÉTRICAS.....	74	CORTA-CAVILHAS BRAÇOS TUBULARES.....	189
CHAVE PARA PARAFUSOS PHILLIPS®.....	110	CHAVES DE CAIXA LONGAS 3/8" - SEXTAVADAS - POLEGADAS.....	74	CORTA-TUBOS DE COBRE.....	210
CHAVE PARA PARAFUSOS PHILLIPS® COM SEXTAVADO.....	110	CHAVES DE CAIXA LONGAS DE IMPACTO 1/2" MÉTRICAS - SEXTAVADAS.....	152	CORTADOR DE VIDRO.....	206
CHAVE PARA PARAFUSOS POZIDRIV®.....	111	CHAVES DE CAIXA LONGAS DE IMPACTO 1/2" MÉTRICAS - SEXTAVADAS.....	152	D	
CHAVE PARA PARAFUSOS POZIDRIV®.....	111	CHAVES DE CAIXA MAGNÉTICAS PARA PARAFUSOS SEXTAVADOS.....	132	DE ABRIR PONTAS CURVAS A 90°.....	167
CHAVE PORTA-LÂMINAS.....	135	CHAVES DE CAIXA PARA VELAS.....	237	DE FECHAR PONTAS A 90°.....	167
CHAVE PORTA-PORTAS TURN 6.....	134	CHAVES DE CAIXA TORX® 1/2".....	92	DE IMPACTO 3/4" - 11 PEÇAS.....	153
CHAVE REGULÁVEL PARA FILTRO DE ÓLEO.....	235	CHAVES DE CAIXA TORX® 1/4".....	64	DECAPADOR.....	215
CHAVE REGULÁVEL PARA FILTRO DE ÓLEO - VP.....	235	CHAVES DE CAIXA TORX® 3/8".....	75	DEDO MAGNÉTICO FLEXÍVEL.....	231
CHAVE UNIVERSAL COM CINTA.....	210	CHAVES DE CINTA PARA FILTROS.....	210	DESMONTA-INTERIOR DE VÁLVULA DE AR CONDICIONADO + RODA.....	251
CHAVE+G58 BUSCA POLOS.....	220	CHAVES DE CRUZETA PORCAS DAS RODAS.....	252	DIREITAS.....	166
CHAVES "TIPO FÓRMA" PARA FILTROS DE ÓLEO.....	236	CHAVES DE IMPACTO 1/2".....	142	DISPOSITIVO DE TESTE DO LÍQUIDO DOS TRAVÕES.....	248
CHAVES CRESCENTES BI-MATÉRIA.....	44	CHAVES DE IMPACTO 1/2" COMPACTAS.....	142	E	
CHAVES DE BOCAS - MM.....	34	CHAVES DE IMPACTO 3/4" - 1017 N.M.....	143	E900201.....	265
CHAVES DE BOCAS DIN.....	36	CHAVES DE IMPACTOS 1".....	144	E900203.....	265
CHAVES DE CAIXA 1" - SEXTAVADAS - MÉTRICAS.....	101	CHAVES DE LUNETAS - MM.....	37	E900204.....	265
CHAVES DE CAIXA 1/2" - SEXTAVADAS - MÉTRICAS.....	89	CHAVES DE PARAFUSOS.....	271	E900205.....	265
CHAVES DE CAIXA 1/2" MÉTRICAS - SEXTAVADAS.....	90	CHAVES DE PARAFUSOS ISOLADAS 1000 V PARA PARAFUSOS PHILLIPS®.....	219	EM COMPLEMENTO DA SUA GAMA DE CHAVES TRI-MATÉRIA, EXPERT PROPÕE UMA OFERTA ALTERNATIVA AINDA MAIS COMPETITIVA COM O NOME BI-MATÉRIA.....	112
CHAVES DE CAIXA 1/2" PARA PARAFUSOS SEXTAVADOS INTERIORES.....	93	CHAVES DE ROQUETE "4 EM 1" - MM.....	32	ENTREGA DOS PRODUTOS NUM EXPOSITOR, PARA TODAS AS ENCOMENDAS QUE TENHAM A UNIDADE DE ARCONDICIONAMENTO.....	266
CHAVES DE CAIXA 1/2" PARA PARAFUSOS TORX® INTERIORES.....	93	CHAVES DINAMOMÉTRICAS.....	138	ESCOPRO.....	183
CHAVES DE CAIXA 1/2" PARA PARAFUSOS XZN®.....	94	CHAVES E ACESSÓRIOS.....	269	ESCOPRO EXTRA PLANO 26 MM.....	183
CHAVES DE CAIXA 1/2" POLEGADAS - 12 FACES.....	90	CHAVES E ACESSÓRIOS.....	270	ESCOVA METÁLICA.....	238
CHAVES DE CAIXA 1/2" PONTA LONGA PARA PARAFUSOS TORX®.....	94	CHAVES ISOLADAS 1000 V PARA PARAFUSOS DE FENDA.....	219	ESCOVA PARA TRAVÕES.....	249
CHAVES DE CAIXA 1/2" PONTA LONGA PARA PARAFUSOS XZN®.....	94	CHAVES ISOLADAS 1000 V PARA PARAFUSOS PHILLIPS®.....	219	ESPELHO LED TELESCÓPICO.....	231
CHAVES DE CAIXA 1/2" PONTAS LONGAS PARA PARAFUSOS SEXTAVADOS INTERIORES.....	93	CHAVES MACHO EM T COM CABO SEXTAVADAS DE CABEÇA ESFÉRICA MÉTRICA (1).....	124	ESPELHO TELESCÓPICO 2 EM 1.....	231
CHAVES DE CAIXA 1/4" - 12 FACES - MÉTRICAS.....	61	CHAVES MACHO EM T COM CABO SEXTAVADAS MÉTRICAS (1).....	123	ESPELHO TELESCÓPICO COM LEDS E051401.....	266
CHAVES DE CAIXA 1/4" - 12 FACES - POLEGADAS.....	62	CHAVES MACHO EM T COM CABO TORX® (1).....	125	ESPELHO TELESCÓPICO DE LEDS.....	199
CHAVES DE CAIXA 1/4" - SEXTAVADAS - MÉTRICAS.....	61	CHAVES MACHO EM T SEXTAVADAS.....	126	ESPUMA PARA APOIO DE JOELHOS.....	206
CHAVES DE CAIXA 1/4" PARA PARAFUSOS DE FENDA.....	64	CHAVES MACHO RESISTORX®.....	122	ESTETOSCOPIO.....	246
CHAVES DE CAIXA 1/4" PARA PARAFUSOS PHILLIPS®.....	65	CHAVES MACHO SEXTAVADAS CURTAS MÉTRICAS.....	121	ESTOJO DE CHAVES DE CAIXA E ACESSÓRIOS DE IMPACTO 1/2" - 17 PEÇAS.....	148
CHAVES DE CAIXA 1/4" PARA PARAFUSOS POZIDRIV®.....	65	CHAVES MACHO SEXTAVADAS LONGAS EM POLEGADAS.....	120	ESTOJO DE CHAVES DE CAIXA LONGAS DE IMPACTO 1/2" - 14 PEÇAS.....	148
CHAVES DE CAIXA 1/4" PARA PARAFUSOS RESISTORX® INTERIORES.....	65	CHAVES MACHO SEXTAVADAS LONGAS MÉTRICAS.....	118	ESTOJO DE CHAVES DE CAIXA SEXTAVADAS 1/2" - 13 PEÇAS.....	80
CHAVES DE CAIXA 1/4" PARA PARAFUSOS SEXTAVADOS INTERIORES.....	64	CHAVES MACHO TORX®.....	122	EXPERT EXPOSITOR 1M (30 GANCHOS INCLUÍDOS).....	265
CHAVES DE CAIXA 1/4" PARA PARAFUSOS TORX® INTERIORES.....	65	CHAVES MISTAS - MM.....	22	EXPOSITOR DE 10 CHAVES DE CAIXA 1/2" MÉTRICAS.....	78
CHAVES DE CAIXA 3/4" - SEXTAVADAS - MÉTRICAS.....	99	CHAVES MISTAS - POLEGADAS.....	23	EXTENSÃO FLEXÍVEL 1/2" - 200 MM.....	156
CHAVES DE CAIXA 3/4" 12 FACES - POLEGADAS.....	99	CHAVES MISTAS DE ROQUETE - MM.....	28	EXTENSÃO FLEXÍVEL 1/4".....	59
CHAVES DE CAIXA 3/4" SEXTAVADAS - MÉTRICAS.....	95	CHAVES MISTAS DE ROQUETE ARTICULADAS - MM.....	30	EXTENSÃO FLEXÍVEL 3/8" - 200 MM.....	71
CHAVES DE CAIXA 3/8" - SEXTAVADAS - MÉTRICAS.....	73	CHAVES MISTAS DE ROQUETE RÁPIDAS - MM.....	29	EXTENSÕES 1".....	101
CHAVES DE CAIXA 3/8" - SEXTAVADAS - POLEGADAS.....	73	CHAVES MISTAS LONGAS - MM.....	26	EXTENSÕES 1/2".....	87
CHAVES DE CAIXA 3/8" MÉTRICAS - 12 FACES.....	72	CHAVES MISTAS LUNETAS DESVIADA - MM.....	27	EXTENSÕES 1/4".....	59
CHAVES DE CAIXA 3/8" PARA PARAFUSOS TORX® INTERIORES.....	76	CHAVES PARA ANDAIMES.....	45	EXTENSÕES 3/4".....	97
CHAVES DE CAIXA 3/8" PARA PARAFUSOS DE FENDA.....	76	CHAVES PARA ANDAIMES.....	205	EXTENSÕES 3/8".....	70
CHAVES DE CAIXA 3/8" PARA PARAFUSOS PHILLIPS®.....	76	CHAVES PARA ANDAIMES.....	205	EXTENSÕES DE IMPACTO 1/2".....	151
CHAVES DE CAIXA 3/8" PARA PARAFUSOS POZIDRIV®.....	76	CHAVES PARA RODAS DE CAMIÃO.....	252	EXTENSÕES DE IMPACTO 3/4".....	153
CHAVES DE CAIXA 3/8" PARA PARAFUSOS TORX® INTERIORES.....	76	CHAVES PARA TUBOS.....	209	EXTRACTOR 2 GARRAS.....	211
CHAVES DE CAIXA ABERTAS DESCENTRADAS.....	244	CHAVES PARA TUBOS EM ALUMÍNIO.....	208	EXTRACTOR DE ESCOVAS LIMPA-VIDROS.....	260
CHAVES DE CAIXA COM CABO FLEXÍVEIS.....	243	CHAVES PARA TUBOS TIPO SUECA 45°.....	208	EXTRACTOR DE LÍQUIDOS.....	230
CHAVES DE CAIXA COM CABO MÉTRICAS.....	116	CHAVES PARA TUBOS TIPO SUECA 90°.....	208	EXTRACTOR DE TERMINAIS DE BATERIA.....	239
CHAVES DE CAIXA DE IMPACTO 1/2" MÉTRICAS - SEXTAVADAS.....	152	CHAVES POLIGONAIS DE ROQUETE - MM.....	31	EXTRACTOR PARA ESCOVAS LIMPA-VIDROS.....	260
CHAVES DE CAIXA DE IMPACTO 3/4" MÉTRICAS.....	155	CHAVES SEXTAVADAS LONGAS COM CABEÇA ESFÉRICA.....	120	F	
CHAVES DE CAIXA DE IMPACTO LONGAS 1".....	157	CHAVES TIPO CACHIMBO ABERTAS 12 FACES X SEXTAVADAS.....	39	FERRAMENTA DE SANGRAMENTO PARA INJEÇÃO DIESEL.....	244
CHAVES DE CAIXA DE IMPACTO LONGAS 3/4" MÉTRICAS.....	155	CHAVES TUBULARES DIREITAS SEXTAVADAS.....	41	FERRAMENTA REVERSÍVEL DESMONTA-INTERIOR DE VÁLVULA.....	251
CHAVES DE CAIXA HEXAGONAIS DE IMPACTO 1/2".....	153	CHAVES TUBULARES HEXAGONAIS SIMPLES.....	41	FERRAMENTA REVERSÍVEL DESMONTA-INTERIOR DE VÁLVULA.....	251
CHAVES DE CAIXA IMPACTO 1".....	157	CHAVES TUBULARES SEXTAVADAS X SEXTAVADAS.....	40	FERRAMENTAS PARA ABOCARDAR TUBOS.....	249
CHAVES DE CAIXA LONGAS 1/2" MÉTRICAS - 12 FACES.....	91	CINTA DE ROQUETE.....	257	FERRO DE SOLDAR.....	221
CHAVES DE CAIXA LONGAS 1/2" MÉTRICAS - SEXTAVADAS.....	91	CINTAS DE SUBSTITUIÇÃO.....	210	FITAS MÉTRICAS.....	173
CHAVES DE CAIXA LONGAS 1/2" POLEGADAS - 12 FACES.....	92	COMPOSIÇÃO MULTI-FERRAMENTAS - 124 PEÇAS.....	19	FUNIL DE ÓLEO.....	233
CHAVES DE CAIXA LONGAS 1/4" - 12 FACES - MÉTRICAS.....	63	COMPOSIÇÃO MULTI-FERRAMENTAS - 126 PEÇAS.....	19	FUNIL DE TORNEIRA.....	233
CHAVES DE CAIXA LONGAS 1/4" - 12 FACES - POLEGADAS.....	63	COMPOSIÇÃO PARA REPOSICIONAR ÊMBOLOS DE TRAVÕES.....	249		
CHAVES DE CAIXA LONGAS 1/4" - SEXTAVADAS - MÉTRICAS.....	62	COMPRESSOR DE MOLA.....	250		
CHAVES DE CAIXA LONGAS 1/4" - SEXTAVADAS - POLEGADAS.....	63	CONJUNTO DE 2 ALICATES - 1000 V ISOLADO - VDE.....	216		
CHAVES DE CAIXA LONGAS 1/4" - SEXTAVADAS - MÉTRICAS.....	62	CONJUNTO DE 3 ALICATES - 1000 V ISOLADO - VDE.....	217		
CHAVES DE CAIXA LONGAS 1/4" - SEXTAVADAS - POLEGADAS.....	63	CONJUNTO DE 4 ALICATES CIRCLIPS®.....	166		
CHAVES DE CAIXA LONGAS 1/4" - SEXTAVADAS - MÉTRICAS.....	62	CONJUNTO DE 4 PUXADORES DE BOBINAS DE IGNIÇÃO VAG.....	238		
CHAVES DE CAIXA LONGAS 1/4" - SEXTAVADAS - POLEGADAS.....	63	CORDA DE PIANO QUADRADA.....	261		
		CORTA-CABOS DE COBRE.....	214		

G

GAMA.....	112
GARRA FLEXÍVEL MAGNÉTICA DE LED.....	199
GARRA MAGNETICA FLEXIVEL COM LED.....	231
GARRAS.....	211
GAVETA PARA BANCADAS.....	13

I

ISOLADO 1000 V - VDE.....	217
JOGO DE 7 CHAVES MISTAS CURTAS - MM.....	25
JOGO DE 10 CHAVES BI-MATÉRIA FENDA-PHILLIPS®-POZIDRIV®.....	112

J

JOGO DE 10 CHAVES DE PARAFUSOS.....	104
JOGO DE 10 CHAVES DE PARAFUSOS ISOLADAS 1000 V PARA PARAFUSOS PHILLIPS®.....	218
JOGO DE 10 CHAVES MACHO SEXTAVADAS MÉTRICAS.....	119
JOGO DE 12 CHAVES MISTAS DE ROQUETE RÁPIDAS - MM.....	29
JOGO DE 12 CHAVES MISTAS LONGAS - MM.....	26
JOGO DE 12 FERRAMENTAS PARA A MANUTENÇÃO DE AIRBAGS.....	256
JOGO DE 12 LÂMINAS.....	193
JOGO DE 13 PONTAS DE MUDANÇA DE ÓLEO.....	234
JOGO DE 19 FERRAMENTAS PARA EXTRACÇÃO DE FICHAS DE CONECTORES.....	240
JOGO DE 2 ALICATES PARA MECÂNICO.....	160
JOGO DE 2 PARES DE VENTOSAS + CORREIA PARA PÁRA-BRISAS.....	257
JOGO DE 2 RODA-VÁLVULAS.....	246
JOGO DE 2 RODAS PARA CARRINHO DE INSPEÇÃO.....	229
JOGO DE 3 ALICATES PARA MECANICO.....	160
JOGO DE 3 CHAVES CRESCENTES BI-MATÉRIA.....	44
JOGO DE 3 CHAVES DE CAIXA HELICOIDAIS - 1/2".....	253
JOGO DE 3 CHAVES DE ROQUETE "4 EM 1" - MM.....	33
JOGO DE 3 CHAVES DINAMOMETRICAS PRÉ-REGULADAS.....	252
JOGO DE 3 EXTRATORES DE RÓTULA DE DIREÇÃO.....	253
JOGO DE 3 FERRAMENTAS PARA SENSORES DE CHUVA E DE LUMINOSIDADE.....	260
JOGO DE 3 LIMAS MEIO-MURÇO.....	187
JOGO DE 4 ALICATES PARA MECÂNICA.....	160
JOGO DE 4 ALICATES PARA MECÂNICO.....	160
JOGO DE 4 RASCADORES EM PLÁSTICO.....	255
JOGO DE 5 CHAVES ABERTAS SEXTAVADAS X SEXTAVADAS.....	43
JOGO DE 5 CHAVES BI-MATÉRIA FENDA-PHILLIPS®.....	113
JOGO DE 5 CHAVES BI-MATÉRIA FENDA-POZIDRIV®.....	114
JOGO DE 5 CHAVES DE PARAFUSOS.....	106
JOGO DE 5 CHAVES POLIGONAIS DE ROQUETE - MM.....	32
JOGO DE 5 LIMAS MEIO-MURÇO.....	187
JOGO DE 6 CHAVES DE CAIXA PARA VELAS DE PRÉ-AQUECIMENTO.....	237
JOGO DE 6 CHAVES DE FENDA DE PRECISÃO.....	222
JOGO DE 6 CHAVES DE PARAFUSOS.....	105
JOGO DE 6 CHAVES DE PARAFUSOS.....	105
JOGO DE 6 CHAVES DE PARAFUSOS ISOLADAS 1000 V.....	218
JOGO DE 6 CHAVES DE PARAFUSOS ISOLADAS 1000 V.....	218
JOGO DE 6 FERRAMENTAS PARA DESMONTAR GUARNIÇÕES.....	255
JOGO DE 6 SACA-TROÇOS.....	182
JOGO DE 6 VENTOSAS DE FIXAÇÃO DE PÁRA-BRISAS.....	258
JOGO DE 7 ALICATES E CHAVES DE FENDAS/PHILLIPS.....	161
JOGO DE 7 ALICATES PARA ABRAÇADEIRAS DE AUTO-APERTO.....	243
JOGO DE 7 CHAVES BI-MATÉRIA FENDA-PHILLIPS®.....	113
JOGO DE 7 CHAVES BI-MATÉRIA FENDA-POZIDRIV®.....	113
JOGO DE 7 CHAVES DE PARAFUSOS RÉSTORX®.....	107
JOGO DE 7 CHAVES DE PARAFUSOS TORX®.....	107
JOGO DE 7 CHAVES MACHO EM T COM CABO TORX® (1).....	124
JOGO DE 7 CHAVES MACHO SEXTAVADAS MÉTRICAS.....	117
JOGO DE 7 CHAVES MACHO TORX®.....	122

JOGO DE 7 CHAVES MISTAS DE ROQUETE CURTAS - MM.....	31
JOGO DE 8 CHAVES DE PARAFUSOS.....	104
JOGO DE 8 CHAVES DE PARAFUSOS.....	104
JOGO DE 8 CHAVES DE PARAFUSOS.....	105
JOGO DE 8 CHAVES MACHO SEXTAVADAS EM POLEGADAS.....	119
JOGO DE 8 CHAVES MACHO SEXTAVADAS EM POLEGADAS.....	120
JOGO DE 8 CHAVES MACHO TORX®.....	117
JOGO DE 8 PINÇAS DE OBTURAÇÃO.....	245
JOGO DE 9 CHAVES MACHO SEXTAVADAS MÉTRICAS.....	118
JOGO DE 9 CHAVES MACHO SEXTAVADAS MÉTRICAS.....	119
JOGO DE 9 CHAVES MACHO SEXTAVADAS MÉTRICAS.....	121
JOGO DE 9 CHAVES MISTAS - MM.....	27
JOGO DE ADAPTADORES MAGNÉTICOS - 3 PEÇAS.....	52
JOGO DE CHAVES DE BOCAS DIN - MM.....	37
JOGO DE CHAVES DE CAIXA - 1/4" - 13 PEÇAS.....	56
JOGO DE CHAVES DE CAIXA - 1/4" - 22 PEÇAS.....	56
JOGO DE CHAVES DE CAIXA 1/2" MÉTRICAS - 16 PEÇAS.....	78
JOGO DE CHAVES DE CAIXA 1/2" SEXTAVADAS - 8 PEÇAS.....	80
JOGO DE CHAVES DE CAIXA 1/4" - 3/8" - 9 PEÇAS.....	52
JOGO DE CHAVES DE CAIXA 3/8" SEXTAVADAS - 13 PEÇAS.....	67
JOGO DE CHAVES DE CAIXA DE IMPACTO 3/8" - 9 PEÇAS.....	148
JOGO DE CHAVES DE CAIXA DE IMPACTO EM EXPOSITOR 1" - 8 PEÇAS.....	156
JOGO DE CHAVES DE CAIXA DE IMPACTO TORX® 1/2" - 7 PEÇAS.....	150
JOGO DE CHAVES DE CAIXA E ACESSÓRIOS 1/4" - 1/2" - 98 PEÇAS.....	51
JOGO DE CHAVES DE CAIXA EM EXPOSITOR 1/2" - 18 PEÇAS.....	83
JOGO DE CHAVES DE CAIXA JANTES DE LIGA 17, 19, 21 MM - QUADRADO 1/2".....	253
JOGO DE CHAVES DE CAIXA LONGAS DE IMPACTO EM EXPOSITOR 1" - 4 PEÇAS.....	156
JOGO DE CHAVES DE CAIXA SEXTAVADAS 1/2" - 6 PEÇAS.....	80
JOGO DE CHAVES DE CAIXA TORX® 1/2" - 9 PEÇAS.....	80
JOGO DE CHAVES DE CAIXA TORX® 1/4" - 3/8" - 1/2" - 13 PEÇAS.....	51
JOGO DE CHAVES DE CAIXA TORX® 3/8" - 4 PEÇAS.....	75
JOGO DE CHAVES MACHO EM T SEXTAVADAS.....	126
JOGO DE CHAVES MACHO RÉSTORX® EM SUPORTE PLÁSTICO.....	122
JOGO DE CHAVES MISTAS DE ROQUETE - MM.....	28
JOGO DE CHAVES MISTAS DE ROQUETE ARTICULADAS - MM.....	30
JOGO DE DOIS ALICATES COM TUBOS FLEXÍVEIS.....	244
JOGO DE VENTOSAS DE FIXAÇÃO DE VIDROS LATERAIS.....	259
JOGOS DE 6 CHAVES MACHO EM T COM CABO SEXTAVADAS DE CABEÇA ESFÉRICA (1).....	124
JOGOS DE 7 CHAVES MACHO EM T COM CABO.....	35
JOGOS DE CHAVES DE BOCAS - MM.....	35
JOGOS DE CHAVES DE CACHIMBO ABERTAS.....	40
JOGOS DE CHAVES DE CAIXA.....	64
JOGOS DE CHAVES MISTAS.....	24
JOGOS DE CHAVES POLIGONAIS CURVAS - MM.....	38

K

KIT APARELHO DE TESTE DO SISTEMA DE REFRIGERAÇÃO.....	245
KIT DE ABERTURA DE PORTAS - 9 PEÇAS.....	256
KIT DE REPARAÇÃO PARA CÂRTERES DE ÓLEO - 64 PEÇAS.....	233
KIT DE REPARAÇÃO PARA VELAS DE IGNIÇÃO - 16 PEÇAS.....	238
KIT EXTRACTOR DE ROLAMENTO - TODAS AS MARCAS.....	254
KIT EXTRACTOR DE ROLAMENTO - VIATURAS FRANCESAS.....	254
KITS DE REPARAÇÃO DE ROQUETES.....	139

L

LÂMINA - 150 MM.....	187
LÂMINA BI-METÁLICA - 300 MM.....	186
LÂMINA SOBRESSELENTE.....	215
LÂMINAS DE X-ACTO.....	262
LÂMINAS DE X-ACTOS 18 MM.....	192
LÂMINAS DE X-ACTOS 9 MM.....	192
LÂMINAS PARA CORTA-REBITES.....	189
LÂMINAS SOBRESSELENTE PARA RASCADOR.....	204
LÂMINAS SOBRESSELENTE PARA RASCADOR.....	263
LÂMPADA MAGNETIC.....	200
LANTERNA.....	197
LANTERNA DE INSPEÇÃO FLEXÍVEL.....	198
LANTERNA FLEXÍVEL.....	201
LANTERNA FLEXÍVEL ULTRAVIOLETA.....	201
LANTERNA RECARREGAVEL USB E201406.....	266
LANTERNA-CANETA.....	198
LANTERNA-CANETA RECARREGÁVEL POR USB.....	199
LIMA QUADRADA MEIO-MURÇO.....	188
LIMA TRIANGULAR MEIO-MURÇO.....	189
LIMAS MEIA-CANA.....	188
LIMAS PLANAS.....	188
LIMAS REDONDAS.....	188
LIXADORA ORBITAL 15 MM - 5 MM.....	146
LOTE DE 5 CAVILHAS METÁLICOS E 5 ANÉIS PARA CHAVES DE CAIXA DE IMPACTO 1".....	157

M

MACACO DE RODAS DE 3T.....	228
MAÇOS DE ARESTAS QUEBRADAS.....	180
MAÇOS SEM RECOCHETE.....	181
MALA DE MANUTENÇÃO.....	204
MALA DE MANUTENÇÃO 142 FERRAMENTAS.....	18
MALA DE MANUTENÇÃO 96 FERRAMENTAS.....	18
MANIVELA 1/2".....	86
MANIVELA 3/8".....	69
MARTELO DE COBRE.....	180
MARTELO DE PENNA.....	179
MARTELOS.....	273
MARTELOS COM BATENTES INTERMUTÁVEIS.....	181
MARTELOS COM CABEÇA EM FORMA DE BOLA.....	179
MARTELOS DE PENNA.....	178
MINI CHAVE PLANA.....	116
MINI LANTERNA FLEXÍVEL DE LEDS COM BASE MAGNÉTICA.....	201
MINI PORTA-PONTAS DE ROQUETE 1/4".....	132
MINI RASCADOR.....	263
MINI VENTOSA MULTIUSOS.....	259
MINI-CHAVE DE PARAFUSOS PORTA-PONTAS DE ROQUETE.....	134
MINI-RASCADOR E201209.....	266
MINI-SERRA - 1 LÂMINA.....	186
MOCHILA COM RODAS.....	17
MÓDULO CHAPARIA 2/3.....	172
MÓDULO DE 11 CHAVES DE BOCAS.....	35
MÓDULO DE 12 CHAVES MISTAS DE ROQUETE.....	33
MÓDULO DE 2 ALICATES AJUSTÁVEL/PRESSÃO.....	161
MÓDULO DE 4 ALICATES CIRCLIPS®.....	166
MÓDULO DE 4 ALICATES PARA MECÂNICA.....	161
MÓDULO DE 4 LIMAS.....	187
MÓDULO DE 6 CHAVES DE PARAFUSOS.....	107
MÓDULO DE 7 CHAVES MACHO EM T COM CABO TORX® (1).....	125
MÓDULO DE 7 CHAVES MISTAS DE ROQUETE E 1 CHAVE INGLESA.....	33
MÓDULO DE 8 CHAVES DE PARAFUSOS.....	106
MÓDULO DE 8 CHAVES LUNETA.....	38
MÓDULO DE 8 CHAVES MACHO EM T COM CABO SEXTAVADAS (1).....	123
MÓDULO DE ACESSÓRIOS 1/2" MÉTRICOS - 8 PEÇAS.....	81
MÓDULO DE ALICATES AJUSTÁVEL PRESSÃO.....	161
MÓDULO DE CHAVES DE CAIXA DE IMPACTO - 1/2" - 17 PEÇAS.....	150

MÓDULO DE CHAVES DE CAIXA DE IMPACTO 1/2" - 25 PEÇAS	150
MÓDULO DE CHAVES DE CAIXA E ACESSÓRIOS - 1/4" - 3/8" MÉTRICAS - 62 PEÇAS	50
MÓDULO DE CHAVES DE CAIXA E ACESSÓRIOS - 1/4" - 45 PEÇAS	57
MÓDULO DE CHAVES DE CAIXA E ACESSÓRIOS - 1/4" - 67 PEÇAS	57
MÓDULO DE CHAVES DE CAIXA E ACESSÓRIOS 1/2" MÉTRICAS - 21 PEÇAS	81
MÓDULO DE CHAVES DE CAIXA E ACESSÓRIOS - 1/4" - 3/8" MÉTRICAS - 62 PEÇAS	50
MÓDULO DE CHAVES DE CAIXA E ACESSÓRIOS 3/8" MÉTRICAS - 50 PEÇAS	67
MÓDULO DE CHAVES DE CAIXA E ACESSÓRIOS DE IMPACTO 1/2" - 26 PEÇAS	150
MÓDULO DE CHAVES DE CAIXA LONGAS 1/2" MÉTRICAS - 10 PEÇAS	81
MÓDULO DE CHAVES DE CAIXA TORX® 1/2" MÉTRICAS - 33 PEÇAS	81
MÓDULO DE CHAVES MACHO	127
MÓDULO DE ESPUMA DE CHAVES DE CAIXA CURTAS DE IMPACTO 3/4" - 11 PEÇAS	153
MÓDULO DE ESPUMA DE CHAVES DE CAIXA CURTAS DE IMPACTO 1/2" - 11 PEÇAS	149
MÓDULO DE ESPUMA DE MUDANÇA DE ÓLEO	235
MÓDULO DE ESPUMA DE RODAS	251
MÓDULO ESPUMA DE CHAVES DE CAIXA DE IMPACTO 1/2" - 10 PEÇAS	149
MÓDULOS DE CHAVES MISTAS	25
MÓDULOS FERRAMENTAS DE PANCADA	178
MORDENTES LONGOS	168
MULTÍMETRO DE PINÇA	241
MULTÍMETRO DIGITAL	241
MULTIPLICADORES DE BINÁRIO	139

N

NAVALHA DE ELECTRICISTA 1 LÂMINA	220
NAVALHA DE ELECTRICISTA 2 LÂMINAS	220
NAVALHA DE ELECTRICISTA COM DESCARNADOR	220
NÍVEIS MAGNÉTICOS	173

O

ORIFLAMES	267
OUTRAS	273

P

PAD PROTEÇÃO NO JOELHO	229
PAINEL E900309	267
PAQUÍMETRO PARA DISCOS DE TRAVÃO	250
PAQUÍMETRO UNIVERSAL 1/20 - 0,05 MM	174
PAR DE PREGUIÇAS DE CREMALHEIRA	229
PAR DE VENTOSAS	257
PARAFUSOS SEXTAVADOS INTERIORES	75
PASSADOR	42
PEÇAS SOBRESSELENTES PARA COMPRESSOR DE MOLA	250
PEGA ARTICULADA 3/8"	70
PEGA CURVA 1/2"	86
PEGA CURVA COM CABO 1/2"	86
PESA-ÁCIDO	240
PESA-ANTICONGELANTE	245
PINÇA LONGA MODELO A DIREITO - 160 MM	223
PINÇA LONGA MODELO CURVO - 155 MM	223
PINÇA MODELO A DIREITO	223
PISTOLA DE SILICONE	207
PISTOLA PARA MASSA	207
PISTOLA PNEUMÁTICA DE REBITAR	146
PISTOLA SILICONE	263
PONTA DE MUDANÇA DE ÓLEO 3/8" QUADRADA FEMEA - 10 MM	234
PONTA DE MUDANÇA DE ÓLEO 3/8" TRIANGULAR MACHO - 10 MM	234

PONTA DE MUDANÇA DE ÓLEO 3/8" XZN® MACHO - 16 MM	234
PONTA QUADRADA	174
PONTAS DE APARAFUSAR TORX® - 25 MM - 1/4"	131
PONTAS DE MUDANÇA DE ÓLEO 3/8" QUADRADAS	234
PONTAS DE MUDANÇA DE ÓLEO 3/8" SEXTAVADAS MACHO	234
PONTAS DE PERFIL SEXTAVADO 50 MM - 1/4"	132
PONTAS DE TORÇÃO PHILLIPS® 25 MM - 1/4"	130
PONTAS DE TORÇÃO POZIDRIV® 25 MM - 1/4"	130
PONTAS PARA FENDA 25 MM - 1/4"	130
PONTAS PARA PARAFUSOS PERFIL POZIDRIV® 25 MM - 1/4"	128
PONTAS PHILLIPS® 50 MM - 1/4"	131
PONTAS POZIDRIV® 50 MM - 1/4"	131
PONTAS RESISTORX® 25 MM - 1/4"	131
PONTAS SEMI-REDONDAS - ALICATE CURVO DE 40°	164
PONTAS SEMIRREDONDAS - ALICATE ANGULAR DE 40° - ISOLADO 1000 V - VDE	217
PONTAS SEXTAVADAS 25 MM - 1/4"	130
PONTAS SOBRESSELENTES	221
PONTEIROS DE TRAÇAR AÇO - 210 MM	175
PORTA-BATERIA UNIVERSAL	239
PORTA-CHAVES DE CAIXA 1/4"	135
PORTA-PONTAS COM BLOQUEIO 1/4"	135
PORTA-PONTAS MAGNÉTICO 1/4"	135
PRATELEIRA INCLINADA	265
PRATELEIRA PARA CHAVES DE FENDA	265
PROJETOR DE CABO 35W	196
PROJETOR RECARREGÁVEL 15W EM SUPORTE	196
PROTEÇÃO DE PAINEL DE INSTRUMENTOS	262
PROTEÇÃO DE GRELHA	230
PULVERIZADOR PROFISSIONAL	228
PUNÇÃO-DE-BICO	182
PUNÇÕES AUTOMÁTICOS	183
PUNHO ARTICULADO 3/4"	97
PURGADOR DE TRAVÃO DE DEPRESSÃO	248
PURGADOR DE TRAVÃO DE DEPRESSÃO	248

R

RABO DE FORÇA ARTICULADO 1/2"	85
RASCADOR	204
RASCADOR	263
RECIPIENTE DE RECUPERAÇÃO DO LÍQUIDO DE REFRIGERAÇÃO	245
RECIPIENTE DE RECUPERAÇÃO E ARMAZENAMENTO DO ÓLEO DA MUDANÇA DE ÓLEO	232
RECIPIENTE PLÁSTICO	232
RECIPIENTE RECUPERADOR DO ÓLEO	232
REDUTOR 1" - 3/4"	101
REDUTOR 1/2" - 3/8"	88
REDUTOR 3/4" - 1/2"	97
REDUTOR 3/8" - 1/4"	71
REDUTOR DE IMPACTO - 3/4" - 1/2"	154
REDUTOR DE IMPACTO 1" - 3/4"	154
RÉGUA FLEXÍVEL - 200 MM	174
REGULÁVEIS MORDENTES CURTOS	168
RETIFICADORA ANGULAR COM PINÇA 1/4"	145
RETIFICADORA DIREITA 1/4"	145
RISCADOR COM PONTA EM CARBONETO - TIPO LÁPIS - 150 MM	175
RODA DIAM.125 - M14"	145
ROQUETE ARTICULADO 1/2"	85
ROQUETE 1"	100
ROQUETE 3/4"	96
ROQUETE COM BLOQUEIO - 1/2" CABO EM METAL	84
ROQUETE COM BLOQUEIO 1/2"	84
ROQUETE COM BLOQUEIO 1/4"	58
ROQUETE COM BLOQUEIO 3/8"	68
ROQUETE COM CABEÇA ARTICULADA 3/8"	69
ROQUETE COM CABO 3/4"	95
ROQUETE COM MECANISMO BLOQUEIO - 1/4" CABO EM METAL	58
ROQUETE COM MECANISMO BLOQUEIO -	

3/8" CABO EM METAL	68
ROQUETE DE CABEÇA ARTICULADA 1/2"	85
ROQUETE DE CABEÇA ARTICULADA 1/4"	58
ROQUETE DE CABEÇA ARTICULADA 3/8"	69
ROQUETE DE CABEÇA REDONDA 1/2"	84
ROQUETE DE CABEÇA REDONDA 1/4"	58
ROQUETE DE CABEÇA REDONDA 3/8"	68
ROQUETE PNEUMÁTICO "MINI" 1/4"	146
ROQUETE PNEUMÁTICO "MINI" 3/8"	147
ROQUETE PNEUMÁTICO 1/2"	147
ROQUETE PNEUMÁTICO 3/8"	147

S

SACA-TROÇOS	182
SELEÇÃO EM ESTOJO DE PONTAS 1/4" - 19 PEÇAS	129
SELEÇÃO EM ESTOJO DE PONTAS 1/4" - 32 PEÇAS	129
SELEÇÃO EM ESTOJO DE PONTAS 1/4" - 39 PEÇAS	128
SERINGA PARA MUDANÇA DE LÍQUIDOS	248
SERINGA PARA MUDANÇA DE ÓLEO	232
SERROTE DE ARCO - 1 LÂMINA	186
SERROTE DE ARCO - CABO DE MADEIRA + 1 LÂMINA	186
SEXTAVADAS MÉTRICAS (1)	123
SISTEMA DE ILUMINAÇÃO DE LED'S - 2 NÍVEIS DE ILUMINAÇÃO	200
SUPORTE DE CHÃO	197
SUPORTE MAGNÉTICO PARA CHAVES DE IMPACTO 1/2"	142
SUPORTE MÓVEL PARA PÁRA-BRISAS	257

T

TABULEIROS MAGNÉTICOS EXTENSÍVEIS	14
TERMÓMETRO INFRAVERMELHOS	240
TESOURA AVIAÇÃO CORTE À DIREITA	172
TESOURA AVIAÇÃO CORTE À DIREITA - LONGO ALCANCE	190
TESOURA CORTA-TUDO	193
TESOURA DE RECORTE	191
TESOURA PARA CHAPA SEMI-UNIVERSAL	191
TESOURA PARA CHAPA UNIVERSAL	191
TESOURAS	193
TESOURAS AVIAÇÃO	190
TESOURAS DE DUPLA MATÉRIA	221
TESOURAS DE ELECTRICISTA	221
TESOURAS DESMULTIPLICADAS PARA RECORTE	190
TESTADOR DE BATERIA	240
TORNOS	205
TROLE DE 4 RODAS	228
TURQUESAS RUSSAS	168

V

VENTOSA DE BOMBA PL	258
VENTOSA MULTIUSOS	259
VERIFICADOR DE TENSÃO	242

X

X SEXTAVADAS	39
X-ACTO 18 MM	192
X-ACTO 9 MM	192
X-ACTO DE PÁRA-BRISAS PARA CORTE A FRIO	262
X-ATO DE SEGURANÇA	193

E003601.....	175	E030104.....	64	E030313.....	63	E030944.....	73	E031803.....	67	E031984.....	92
E010101.....	9	E030105.....	64	E030314.....	63	E030945.....	73	E031804.....	66	E032001.....	90
E010105.....	8	E030106.....	64	E030315.....	63	E030946.....	73	E031805.....	66	E032101.....	237
E010108.....	15	E030107.....	64	E030316.....	63	E030947.....	73	E031806.....	66	E032102.....	237
E010118.....	12	E030108.....	64	E030317.....	63	E030948.....	73	E031807.....	75	E032103.....	91
E010119.....	12	E030109.....	64	E030318.....	63	E030949.....	73	E031821.....	67	E032201.....	81
E010121.....	12	E030110.....	64	E030322.....	63	E030950.....	73	E031901.....	93	E032203.....	91
E010128.....	16	E030111.....	64	E030508.....	58	E030951.....	73	E031902.....	93	E032401.....	237
E010129.....	16	E030112.....	65	E030509.....	59	E030952.....	73	E031903.....	93	E032402.....	237
E010131.....	9	E030113.....	65	E030601.....	58	E030953.....	73	E031904.....	93	E032701.....	85
E010136.....	16	E030114.....	65	E030602.....	58	E031105.....	74	E031905.....	93	E032702.....	86
E010161.....	12	E030115.....	65	E030605.....	58	E031301.....	73	E031906.....	93	E032709.....	84
E010192.....	9	E030116.....	65	E030700.....	55	E031302.....	73	E031907.....	93	E032711.....	87
E010193.....	9	E030117.....	65	E030702.....	54	E031303.....	73	E031908.....	93	E032713.....	86
E010194.....	10	E030118.....	65	E030703.....	64	E031304.....	73	E031909.....	93	E032714.....	86
E010201.....	17	E030119.....	65	E030704.....	64	E031305.....	73	E031910.....	93	E032801.....	84
E010202.....	17	E030120.....	65	E030707.....	54	E031306.....	73	E031911.....	93	E032802.....	85
E010203.....	17	E030121.....	65	E030715.....	57	E031307.....	73	E031912.....	93	E032803.....	85
E010204.....	17	E030122.....	65	E030727.....	56	E031308.....	73	E031913.....	93	E032804.....	85
E010209.....	17	E030123.....	65	E030901.....	75	E031309.....	73	E031914.....	93	E032805.....	85
E010304.....	18	E030124.....	65	E030902.....	75	E031310.....	73	E031915.....	93	E032808.....	84
E010305.....	18	E030125.....	65	E030903.....	75	E031311.....	73	E031916.....	93	E032900.....	77
E010402.....	13	E030126.....	65	E030904.....	75	E031312.....	73	E031917.....	93	E032902.....	78
E010404.....	13	E030127.....	65	E030905.....	75	E031313.....	73	E031918.....	93	E032904.....	80
E010405.....	13	E030128.....	65	E030906.....	75	E031334.....	73	E031919.....	93	E032906.....	80
E010601.....	18	E030129.....	64	E030907.....	75	E031501.....	74	E031920.....	93	E032907.....	78
E010602.....	18	E030130.....	64	E030908.....	75	E031502.....	74	E031921.....	93	E032908.....	77
E011001.....	15	E030131.....	64	E030909.....	76	E031503.....	74	E031922.....	93	E032909.....	77
E020101.....	186	E030132.....	64	E030910.....	76	E031504.....	74	E031923.....	93	E032911.....	50
E020103.....	187	E030133.....	64	E030911.....	76	E031505.....	74	E031924.....	93	E032922.....	81
E020301.....	192	E030134.....	64	E030912.....	76	E031506.....	74	E031925.....	93	E032924.....	81
E020302.....	192	E030142.....	65	E030913.....	76	E031507.....	74	E031926.....	93	E032936.....	80
E020303.....	192	E030143.....	65	E030914.....	76	E031508.....	74	E031927.....	92	E032937.....	83
E020304.....	192	E030144.....	65	E030915.....	76	E031509.....	74	E031928.....	92	E032938.....	83
E020305.....	206	E030145.....	65	E030916.....	76	E031510.....	74	E031929.....	92	E032939.....	82
E020306.....	193	E030146.....	65	E030917.....	76	E031511.....	74	E031930.....	92	E032940.....	82
E020307.....	193	E030147.....	65	E030918.....	76	E031512.....	74	E031931.....	92	E032941.....	80
E020308.....	164	E030148.....	65	E030919.....	76	E031513.....	74	E031932.....	92	E032942.....	83
E020309.....	164	E030149.....	65	E030920.....	76	E031514.....	74	E031933.....	92	E032943.....	82
E020310.....	164	E030150.....	64	E030921.....	76	E031515.....	74	E031934.....	92	E033503.....	99
E020602.....	188	E030151.....	64	E030922.....	76	E031516.....	74	E031935.....	92	E033504.....	99
E020603.....	188	E030201.....	61	E030923.....	76	E031517.....	74	E031936.....	89	E033505.....	99
E020604.....	188	E030202.....	61	E030924.....	76	E031518.....	74	E031936C.....	274	E033506.....	99
E020605.....	188	E030203.....	61	E030925.....	76	E031519.....	74	E031937.....	89	E033507.....	99
E020607.....	188	E030204.....	61	E030926.....	76	E031520.....	74	E031938.....	89	E033508.....	99
E020608.....	188	E030205.....	61	E030927.....	76	E031521.....	74	E031967.....	94	E033509.....	99
E020609.....	188	E030206.....	61	E030928.....	75	E031522.....	74	E031968.....	94	E033510.....	99
E020610.....	189	E030207.....	61	E030929.....	75	E031523.....	74	E031969.....	94	E033511.....	99
E020611.....	187	E030210.....	61	E030930.....	75	E031524.....	74	E031970.....	94	E033512.....	99
E020612.....	187	E030211.....	61	E030931.....	75	E031525.....	74	E031971.....	94	E033513.....	99
E020613.....	187	E030216.....	63	E030932.....	76	E031526.....	74	E031972.....	94	E033514.....	99
E020901.....	193	E030217.....	63	E030933.....	72	E031527.....	74	E031973.....	94	E033515.....	99
E020902.....	190	E030218.....	63	E030934.....	75	E031528.....	74	E031974.....	94	E033516.....	99
E020903.....	190	E030219.....	63	E030935.....	73	E031602.....	70	E031975.....	94	E033517.....	99
E020904.....	190	E030220.....	63	E030936.....	73	E031603.....	70	E031976.....	94	E033518.....	99
E020905.....	190	E030221.....	63	E030937.....	73	E031604.....	69	E031977.....	94	E033801.....	98
E020906.....	190	E030222.....	63	E030938.....	73	E031612.....	68	E031978.....	94	E033802.....	98
E020907.....	191	E030223.....	63	E030939.....	73	E031614.....	71	E031979.....	94	E033803.....	101
E020908.....	191	E030224.....	63	E030940.....	73	E031701.....	68	E031980.....	94	E033804.....	97
E030101.....	64	E030310.....	63	E030941.....	73	E031702.....	69	E031981.....	94	E034101.....	101
E030102.....	64	E030311.....	63	E030942.....	73	E031703.....	69	E031982.....	93	E034102.....	101
E030103.....	64	E030312.....	63	E030943.....	73	E031706.....	68	E031983.....	93	E034103.....	101

ÍNDICE ALFANUMÉRICO

E034104.....	101	E050106.....	215	E090106.....	208	E110111.....	25	E110936.....	32	E112817.....	42	E113257.....	34
E034105.....	101	E050301.....	214	E090107.....	208	E110113.....	25	E110937.....	32	E112818.....	43	E113258.....	34
E034106.....	101	E050302.....	214	E090108.....	208	E110115.....	25	E110938.....	32	E112819.....	43	E113259.....	34
E034107.....	101	E050504.....	216	E090109.....	208	E110201.....	23	E110939.....	32	E112820.....	43	E113260.....	34
E034108.....	101	E050406.....	216	E090110.....	208	E110202.....	23	E110940.....	32	E112821.....	43	E113261.....	34
E034109.....	101	E050407.....	216	E090111.....	208	E110203.....	23	E110943.....	32	E112822.....	43	E113262.....	34
E034501.....	101	E050408.....	216	E090112.....	208	E110204.....	23	E110944.....	32	E112823.....	43	E113265.....	34
E034502.....	101	E050409.....	216	E090113.....	208	E110205.....	23	E110945.....	32	E112824.....	43	E113267.....	34
E034503.....	100	E050410.....	217	E090114.....	208	E110206.....	23	E110961.....	45	E112825.....	43	E113268.....	34
E034601.....	100	E050411.....	217	E090115.....	208	E110300.....	24	E110961.....	205	E112826.....	43	E113272.....	34
E034701.....	100	E050412.....	217	E090116.....	208	E110302.....	24	E110962.....	45	E112827.....	43	E113275.....	34
E034801.....	51	E050413.....	217	E090302.....	172	E110303.....	26	E110962.....	205	E112828.....	43	E113279.....	34
E034802.....	52	E050414.....	217	E090303.....	206	E110304.....	25	E111100.....	33	E112829.....	43	E113281.....	34
E034805.....	51	E050415.....	216	E090401.....	205	E110306.....	24	E111101.....	29	E112830.....	43	E113282.....	34
E034806.....	19	E050416.....	217	E090402.....	205	E110309.....	24	E111102.....	30	E112831.....	43	E113285.....	34
E034806.....	204	E050502.....	217	E090403.....	205	E110310.....	24	E111103.....	32	E112832.....	43	E113286.....	34
E034835.....	19	E050608.....	219	E090404.....	205	E110313.....	24	E111104.....	31	E112901.....	42	E113287.....	34
E034837.....	78	E051301.....	241	E090501.....	221	E110323.....	24	E111106.....	28	E112902.....	42	E113288.....	34
E034853.....	50	E051401.....	199	E090502.....	221	E110326.....	24	E111107.....	28	E112903.....	42	E113289.....	35
E034855.....	53	E051401.....	231	E090701.....	207	E110327.....	24	E111108.....	30	E113200.....	22	E113290.....	35
E040601.....	150	E051402.....	231	E090702.....	207	E110701.....	26	E111115.....	33	E113201.....	22	E113291.....	35
E041101.....	155	E051501.....	231	E090703.....	207	E110702.....	26	E111201.....	34	E113202.....	22	E113292.....	35
E041102.....	155	E051601.....	193	E090703.....	263	E110703.....	26	E111202.....	34	E113204.....	22	E113293.....	35
E041103.....	155	E069253.....	118	E090705.....	207	E110704.....	26	E111203.....	34	E113205.....	22	E113294.....	35
E041104.....	155	E080205.....	163	E096002.....	211	E110705.....	26	E111220.....	36	E113206.....	22	E113295.....	35
E041105.....	155	E080206.....	163	E096003.....	211	E110706.....	26	E111222.....	35	E113207.....	22	E113296.....	35
E041106.....	155	E080207.....	163	E096004.....	211	E110707.....	26	E111406.....	35	E113208.....	22	E113297.....	35
E041301.....	155	E080208.....	163	E096005.....	211	E110708.....	26	E111500.....	37	E113209.....	22	E113298.....	35
E041302.....	155	E080209.....	163	E096006.....	211	E110709.....	26	E111501.....	37	E113210.....	22	E113299.....	35
E041303.....	155	E080210.....	163	E096007.....	211	E110710.....	26	E111502.....	37	E113211.....	22	E113300.....	28
E041501.....	154	E080211.....	163	E096008.....	211	E110711.....	26	E111503.....	37	E113212.....	22	E113301.....	28
E041502.....	154	E080407.....	165	E096009.....	211	E110901.....	30	E111708.....	38	E113213.....	22	E113302.....	28
E041503.....	154	E080408.....	165	E096010.....	211	E110902.....	30	E111709.....	38	E113214.....	22	E113303.....	28
E041505.....	60	E080409.....	164	E096011.....	211	E110903.....	30	E111710.....	38	E113215.....	22	E113304.....	28
E041506.....	71	E080410.....	164	E096012.....	211	E110904.....	30	E111714.....	38	E113216.....	22	E113305.....	28
E041507.....	88	E080411.....	165	E100103.....	139	E110905.....	30	E112201.....	39	E113217.....	22	E113306.....	28
E041601.....	148	E080412.....	165	E100104.....	139	E110906.....	30	E112301.....	43	E113218.....	22	E113307.....	28
E041602.....	148	E080503.....	162	E100105.....	138	E110907.....	30	E112501.....	44	E113219.....	22	E113308.....	28
E041603.....	148	E080504.....	162	E100106.....	138	E110908.....	30	E112601.....	45	E113220.....	22	E113309.....	28
E041604.....	150	E080505.....	162	E100107.....	138	E110909.....	30	E112602.....	45	E113221.....	22	E113310.....	28
E041605.....	150	E080701.....	169	E100108.....	138	E110910.....	30	E112603.....	45	E113222.....	22	E113311.....	28
E041644.....	150	E080801.....	161	E100109.....	138	E110911.....	30	E112604.....	45	E113223.....	22	E113312.....	23
E041647.....	156	E080815.....	160	E100110.....	138	E110912.....	30	E112605.....	44	E113224.....	22	E113313.....	23
E041648.....	156	E080816.....	160	E100114.....	252	E110914.....	31	E112606.....	44	E113225.....	22	E113314.....	23
E041649.....	52	E080817.....	160	E100115.....	246	E110916.....	31	E112607.....	44	E113226.....	22	E113315.....	23
E042204.....	157	E080818.....	160	E100116.....	246	E110917.....	31	E112703.....	44	E113228.....	22	E113316.....	23
E042207.....	157	E080819.....	161	E100203.....	139	E110918.....	31	E112801.....	42	E113229.....	22	E113317.....	23
E042208.....	157	E080820.....	166	E100204.....	139	E110919.....	31	E112802.....	42	E113230.....	23	E113318.....	23
E042209.....	157	E080821.....	161	E100501.....	138	E110921.....	31	E112803.....	42	E113235.....	23	E113319.....	23
E042211.....	157	E084648.....	162	E100502.....	138	E110923.....	31	E112804.....	42	E113236.....	23	E113321.....	37
E042213.....	157	E084649.....	162	E100503.....	138	E110924.....	29	E112805.....	42	E113238.....	24	E113322.....	37
E042215.....	157	E084807.....	168	E100504.....	138	E110925.....	29	E112806.....	42	E113239.....	24	E113323.....	37
E042216.....	157	E084808.....	168	E100505.....	138	E110926.....	29	E112807.....	42	E113240.....	24	E113324.....	37
E042304.....	157	E084809.....	168	E100506.....	138	E110927.....	29	E112808.....	42	E113241.....	24	E113325.....	37
E042307.....	157	E084812.....	168	E110101.....	22	E110928.....	29	E112809.....	42	E113242.....	24	E113326.....	37
E042308.....	157	E084813.....	168	E110102.....	22	E110929.....	29	E112810.....	42	E113250.....	34	E113328.....	37
E042310.....	157	E084815.....	169	E110103.....	22	E110930.....	29	E112811.....	42	E113251.....	34	E113329.....	37
E042401.....	157	E084816.....	169	E110104.....	22	E110931.....	29	E112812.....	42	E113252.....	34	E113358.....	23
E042402.....	156	E090101.....	210	E110106.....	25	E110932.....	29	E112813.....	42	E113253.....	34	E113359.....	23
E050103.....	215	E090102.....	210	E110108.....	25	E110933.....	29	E112814.....	42	E113254.....	34	E113360.....	23
E050104.....	215	E090104.....	209	E110109.....	25	E110934.....	29	E112815.....	42	E113255.....	34	E113361.....	23
E050105.....	215	E090105.....	209	E110110.....	25	E110935.....	29	E112816.....	42	E113256.....	34	E113362.....	23

E117298.....61	E117725.....27	E117829.....210	E121506.....116	E150108.....179	E160305.....110	E165138.....108
E117299.....61	E117726.....27	E117830.....210	E121507.....116	E150109.....179	E160340.....115	E165141.....108
E117350.....61	E117727.....27	E117877.....224	E121517.....116	E150110.....179	E160341.....115	E165204.....110
E117351.....61	E117728.....27	E117878.....224	E121601.....123	E150111.....180	E160342.....115	E165206.....110
E117352.....61	E117729.....27	E117879.....225	E121602.....123	E150112.....180	E160401.....111	E165207.....110
E117353.....61	E117730.....27	E117880.....225	E121603.....123	E150113.....180	E160402.....111	E165209.....110
E117354.....61	E117731.....27	E117881.....151	E121604.....123	E150114.....180	E160403.....111	E165319.....111
E117355.....59	E117732.....27	E117882.....225	E121605.....123	E150115.....181	E160410.....115	E165335.....111
E117356.....59	E117733.....27	E117883.....224	E121606.....123	E150116.....181	E160411.....115	E165337.....111
E117358.....60	E117734.....27	E117884.....151	E121607.....123	E150301.....181	E160412.....115	E165340.....109
E117359.....60	E117735.....27	E117903.....214	E121608.....123	E150302.....181	E160501.....109	E165395.....109
E117360.....60	E117736.....27	E117905.....44	E121609.....123	E150303.....181	E160502.....109	E165396.....109
E117361.....70	E117737.....27	E117906.....44	E121610.....124	E150304.....181	E160503.....109	E165397.....109
E117363.....70	E117738.....27	E117908.....167	E121611.....124	E150305.....181	E160504.....109	E165398.....109
E117364.....70	E117739.....27	E117909.....167	E121612.....124	E150306.....181	E160505.....109	E165399.....109
E117365.....71	E117740.....27	E117910.....167	E121613.....124	E150307.....181	E160506.....109	E165400.....109
E117366.....72	E117741.....27	E117911.....167	E121614.....124	E150308.....181	E160507.....109	E165404.....109
E117367.....72	E117742.....27	E117912.....166	E121615.....124	E150501.....182	E160508.....109	E165406.....110
E117368.....43	E117743.....27	E117913.....166	E121616.....124	E150502.....182	E160509.....109	E165407.....110
E117370.....28	E117744.....27	E117914.....166	E121617.....123	E150503.....183	E160510.....109	E165408.....111
E117371.....28	E117750.....189	E117915.....166	E121701.....125	E150504.....183	E160511.....109	E165409.....111
E117372.....28	E117751.....189	E117916.....167	E121702.....125	E150701.....183	E160601.....109	E165410.....219
E117373.....28	E117752.....189	E117917.....167	E121703.....125	E150702.....183	E160801.....134	E165411.....219
E117374.....28	E117753.....189	E117918.....167	E121704.....125	E150703.....183	E160802.....133	E165412.....219
E117376.....37	E117754.....189	E117919.....167	E121705.....125	E150704.....183	E160803.....134	E165413.....219
E117377.....28	E117755.....189	E117920.....167	E121706.....125	E150801.....178	E160804.....133	E165414.....219
E117378.....28	E117756.....189	E117921.....167	E121707.....125	E150802.....178	E160901.....106	E165415.....219
E117381.....35	E117757.....189	E117922.....167	E121708.....125	E150803.....178	E160902.....105	E165416.....219
E117382.....35	E117758.....189	E117923.....167	E121709.....124	E150901.....205	E160903.....105	E165417.....219
E117386.....39	E117759.....189	E120101.....121	E130101.....130	E150901.....230	E160904.....104	E165418.....219
E117387.....39	E117760.....189	E120102.....121	E130102.....130	E150902.....205	E160905.....104	E165419.....219
E117388.....43	E117762.....220	E120103.....121	E130103.....130	E151002.....180	E160906.....104	E165420.....219
E117391.....43	E117763.....220	E120301.....118	E130104.....130	E151003.....180	E160907.....105	E165421.....219
E117392.....43	E117764.....221	E120302.....118	E130105.....130	E151004.....180	E160908.....107	E165422.....219
E117394.....43	E117767.....220	E120303.....118	E131601.....132	E154665.....178	E160909.....107	E165476.....108
E117395.....43	E117768.....130	E120304.....118	E131608.....132	E154667.....178	E160910.....218	E165479.....108
E117688.....61	E117771.....131	E120305.....118	E131609.....135	E154668.....178	E160911.....218	E165480.....108
E117700.....26	E117772.....131	E120901.....122	E131701.....128	E154669.....178	E160912.....218	E165481.....108
E117701.....26	E117773.....131	E121101.....119	E131702.....129	E154670.....178	E160920.....113	E165482.....108
E117702.....26	E117774.....131	E121102.....122	E131705.....128	E154672.....178	E160921.....113	E165483.....108
E117703.....26	E117775.....131	E121103.....122	E131709.....128	E154673.....178	E160922.....113	E165484.....109
E117704.....26	E117776.....131	E121105.....127	E131710.....129	E154674.....178	E160923.....113	E165490.....132
E117705.....26	E117777.....131	E121215.....126	E140101.....173	E160101.....108	E160924.....112	E168733.....135
E117706.....26	E117778.....131	E121216.....126	E140102.....173	E160102.....108	E160926.....114	E169804.....206
E117707.....26	E117779.....131	E121217.....126	E140103.....173	E160103.....108	E161101.....220	E184179.....168
E117708.....26	E117780.....131	E121218.....126	E140104.....173	E160104.....108	E161102.....222	E184181.....168
E117709.....26	E117781.....131	E121219.....126	E140105.....173	E160201.....108	E161108.....222	E184182.....168
E117710.....26	E117782.....131	E121220.....126	E140106.....173	E160202.....108	E161109.....223	E184195.....191
E117711.....26	E117783.....131	E121221.....126	E140601.....174	E160203.....108	E161110.....116	E184280.....221
E117712.....26	E117784.....131	E121222.....126	E140801.....174	E160204.....108	E161111.....116	E184302.....168
E117713.....26	E117785.....131	E121223.....126	E140902.....175	E160205.....108	E161112.....135	E184690.....162
E117714.....26	E117786.....131	E121224.....126	E142301.....173	E160206.....108	E161113.....135	E187366.....44
E117715.....26	E117787.....131	E121226.....126	E142302.....173	E160250.....114	E161114.....174	E187368.....44
E117716.....26	E117816.....120	E121227.....126	E142303.....173	E160252.....114	E161115.....134	E187470.....44
E117717.....26	E117820.....209	E121228.....126	E142401.....172	E160253.....114	E164978.....108	E187472.....44
E117718.....26	E117821.....209	E121229.....125	E150101.....179	E160254.....114	E164983.....108	E187473.....44
E117719.....26	E117822.....209	E121230.....125	E150102.....179	E160255.....114	E165006.....108	E189871.....165
E117720.....27	E117823.....209	E121501.....116	E150103.....179	E160256.....114	E165016.....108	E189872.....165
E117721.....27	E117824.....209	E121502.....116	E150104.....179	E160301.....110	E165017.....108	E189874.....164
E117722.....27	E117825.....209	E121503.....116	E150105.....179	E160302.....110	E165093.....108	E189874.....214
E117723.....27	E117827.....210	E121504.....116	E150106.....179	E160303.....110	E165096.....108	E189875.....163
E117724.....27	E117828.....210	E121505.....116	E150107.....179	E160304.....110	E165098.....108	E194672.....55

E194675.....	56	E200231.....	232	E200911.....	249	E201514.....	262
E194676.....	253	E200234.....	235	E201001.....	250	E201515.....	261
E194677.....	81	E200235.....	235	E201002.....	250	E201516.....	261
E194678.....	67	E200236.....	233	E201003.....	250	E201518.....	261
E194680.....	57	E200237.....	233	E201100.....	253	E201519.....	204
E194682.....	95	E200238.....	233	E201105.....	253	E201519.....	263
E194683.....	95	E200239.....	236	E201109.....	251	E201520.....	204
E194738.....	17	E200240.....	210	E201110.....	251	E201520.....	263
E194937.....	24	E200241.....	210	E201112.....	251	E201521.....	257
E194938.....	33	E200244.....	232	E201113.....	254	E201522.....	262
E194940.....	106	E200245.....	235	E201114.....	254	E201701.....	244
E194941.....	107	E200301.....	237	E201115.....	252	E201702.....	245
E194943.....	166	E200302.....	237	E201116.....	252	E201801.....	240
E194944.....	161	E200303.....	237	E201117.....	251	E201802.....	242
E195561.....	189	E200306.....	238	E201118.....	251	E201803.....	241
E195568.....	189	E200307.....	237	E201119.....	251	E201804.....	242
E195569.....	189	E200310.....	238	E201120.....	252	E201805.....	240
E200103.....	228	E200311.....	237	E201121.....	253	E201806.....	242
E200105.....	228	E200312.....	237	E201122.....	252	E201808.....	239
E200106.....	228	E200401.....	239	E201123.....	252	E201901.....	247
E200107.....	228	E200403.....	239	E201124.....	252	E201902.....	247
E200108.....	228	E200404.....	239	E201125.....	251	E214563.....	190
E200109.....	228	E200405.....	240	E201201.....	255	E220104.....	18
E200110.....	228	E200407.....	240	E201202.....	255	E220107.....	18
E200114.....	229	E200408.....	239	E201203.....	255	E230104.....	142
E200116.....	230	E200501.....	243	E201204.....	255	E230110.....	142
E200117.....	228	E200502.....	245	E201205.....	256	E230115.....	143
E200118.....	228	E200503.....	238	E201206.....	256	E230116.....	143
E200119.....	228	E200504.....	243	E201207.....	256	E230120.....	143
E200122.....	228	E200505.....	243	E201209.....	263	E230125.....	144
E200123.....	228	E200506.....	243	E201211.....	256	E230126.....	144
E200124.....	229	E200507.....	243	E201403.....	197	E230201.....	146
E200131.....	206	E200508.....	243	E201406.....	199	E230202.....	146
E200131.....	229	E200509.....	243	E201408.....	200	E230203.....	147
E200135.....	228	E200510.....	243	E201409.....	201	E230204.....	147
E200136.....	228	E200511.....	245	E201410.....	201	E230301.....	127
E200137.....	256	E200512.....	230	E201411.....	196	E230301.....	249
E200140.....	228	E200513.....	52	E201412.....	196	E230402.....	144
E200141.....	228	E200514.....	78	E201413.....	201	E230502.....	145
E200143.....	229	E200515.....	79	E201414.....	199	E230503.....	145
E200144.....	229	E200516.....	79	E201414.....	231	E230508.....	145
E200145.....	229	E200517.....	244	E201415.....	198	E230603.....	146
E200201.....	236	E200518.....	246	E201424.....	197	E230901.....	145
E200202.....	233	E200519.....	244	E201425.....	197	E231015.....	142
E200203.....	234	E200520.....	246	E201426.....	200	E231101.....	149
E200204.....	234	E200521.....	244	E201427.....	198	E231102.....	149
E200205.....	234	E200522.....	79	E201429.....	200	E231103.....	153
E200206.....	234	E200523.....	245	E201431.....	197	E418226.....	182
E200207.....	234	E200524.....	243	E201432.....	198	E418227.....	182
E200208.....	234	E200525.....	243	E201501.....	257	E418228.....	182
E200209.....	234	E200526.....	243	E201502.....	257	E418230.....	182
E200210.....	234	E200601.....	247	E201503.....	257	E418231.....	182
E200211.....	234	E200901.....	248	E201504.....	258	E418232.....	182
E200212.....	234	E200902.....	248	E201505.....	259	E418233.....	182
E200213.....	234	E200903.....	248	E201506.....	259	E418234.....	182
E200214.....	234	E200904.....	249	E201507.....	258	E418235.....	182
E200215.....	234	E200905.....	249	E201508.....	259	E418236.....	182
E200216.....	234	E200906.....	250	E201509.....	260	E469262.....	117
E200219.....	235	E200907.....	248	E201510.....	260	E469263.....	117
E200227.....	232	E200908.....	250	E201512.....	239	E501201.....	223
E200228.....	232	E200909.....	248	E201512.....	260	E501202.....	223
E200229.....	236	E200910.....	249	E201513.....	262	E501203.....	223



Centro logístico europeu – Dammariville (39), França

OS SEUS CONTACTOS EXPERT

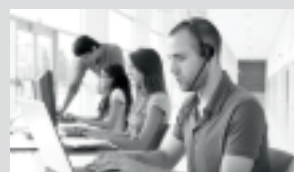

PT

Black & Decker Limited, S.a.r.l - Sucursal em Portugal

Quinta da Fonte - Edifício Q55 D. Diniz
Rua dos Malhões, 2 e 2A - Piso 2 E
2770 - 071 Paço de Arcos - Portugal
Telef.: 21 4667500 - Fax: 21 4667580 / facomherramientas@sbdinc.com

